

OCA [Signature]

City of Tuscaloosa
Tuscaloosa, Alabama



OFFICE OF THE CITY ATTORNEY

Project: THE EDGE BUSINESS RESOURCE CENTER
TRADE PACKAGE 8 - PLUMBING

Dept.: INFRASTRUCTURE AND PUBLIC SERVICES-ADMINISTRATION DIVISION

Contractor: TURNER PLUMBING, INC.

OCA File No. A16-1320

CITY OF TUSCALOOSA, ALABAMA
PUBLIC WORKS CONTRACT DOCUMENTS

WALTER MADDOX, MAYOR
CITY COUNCIL OF TUSCALOOSA

Council Members:

Phyllis Odom
Harrison Taylor
Cynthia Almond
Matthew Calderone
Kip Tyner
Edwin Pugh
Sonya McKinstry

Glenda Webb, City Attorney

PROJECT: The EDGE Business Resource Center
Trade Package 8 – Plumbing

PROJECT NUMBER: A16-1320

FOR: Infrastructure and Public Services-Administration Division

(2017)

ADOPTED
APPROVED AS TO FORM

Office of the City Attorney

Prepared By: KLM
Requested: Projects
Presentation on: 04/25/17
Suspension of Rules: NO

RESOLUTION

RESOLUTION TENTATIVELY AWARDING CONTRACT FOR A PUBLIC
WORKS OR PUBLIC IMPROVEMENT PROJECT AS FOLLOWS:
THE EDGE BUSINESS RESOURCE CENTER PROJECT CONSTRUCTION
(A16-1320)

WHEREAS, heretofore, bids were opened and read on or about the 30th day of March, 2017, in regard to THE EDGE BUSINESS RESOURCE CENTER PROJECT CONSTRUCTION; and,

WHEREAS, representatives of the City have notified the City Council Projects Committee of the apparent lowest bidder meeting the specifications for each trade package and the Public Projects Committee has recommended bid award to those trades; and,

WHEREAS, the representatives of the City have advised the City Council of that fact and recommended that they be authorized to issue notification of intention to award to the said bidders and upon all contractual matters being finalized including bonds and insurance, that the Mayor be authorized to execute all appropriate contracts and documents with said bidders.

NOW, THEREFORE, BE IT RESOLVED BY THE CITY COUNCIL OF TUSCALOOSA as follows:

1. That in accordance with ALA. CODE §39-5-1(b) (1975), the City of Tuscaloosa, as the awarding authority, does hereby certify that to the best of its knowledge, information and belief, this contract was let in compliance with applicable provisions of this title and all other applicable provisions of law.

2. That a conditional award based upon competitive bid is hereby made to the following Trade Contractors:

Trade Package No. 1, Site Work – Dominion Construction in the amount of \$864,521.73

Trade Package No. 2, General – K & A Builders in the total amount of \$3,051,000.00, which includes a base bid of \$2,798,000.00, Alternate No. 1 in the amount of \$230,000.00, Alternate No. 3 in the amount of \$12,000.00 and Alternate No. 4 in the amount of \$11,000.00.

Trade Package No. 3, Masonry – Garrett Masonry in the total amount of \$599,700.00, which includes a base bid of \$593,300.00 and Alternate No. 4 in the amount of \$6,400.00.

Trade Package No. 4, Roofing – Deason, Inc. in the amount of \$357,575.00

Trade Package No. 5, Drywall – Tuscaloosa Acoustical Systems in the amount of \$566,000.00

Trade Package No. 6, Fire Sprinkler– United States Sprinkler in the amount of \$72,050.00

Trade Package No. 7, HVAC – Premier Service. Co. in the total amount of \$352,661.00, which includes a base bid of \$303,911.00 and Alternate No. 2 in the amount of \$48,750.00.

Trade Package No. 8, Plumbing – Turner Plumbing in the amount of \$178,500.00

Trade Package No. 9, Electrical – Black Electrical Contractors in the total amount of \$1,074,100.00, which includes a base bid of \$1,067,200.00, Alternate No. 1 in the amount of \$3,350.00 and Alternate No. 4 in the amount of \$3,550.00.

Total \$7,116,107.73

pursuant to the plans, specifications, drawings and related documents for the project, as the apparent lowest responsible, responsive bidders taking into consideration where appropriate, the qualities of the commodities, the labor, service, etc., conformity with specifications, the purpose for which required, the terms of delivery, transportation charges and dates of delivery where applicable.

3. That the representatives of the City, on behalf of the City of Tuscaloosa be, and they are hereby, authorized to issue notification of intention of award to the said respective Trade Bidder in said amount and proceed with completion of review and submittal for all contractual matters as required by the City's plans and specifications.

4. That this award is conditioned upon each said bidder separately completing and submitting to the City through its representatives, all documents and other related matters required by the request for proposal of the bidder and upon notification from the City representatives that the bidder has complied with said requirements, the Mayor be, and he is hereby, authorized to execute a contract between the City of Tuscaloosa and respective Trade Bidder for the project in the amount awarded above, by and as an act for and on behalf of the City of Tuscaloosa, and the City Clerk be, and she is hereby, authorized to attest the same, at which time the contract will be considered to have been awarded.

5. That upon notification from the City representatives that all preliminary matters have been complied with by the said low bidder and subsequent execution of said contract by the Mayor on behalf of the City, the engineer be, and it is hereby, authorized to issue appropriate notices to proceed to the Contractor.

6. That this bid award is subject to meeting all federal procurement processes and procedures.

FUNDING REQUIRED: Yes No
DR# 2 \$ 2,264,109 ✓
ADECA #2 \$ 3,600,000
EDA \$ 5,061,440
UA Cost Reimbursement \$ 12,047
By: W. K. [Signature]
Finance Director

COUNCIL ACTION
Resolution _____
Passed 4-25-17
Failed _____
Tabled _____
Amended _____
Comments: _____



ADDENDUM NO. 1:

Date: February 20, 2017
 Project: The EDGE Business Resource Center
 Owner: The City of Tuscaloosa
 Owner's Project No: A16-1320 (Previously City #A14-1210)
 Architect: Ward Scott Architecture, Inc.

This Addendum forms a part of the Contract Documents and modifies the original Bid Documents dated July 30, 2015, as noted below.

Acknowledge receipt of this Addendum in the location provided on the Bid Proposal Form.

The Pre-Bid conference scheduled for Wednesday, March 8, 2017 at 10am as advertised. It will be held at Narashino Room of Tuscaloosa City Hall, 2201 University Boulevard, Tuscaloosa, Alabama 35401. Attendance at the Pre-Bid Conference is mandatory in order to submit a bid for this project.

1.1 GENERAL

A. Remove all references to Deborah Roy Design, LLC in the project drawings and specifications.

1.2 SPECIFICATIONS AND DRAWINGS

A. Specifications

1. Refer to Hardware Section #08710 – Hardware Schedule, page 11 – HS23. Delete twelve doors from the project and their associated HW23 set: # 130A, 140A, 140B, 141A, 141B, 142A, 143A, 144A, 145A, 145B, 146A and 146B.

B. Drawings – Revision #1 dated February 7, 2017 Attached Drawings:

1. Refer to Cover Sheet G101. Modify the City Project Number to A16-1320.
2. Refer to Room Finish Schedule Sheet A001. Delete the following rooms and associated room finishes from the Schedule: Open Studio #157, Open Studio #158, Office #139, Office #140, Office #141, Office #142, Office #143, Office #144, Office #145 and Office #146. Modify the finishes for Open Studio #153 as shown on the revised room finish schedule. Add marker paint, #XXXX at Open Studio #153 north wall.
3. Refer to Sheet A002 Opening Schedule and Elevations. Delete twelve doors from the opening schedule: #130A, 140A, 140B, 141A, 141B, 142A, 143A, 144A, 145A, 145B, 146A and 146B.
4. Refer to Drawing 1 Floor Plan Sheet A101. Delete the walls and doors associated with the following room numbers: Open Studio #157, Open Studio #158, Office #139, Office #140, Office #141, Office #142, Office #143, Office #144, Office #145 and Office #146. The north wing area to be renamed as Open Studio #153 as shown on the revised floor plan. The wall partition located at the north end of room #153 Open Studio to remain at 9'0" A.F.F.
5. Refer to Drawing #1 Furniture Plan Sheet A102. The furniture shown at the Open Studio #157, Open Studio #158, Office #139, Office #140, Office #141, Office #142, Office #143, Office #144, Office #145 and Office #146 will be modified by the owner's furniture vendor. Delete the reference to furniture on the floor plan at this north wing area and the offices that have been deleted per item #3 above Refer to electrical for receptacle, data and lighting revisions.
6. Refer to #2 Building Section 2 on Sheet A301. Delete the wall partition and modify the ceiling at the deleted office locations. The wall partition located at the north end of room #153 Open Studio is shown at 9'-0" AFF.
7. Refer to #2 Building Section 4 on Sheet A302. Delete the wall partitions and doors at Office #140, #142, #144, #146, and modify ceiling as shown at acoustic tile suspended system.
8. Refer to #5 Open Studio 153 North on Sheet A401. Modify Soffit above the coffee area extend 6" beyond the partition wall located at the coffee counter.

9. Refer to #13 Open Studio 158 North on Sheet A402. Omit this elevation.
10. Refer to #6 Open Studio 153 Looking West on Sheet A401. Modify the view and drawing title to: Open Studio 155 Looking North.
11. Refer to #1 Level 1 Ceiling Plan on Sheet A501. The suspended ACT ceiling system at the center of Open Studio #153 to be a continuous ceiling area where the center office wall partitions were removed. Delete the AC-PNL-C Armstrong Soundscapes Blades Linear Acoustic Panels in entirety. Replace with Armstrong 10" Axiom Aluminum Perimeter Trim with suspended lay-in acoustical panels as shown on revised Ceiling Plan. Refer to electrical for lighting changes.
12. Refer to #1 First Floor Pattern Plan-B on Sheet A602. Modify the carpet floor patterning as indicated on revised drawing at the north wing Open Studio #153.

1.3 ATTACHED TO ADDENDUM

- A. Architectural Sheets G101, A001, A002, A101, A102, A301, A302, A401, A402, A501 and A602.
- B. RH Smith and Associates Addendum and Revised Sheets P102, M101, E001, E003, E101, E201, and E301.
- C. TALA Professional Services Addendum, Revised Specification Sections 272100, 272110, and Revised Sheets TD101, TD102, TD201, TD301, TD302, TD303, and TD304.

END OF ADDENDUM

ADDENDUM



Smith, Stegall & associates p.c.

◆
Consulting Engineers

◆
2110 Eighth Street, Tuscaloosa, AL 35401

◆
Phone/Fax 205 345 4402

PROJECT: The Edge Business Resource Center	ENG JOB # 1436	DATE: February 16, 2017
--	--------------------------	-----------------------------------

MECHANICAL:

1. Sheet M101, diffusers and return grilles serving individual offices removed. Open office area now served by 2-24x24" CD diffusers and return grille on remaining office wall. Thermostats on removed wall moved to new locations.

PLUMBING:

1. Sheet P102, pressure piping in removed wall shifted to wall directly plan south.

ELECTRICAL:

1. Sheet E001: (Sheet Reissued) See attached sheet for clouded revisions.
2. Sheet E003, Panel 'A' Schedule: (Sheet Reissued) See attached sheet for clouded revisions.
3. Sheet E101, Power Wiring Plan: (Sheet Reissued) See attached sheet for clouded revisions.
4. Sheet E201, Lighting Plan: (Sheet Reissued) See attached sheet for clouded revisions.
5. Sheet E300, Auxiliary Symbols: Add the following symbol:

⊗ AUDIBLE VISUAL INDICATING DEVICE, HORN, SYNCHRONIZED FLASH, CEILING MOUNT, SUFFIX INDICATES CANDELA SETTING, NO SUFFIX - 15 CANDELA

6. Sheet E301, Auxiliary Plan: (Sheet Reissued) See attached sheet for clouded revisions.

END OF ADDENDUM

MEMORANDUM

TO: Kim McMurray, Ward Scott Architecture
Jordan Morris, Ward Scott Architecture

FROM: Tim Lewis, TALA Professional Services
Terry Weaver, TALA Professional Services

SUBJECT: THE EDGE Project – Addendum #1 – IT/ Telecommunications

DATE: February 7, 2017

Specification Section 272100, Data Communications Network Equipment

1. Re-issued section in its entirety. (Replace Section 272100)
Noted clarifications to specs for the contractors.

Specification Section 272110, Data Communications Network Equipment/ Outdoor Switches

1. Re-issued section in its entirety. (Replace Section 272110)
Changed/ Removed Contractor furnished and installed equipment to Owner
Furnished and Contractor installed equipment. Noted clarifications to specs for the contractors.

Sheet TD101, DataCom/ Telecom. Data Floor Plan Drawing

1. Re-issued drawing in its entirety. (Replace Drawing TD101)
2. Corrected Floor Box Layout on the Data Floor Plan to agree with the removal of offices and changing to the Open Studio #153 North Wing Area.
3. Re-locate/ Re-position (16) Floor Boxes in Open Studio #153 Area. North Wing.
 - (6) D2/FB with 12 Cat6 OSP Cable Drops in Open Studio #137 East/ North Wing
Change from (6) D2/FB to (6) D4/FB.
 - (5) D4/FB with 20 Cat6 OSP Cable Drops in Open Studio #137 East/ North Wing
To remain as (5) D4/FB.
 - (3) D4/FB with 12 Cat6 OSP Cable Drops in Open Studio #137 West/ North Wing
Wing
To remain as (3) D4/FB.
 - (2) D6/FB with 12 Cat6 OSP Cable Drops in Open Studio #137 West/ North Wing

Change from (2) D6/FB to (2) D4/FB.

(All to be Re-positioned in Open Studio #153 Area.)

4. Add and Position (14) Floor Boxes in Open Studio #153 Area. North Wing.
(14) D4/FB with 56 Cat6 OSP Cable Drops in Open Studio #153/ North Wing
(All to be Positioned in Open Studio #153 Area.)
5. Re-locate/ Re-position (2) D4/ Wall Boxes in Open Studio #153 Area. North Wing.
(2) D4/ Wall Boxes with 8 Cat6 ISP Cable Drops in Open Studio #153/ North Wing
(All to be Re-positioned in Open Studio #153 Area.)
6. Add and Position (4) Wall Boxes in Open Studio #153 Area. North Wing.
(4) D4/ Wall Boxes with 16 Cat6 ISP Cable Drops in Open Studio #153/ North Wing
(All to be Positioned in Open Studio #153 Area.)
7. Delete (6) Wall Boxes in Open Studio #137 South Area. North Wing.
(6) D2/ Wall Boxes with 12 Cat6 ISP Cable Drops in Open Studio #137/ North Wing
8. Delete (16) Wall Boxes in Rooms #139, #140, #141, #142, #143, #144, #145 and #146 North Wing.
(16) D2/ Wall Boxes with 32 Cat6 ISP Cable Drops in North Wing.

Summary-

- A. Reposition (16) Floor Boxes in Open Studio #153.
- B. Add (14) New Floor Boxes in Open Studio #153.
- C. Reposition/ Reallocate (56) Cat6 OSP Cable Drops in floor boxes.
- D. Add (64) Cat6 OSP Cable Drops in floor boxes.
- E. Reposition/ Reallocate (24) Cat6 ISP Cable Drops in wall outlets.
- F. Delete (28) Cat6 ISP Cable Drops in wall outlets.
- G. Reposition (6) Wall Boxes with conduit in Open Studio #153.
- H. Delete (18) Wall Boxes with conduit.

Sheet TD102, DataCom/ Telecom. Audio Visual Floor Plan Drawing

1. Re-issued drawing in its entirety. (Replace Drawing TD102)
2. Corrected Floor Box Layout on the AV Floor Plan to agree with the removal of offices and changing to the Open Studio #153 North Wing Area.

Sheet TD201, Room/ Cabinet/ Fiber Layout Detail Drawing

1. Re-issued drawing in its entirety. (Replace Drawing TD201)
2. No scope change, updated drawing to indicate fiber information and fiber cable identification labeling.
3. Added Work Operation Numbers for clarifications for the contractors.
4. Added TDV #1 vault and size 18"x 24"x 28" to drawing.
5. Corrected FODPU Layout and Information on the drawing.

Sheet TD301, Security Camera Site Layout Drawing

1. Re-issued drawing in its entirety. (Replace Drawing TD301)

2. No scope change, updated drawing to indicate fiber routing and fiber cable identification labeling.
3. Added contractor notes for clarifications for the contractors.
4. Added Work Operation Numbers for clarifications for the contractors.
5. Added Work Operation directions in placement notes for clarifications for the contractors.
6. Corrected Work Operation No. 7, TDV #1 vault size from 18"x 24"x 48" to 18"x 24"x 28".

Sheet TD302, Typical Pole Detail Drawing

1. Re-issued drawing in its entirety. (Replace Drawing TD302)
2. No scope change, updated detail drawings. Noted clarifications to notes for the contractors.

Sheet TD303, Typical IT-Cabinet Detail Drawing

1. Re-issued drawing in its entirety. (Replace Drawing TD303)
2. No scope change, updated detail drawings. Noted clarifications to notes for the contractors.

Sheet TD304, Typical Pole Portals Opening Detail Drawing

1. Re-issued drawing in its entirety. (Replace Drawing TD304)
2. No scope change, updated detail drawings. Noted clarifications to notes for the contractors.

End of IT/ Telecommunications Addendum

**CITY of TUSCALOOSA
EDGE BUILDING PROJECT**

SECTION 272100 – DATA COMMUNICATIONS NETWORK EQUIPMENT

PART 1 - GENERAL

1.1 SPECIAL SERVICES / SYSTEMS

- A. The data communications network equipment systems (Cisco Network Switch, Security Cameras, and Wireless Access Point Units) are to be provided by the Owner for this project. It will not be the responsibility of the telecommunications special systems contractor to provide or install this equipment.**

PART 2 - PRODUCTS (Not Applicable)

PART 3 - EXECUTION (Not Applicable)

END OF SECTION 272100

SECTION 272110 – DATA COMMUNICATIONS NETWORK EQUIPMENT/ OUTDOOR SWITCHES

PART 1 - GENERAL

1.1 DATA COMMUNICATIONS NETWORK EQUIPMENT/ OUTDOOR SWITCHES

- A. Contractor shall install a fully functioning outdoor network system as specified herein.
- B. The system shall include all necessary equipment to create a totally functioning outdoor network system.
- C. Furnishing and installing a turnkey Outdoor Data Network solution utilizing Cat6 and fiber cabling and related peripheral equipment as indicated and specified herein, and connecting the system and related peripherals to the cabling infrastructure and network.
- D. All equipment and materials shall be new and shall be designed specifically for the work to be done.
- E. Interfacing the system with the network and coordinating the installation of all required facilities, including the disconnection of all existing services and the re-connection of the new services at the new location with the Service Provider.
- F. For purpose of this project, Supplier shall assume that it will be expected to expend the labor to coordinate and manage the implementation of new carrier facilities and identifying and managing the disconnection of services that will no longer be required after cutover.
- G. All equipment described herein shall be the products of manufacturers as described herein.
- H. The Contractor/ Vendor must provide in the Contract, as a minimum, a one-year warranty on the proposed system(s), labor and those materials, and parts supplied by the Contractor unless stated otherwise in this document. The warranty will cover the contractor supplied parts/ equipment, labor, travel and miscellaneous costs. The warranty period will commence the day following the date of System Acceptance. The Vendor shall comply with this statement unless requirements differ for specific items as indicated below.
- I. If the system fails to completely perform in accordance with the specifications and the contract documents, the contractor will take all necessary action, at no additional cost, to restore the system to perform in accordance with the system specification requirements and the contract documents.
- J. The data concerning the IT-Cabinet with all hardware, NEMA J-Box, Seal-tight conduit connections to the NEMA J-Box, Fiber and LIU/FODPU, CAT-6 Station Cable and Termination Box,(Under Division 270000) that are provided on the drawing documents are the – Telecommunications Vendor/Contractor's Responsibility.
- K. The data concerning the underground conduit and QB/ Vaults, Innerducts and the Electrical Receptacle/Outlet in the IT-Cabinets/ Pole Mounted are (Under Division 260000) as well as the Ground Bar that are provided on the drawing documents are the – Electrical Contractor's Responsibility.
- L. The Installation of all Outdoor Network Data Switches and Power Supplies with all Mounts and Mounting Hardware/Din Rail, Power Connections to the equipment, Ground Connections to the

CITY of TUSCALOOSA
EDGE BUILDING PROJECT

equipment, Fiber Patch Cords and the CAT-6 Patch Cords in the IT-Cabinet are the Data Network-Vendor/Contractor's Responsibility.

M. All Fiber and CAT-6 Patch Cords are being provided under this contract. All Patch Cords will be provided by the Vendors/Contractor for installation.

1.2 NETWORK EQUIPMENT SYSTEM INSTALLATION

- A. Contractor/ Vendor shall install (3/ Three -Owner Provided Transitions Network Switches and Power Supplies) Outdoor Network Equipment System.
- B. Contractor/ Vendor shall install (1-Owner Provided Fiber Network Cisco Switches and Eaton (2) 9130-2000 UPS Unit/Battery Rack Mount Units in the Eqmt. Cabinet) Indoor Network Equipment System in the Edge Building.
- C. Contractor/ Vendor shall be responsible for the installation of the Network Equipment, the City IT-Department shall provide equipment and program the system.
- D. Contractor/ Vendor shall coordinate and set up all network records including IP Number assignments and MAC Addresses all devices connected to the network.
- E. The Contractor/ Vendor shall make up and provide an Industrial Grade Electrical Extension Cord 18" to 24" in length from the Transition Networks Power Supplies to the Electrical Outlet/Receptacle in each IT-Comm. Cabinet. There shall also be an Electrical Wiring Harness placed between the Transition Networks Switches and the Transition Networks Power Supplies for connection. The cords and harness shall be routed and neatly secured to the cabinet backboard.
- F. The Fiber Backbone/SM-OSP System is being installed under this contract.
- G. All Fiber and Cat-6 jumper/patch cords are being furnished under this contract.

PART 2 - PRODUCTS (Not Applicable)

PART 3 - EXECUTION (Not Applicable)

END OF SECTION 272110

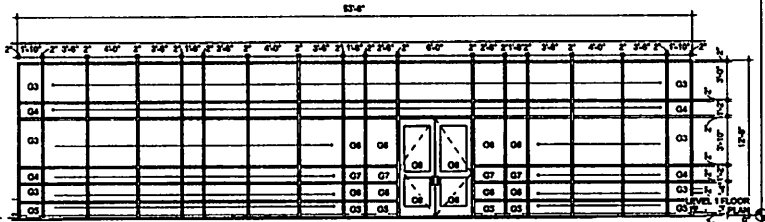

6 FRAME ELEVATION- SF5 SCALE: 1/4" = 1'-0"

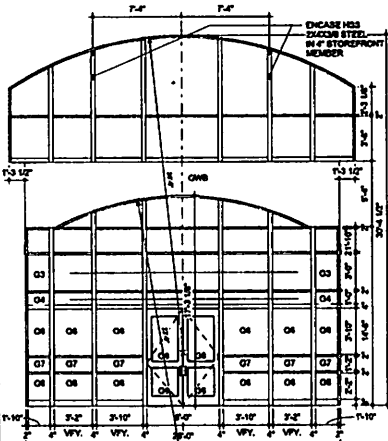

5 FRAME ELEVATION- SF2A SCALE: 1/4" = 1'-0"

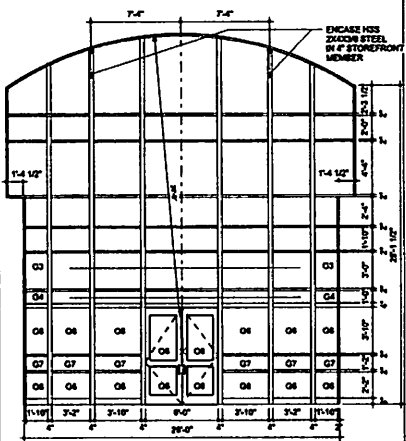

4 FRAME ELEVATION- SF2B SCALE: 1/4" = 1'-0"

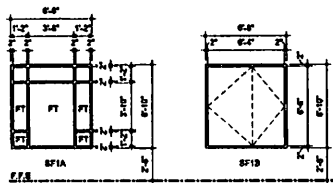

8 FRAME ELEVATIONS- SF1A SCALE: 1/4" = 1'-0"

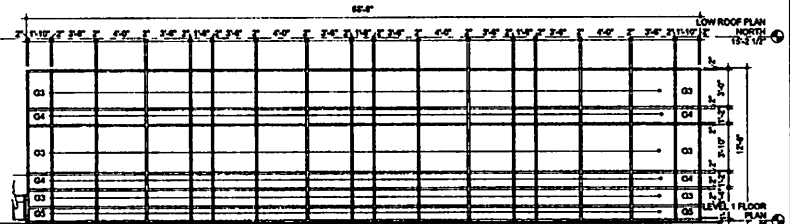

3 FRAME ELEVATION- SF4 SCALE: 1/4" = 1'-0"

DOOR SCHEDULE													
DOOR NUMBER	FIRE RATING	DOOR WIDTH	DOOR HEIGHT	DOOR ELEV.	DOOR MATERIAL	DOOR GLAZING	FRAME MATERIAL	FRAME GLAZING	HARDWARE	FINISH	COMMENTS		
101A		7'-0"	7'-0"	D3	ALUM	G1	SF10	ALUM	G1	MW7	D		
101AA		7'-0"	7'-0"	D3	ALUM	G1	SF14	ALUM	G1	MW10	E		
101BA		7'-0"	7'-0"	D3	ALUM	G1	SF16	ALUM	G1	MW10	E		
102A		7'-0"	7'-0"	D3	ALUM	G1	SF18	ALUM	G1	MW10	E		
102AA		7'-0"	7'-0"	D3	ALUM	G1	SF18	ALUM	G1	MW10	E		
102EA		7'-0"	7'-0"	D1	WC	**	F1	M4	**	MW22	C		
102EA		7'-0"	7'-0"	D1	WC	**	F1	M4	**	MW22	C		
102EA		7'-0"	7'-0"	D2	WC	G1	F1	M4	**	MW23	C		
102B		7'-0"	7'-0"	D3	ALUM	G2	SF8	ALUM	SEE ELEVATION	MW23	D		
102B		7'-0"	7'-0"	D1	WC	**	F1	M4	**	MW20	C		
102B		7'-0"	7'-0"	D1	WC	**	F1	M4	**	MW21	C		
102B		7'-0"	7'-0"	D1	WC	**	F1	M4	**	MW22	C		
102B		7'-0"	7'-0"	D1	WC	**	F1	M4	**	MW23	C		
102B		7'-0"	7'-0"	D1	WC	**	F1	M4	**	MW24	C		
102B		7'-0"	7'-0"	D1	WC	**	F1	M4	**	MW25	C		
102B		7'-0"	7'-0"	D1	WC	**	F1	M4	**	MW26	C		
102B		7'-0"	7'-0"	D1	WC	**	F1	M4	**	MW27	C		
102B		7'-0"	7'-0"	D1	WC	**	F1	M4	**	MW28	C		
102B		7'-0"	7'-0"	D1	WC	**	F1	M4	**	MW29	C		
102B		7'-0"	7'-0"	D1	WC	**	F1	M4	**	MW30	C		
102B		7'-0"	7'-0"	D1	WC	**	F1	M4	**	MW31	C		
102B		7'-0"	7'-0"	D1	WC	**	F1	M4	**	MW32	C		
102B		7'-0"	7'-0"	D1	WC	**	F1	M4	**	MW33	C		
102B		7'-0"	7'-0"	D1	WC	**	F1	M4	**	MW34	C		
102B		7'-0"	7'-0"	D1	WC	**	F1	M4	**	MW35	C		
102B		7'-0"	7'-0"	D1	WC	**	F1	M4	**	MW36	C		
102B		7'-0"	7'-0"	D1	WC	**	F1	M4	**	MW37	C		
102B		7'-0"	7'-0"	D1	WC	**	F1	M4	**	MW38	C		
102B		7'-0"	7'-0"	D1	WC	**	F1	M4	**	MW39	C		
102B		7'-0"	7'-0"	D1	WC	**	F1	M4	**	MW40	C		
102B		7'-0"	7'-0"	D1	WC	**	F1	M4	**	MW41	C		
102B		7'-0"	7'-0"	D1	WC	**	F1	M4	**	MW42	C		
102B		7'-0"	7'-0"	D1	WC	**	F1	M4	**	MW43	C		
102B		7'-0"	7'-0"	D1	WC	**	F1	M4	**	MW44	C		
102B		7'-0"	7'-0"	D1	WC	**	F1	M4	**	MW45	C		
102B		7'-0"	7'-0"	D1	WC	**	F1	M4	**	MW46	C		
102B		7'-0"	7'-0"	D1	WC	**	F1	M4	**	MW47	C		
102B		7'-0"	7'-0"	D1	WC	**	F1	M4	**	MW48	C		
102B		7'-0"	7'-0"	D1	WC	**	F1	M4	**	MW49	C		
102B		7'-0"	7'-0"	D1	WC	**	F1	M4	**	MW50	C		
102B		7'-0"	7'-0"	D1	WC	**	F1	M4	**	MW51	C		
102B		7'-0"	7'-0"	D1	WC	**	F1	M4	**	MW52	C		
102B		7'-0"	7'-0"	D1	WC	**	F1	M4	**	MW53	C		
102B		7'-0"	7'-0"	D1	WC	**	F1	M4	**	MW54	C		
102B		7'-0"	7'-0"	D1	WC	**	F1	M4	**	MW55	C		
102B		7'-0"	7'-0"	D1	WC	**	F1	M4	**	MW56	C		
102B		7'-0"	7'-0"	D1	WC	**	F1	M4	**	MW57	C		
102B		7'-0"	7'-0"	D1	WC	**	F1	M4	**	MW58	C		
102B		7'-0"	7'-0"	D1	WC	**	F1	M4	**	MW59	C		
102B		7'-0"	7'-0"	D1	WC	**	F1	M4	**	MW60	C		
102B		7'-0"	7'-0"	D1	WC	**	F1	M4	**	MW61	C		
102B		7'-0"	7'-0"	D1	WC	**	F1	M4	**	MW62	C		
102B		7'-0"	7'-0"	D1	WC	**	F1	M4	**	MW63	C		
102B		7'-0"	7'-0"	D1	WC	**	F1	M4	**	MW64	C		
102B		7'-0"	7'-0"	D1	WC	**	F1	M4	**	MW65	C		
102B		7'-0"	7'-0"	D1	WC	**	F1	M4	**	MW66	C		
102B		7'-0"	7'-0"	D1	WC	**	F1	M4	**	MW67	C		
102B		7'-0"	7'-0"	D1	WC	**	F1	M4	**	MW68	C		
102B		7'-0"	7'-0"	D1	WC	**	F1	M4	**	MW69	C		
102B		7'-0"	7'-0"	D1	WC	**	F1	M4	**	MW70	C		
102B		7'-0"	7'-0"	D1	WC	**	F1	M4	**	MW71	C		
102B		7'-0"	7'-0"	D1	WC	**	F1	M4	**	MW72	C		
102B		7'-0"	7'-0"	D1	WC	**	F1	M4	**	MW73	C		
102B		7'-0"	7'-0"	D1	WC	**	F1	M4	**	MW74	C		
102B		7'-0"	7'-0"	D1	WC	**	F1	M4	**	MW75	C		
102B		7'-0"	7'-0"	D1	WC	**	F1	M4	**	MW76	C		
102B		7'-0"	7'-0"	D1	WC	**	F1	M4	**	MW77	C		
102B		7'-0"	7'-0"	D1	WC	**	F1	M4	**	MW78	C		
102B		7'-0"	7'-0"	D1	WC	**	F1	M4	**	MW79	C		
102B		7'-0"	7'-0"	D1	WC	**	F1	M4	**	MW80	C		
102B		7'-0"	7'-0"	D1	WC	**	F1	M4	**	MW81	C		
102B		7'-0"	7'-0"	D1	WC	**	F1	M4	**	MW82	C		
102B		7'-0"	7'-0"	D1	WC	**	F1	M4	**	MW83	C		
102B		7'-0"	7'-0"	D1	WC	**	F1	M4	**	MW84	C		
102B		7'-0"	7'-0"	D1	WC	**	F1	M4	**	MW85	C		
102B		7'-0"	7'-0"	D1	WC	**	F1	M4	**	MW86	C		
102B		7'-0"	7'-0"	D1	WC	**	F1	M4	**	MW87	C		
102B		7'-0"	7'-0"	D1	WC	**	F1	M4	**	MW88	C		
102B		7'-0"	7'-0"	D1	WC	**	F1	M4	**	MW89	C		
102B		7'-0"	7'-0"	D1	WC	**	F1	M4	**	MW90	C		
102B		7'-0"	7'-0"	D1	WC	**	F1	M4	**	MW91	C		
102B		7'-0"	7'-0"	D1	WC	**	F1	M4	**	MW92	C		
102B		7'-0"	7'-0"	D1	WC	**	F1	M4	**	MW93	C		
102B		7'-0"	7'-0"	D1	WC	**	F1	M4	**	MW94	C		
102B		7'-0"	7'-0"	D1	WC	**	F1	M4	**	MW95	C		
102B		7'-0"	7'-0"	D1	WC	**	F1	M4	**	MW96	C		
102B		7'-0"	7'-0"	D1	WC	**	F1	M4	**	MW97	C		
102B		7'-0"	7'-0"	D1	WC	**	F1	M4	**	MW98	C		
102B		7'-0"	7'-0"	D1	WC	**	F1	M4	**	MW99	C		
102B		7'-0"	7'-0"	D1	WC	**	F1	M4	**	MW100	C		

G1:	1/4" CLEAR TEMPERED GLASS
G2:	1/4" FROSTED TEMPERED GLASS
G3:	1" INSULATED GLAZING UNIT WITH SOLAR COOL TINTING
G4:	1" INSULATED GLAZING UNIT WITH MOLAR COOL TINTING
G5:	1" INSULATED ALUMINUM PANEL
G6:	SAME AS G3 WITH TEMPERED GLAZING
G7:	SAME AS G4 WITH TEMPERED GLAZING

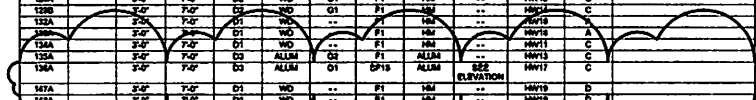

WARD SCOTT ARCHITECTURE
5715 Franklin Blvd
Tuscaloosa, AL 35401
www.ward-scott.com

THE EDGE BUSINESS RESOURCE CENTER
THE CITY OF TUSCALOOSA
2627 10TH AVENUE,
TUSCALOOSA, ALABAMA

DATE:	7-20-15	
PROJ. NO.:	13-073	
REVISIONS		
#	DESC	DATE
1	ADDENDA	09/17
2		

C:\Users\wardscott\Documents\LOCAL\13-07-15 THE EDGE-BUSINESS RESOURCE CENTER_ARCH\13-07-15 THE EDGE-BUSINESS RESOURCE CENTER_ARCH\13-07-15 THE EDGE-BUSINESS RESOURCE CENTER_ARCH\13-07-15 THE EDGE-BUSINESS RESOURCE CENTER_ARCH\FLOOR PLAN.dwg

Copyright Ward Scott Architects, Inc. All Rights Reserved 2/20/11 4:04:28 PM

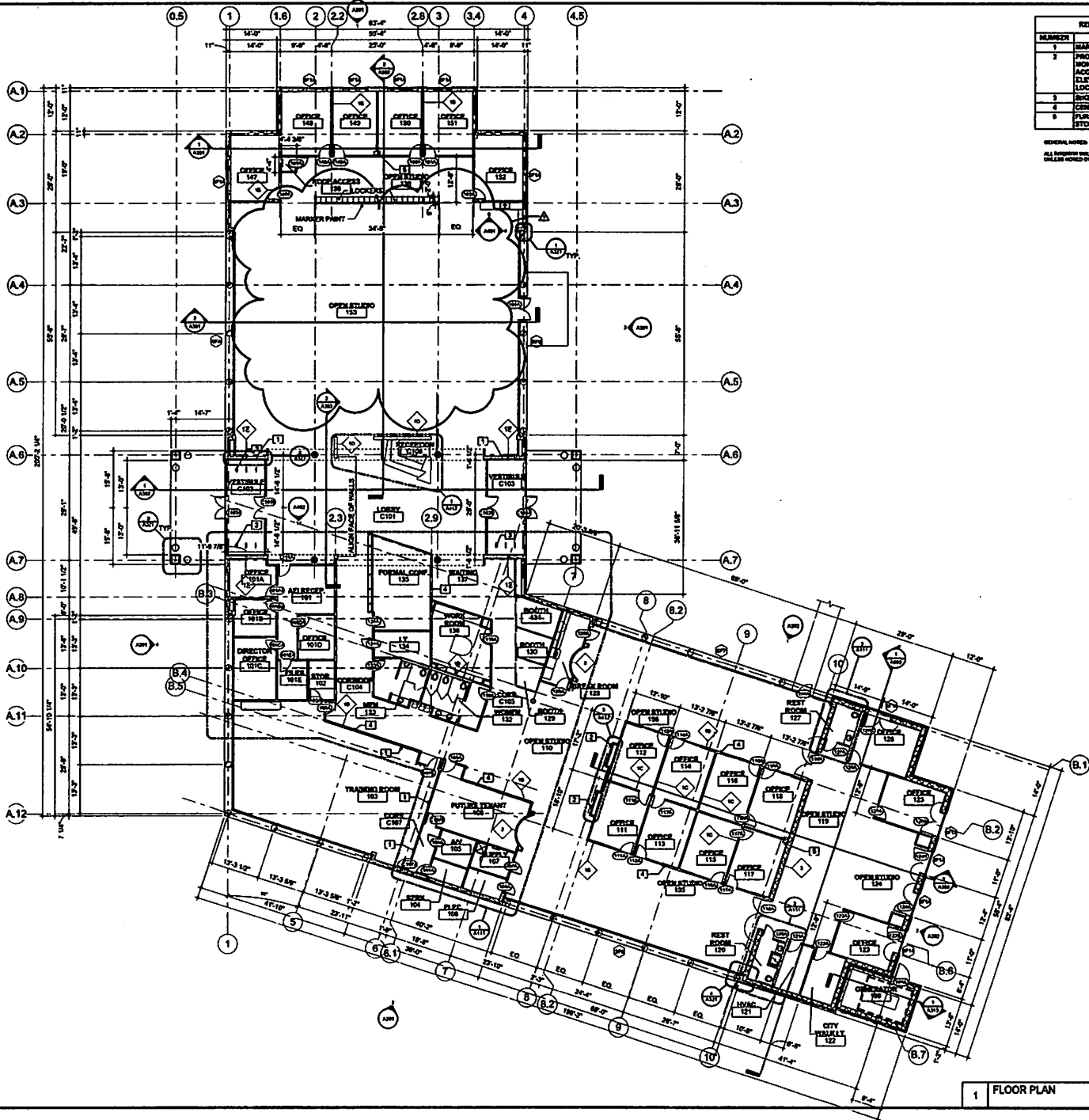

REFERENCE NOTES	
NUMBER	NOTE
1	MARKER BOARD
2	PROMEX BLOSSOM FOR MONITORS, PAPER TUBE MOUNT, ACOUSTICAL PANELS, ETC. SEE ELEV. OR EXCIP. & FINISHES LOCATIONS
3	BRICE RACK
4	CENTER WALL ON COOL. LINE
5	FLAME PARTITION AROUND STORE DRAINS

GENERAL NOTES
ALL PARTITION WALL PARTITIONS TO BE CONSTRUCTED IN GALEN HORN OVERWALL.



2716 South
Tuscaloosa, AL 35896
Phone: 205-756-2222
Fax: 205-756-2222

THE EDGE BUSINESS RESOURCE CENTER
THE CITY OF TUSCALOOSA
2827 10TH AVENUE,
TUSCALOOSA, ALABAMA

CONSTRUCTION DOCUMENTS		
DATE:	7-30-13	
PROJ NO:	13-073	
REVISIONS		
NO.	DESC.	DATE
1	ADDENDA	2/20/11
2		01

FLOOR PLAN

1 FLOOR PLAN SCALE: 3/32" = 1'-0"

A101



CONSTRUCTION DOCUMENTS
DATE: 02/20/13
PROJ. NO.: 13-077
REVISIONS:
NO. DESCRIPTION DATE
1 10/20/12 1/2012

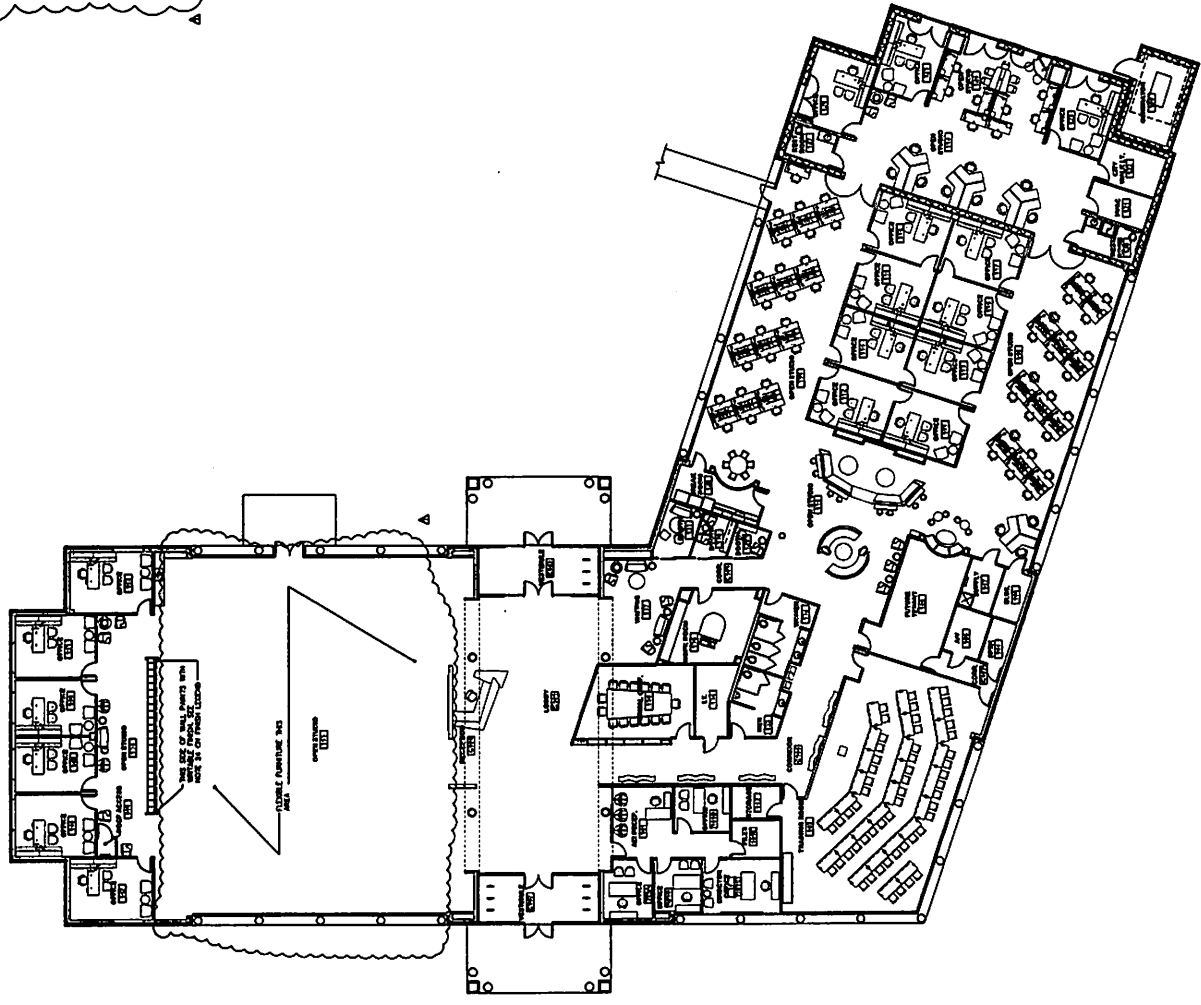

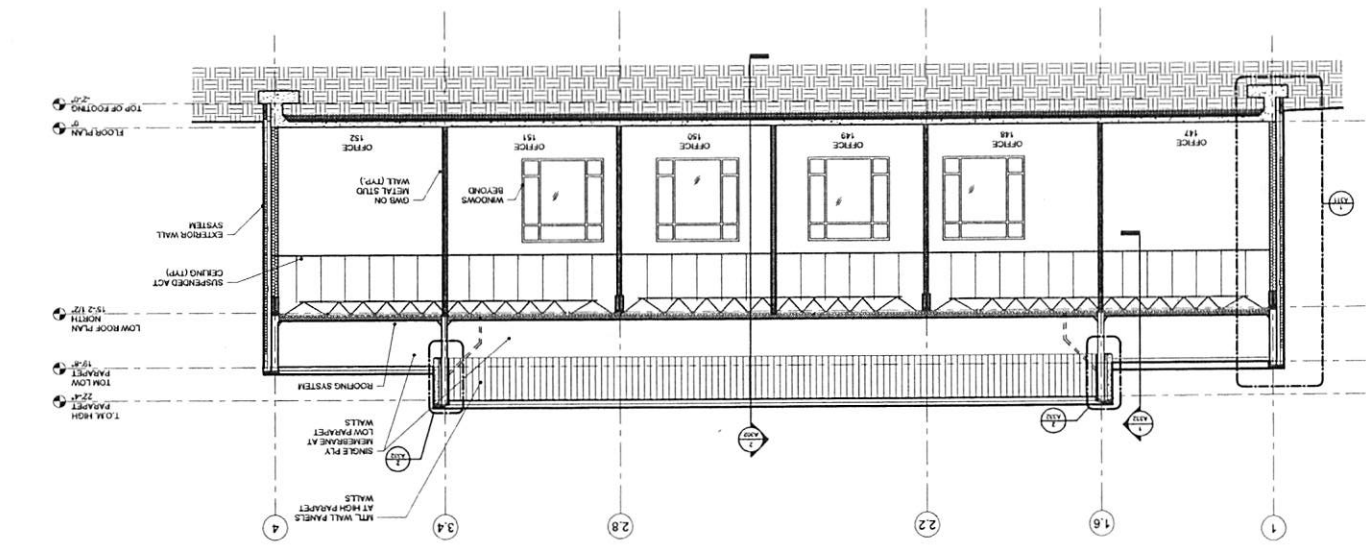
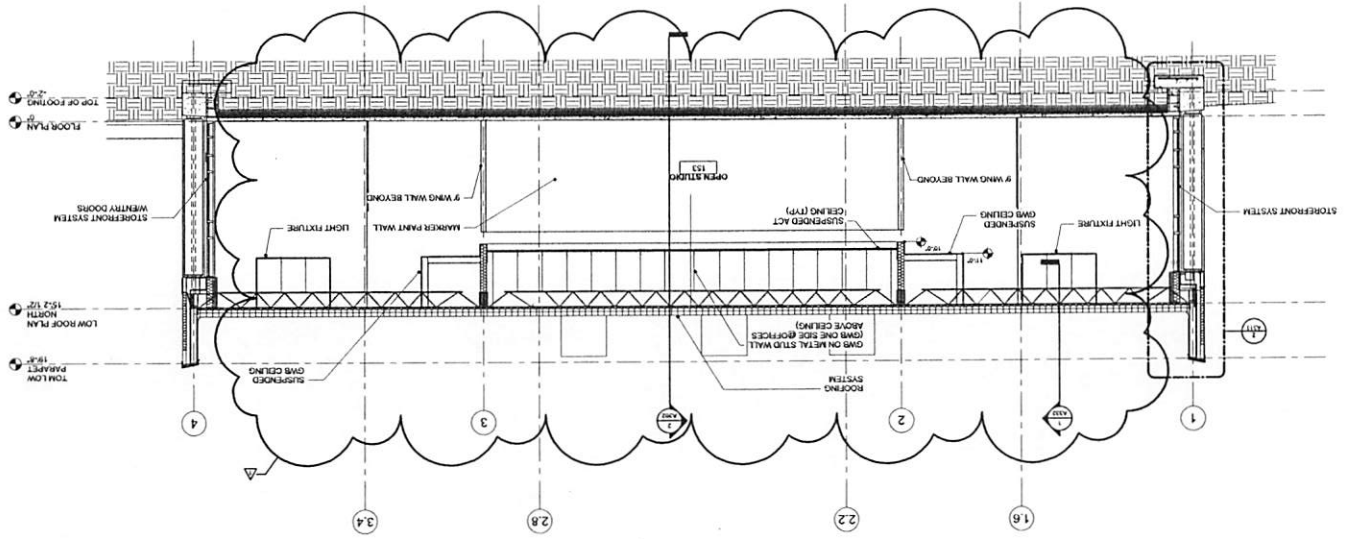

2 BUILDING SECTION 2 SCALE: 1/4" = 1'-0"

1 BUILDING SECTION 1 SCALE: 1/4" = 1'-0"

A301

REVISIONS	DATE	DESC
1	11/20/11	ADDITIONAL REV

CONSTRUCTION DOCUMENTS
 DATE: 7-26-11
 PROJ. NO. 13473

THE EDGE BUSINESS RESOURCE CENTER
 THE CITY OF TUSCALOOSA
 2627 10TH AVENUE
 TUSCALOOSA, ALABAMA



C:\Users\wardscott\Documents\LOCAL\13-073-THE EDGE-2016\CENTRAL_w\studio\plans\ssm\ssm.rvt

2/26/2017 4:04:48 PM

Copyright Ward Scott Architecture, Inc. All Rights Reserved

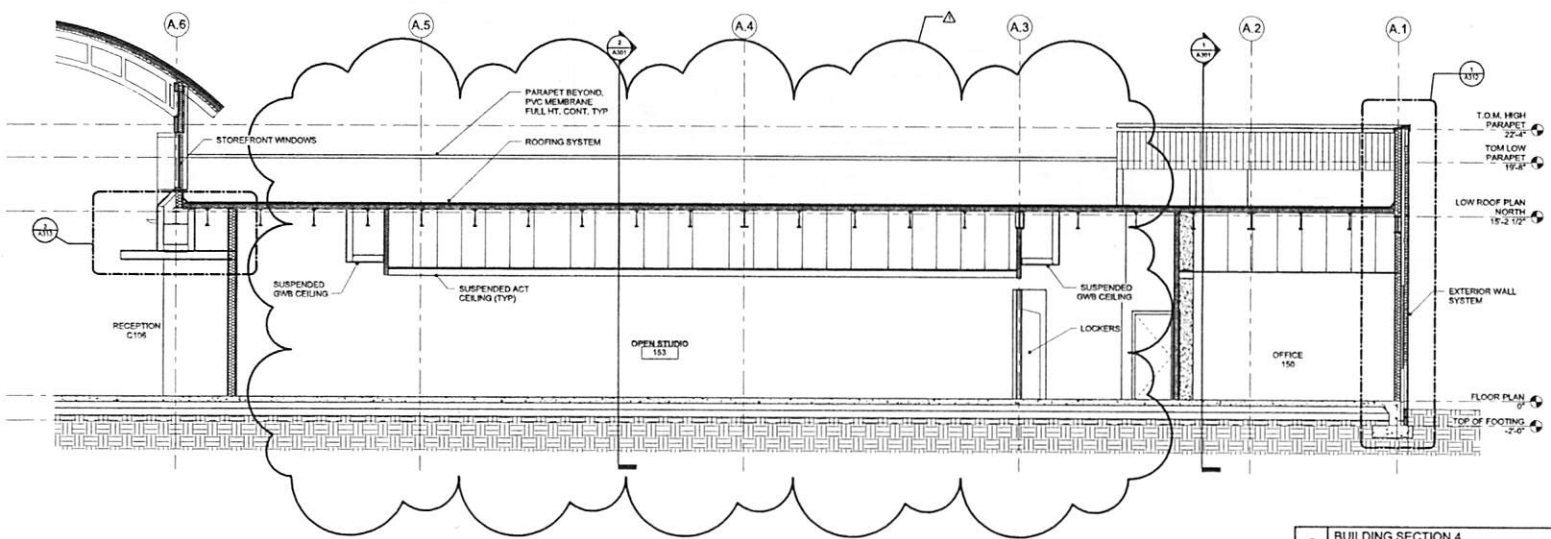

2 BUILDING SECTION 4 SCALE: 1/4" = 1'-0"

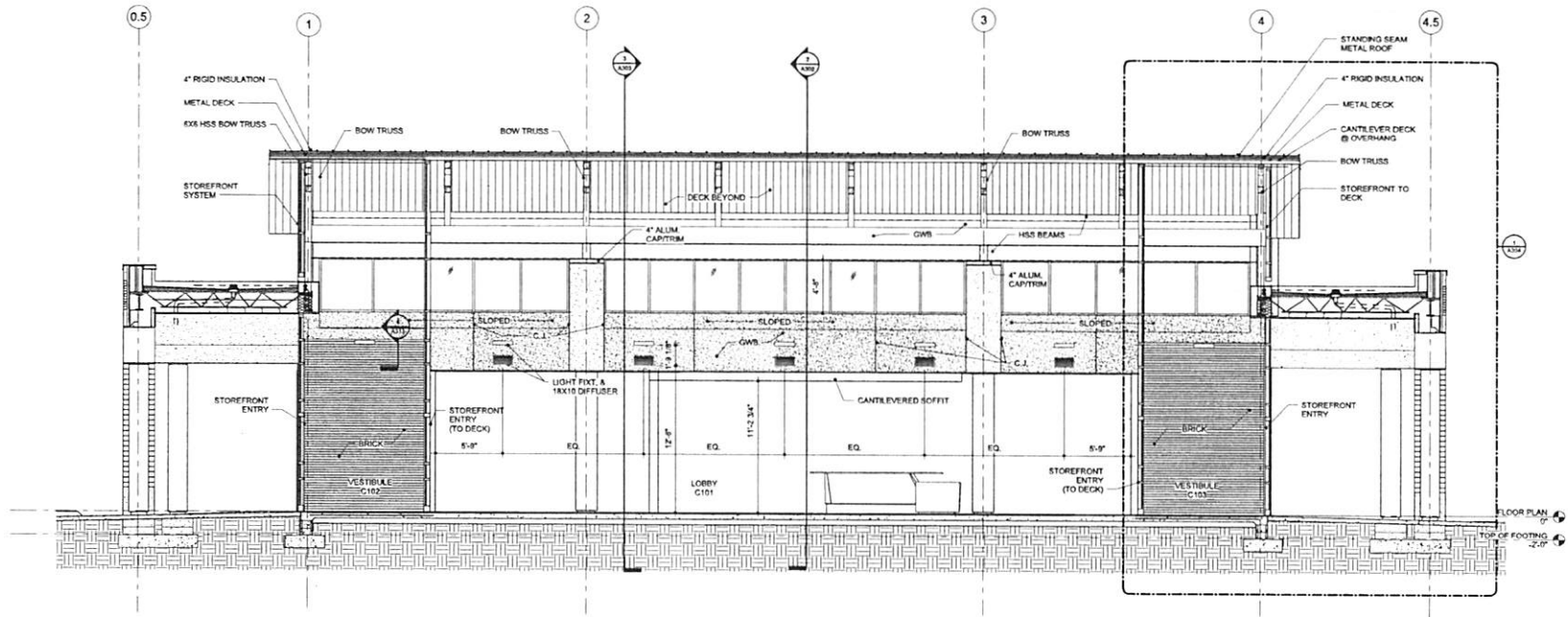

1 BUILDING SECTION 3 SCALE: 1/4" = 1'-0"

**WARD
SCOTT**
ARCHITECTURE

2715 Seventh Street
Tuscaloosa, AL 35401
www.ward-scott.com



THE EDGE BUSINESS RESOURCE CENTER
THE CITY OF TUSCALOOSA
2627 10TH AVENUE,
TUSCALOOSA, ALABAMA

CONSTRUCTION DOCUMENTS

DATE: 7-25-15
PROJ NO: 13-073

NO	DESC	DATE
1	ADDENDA	08/17
1		

BUILDING SECTIONS

A302

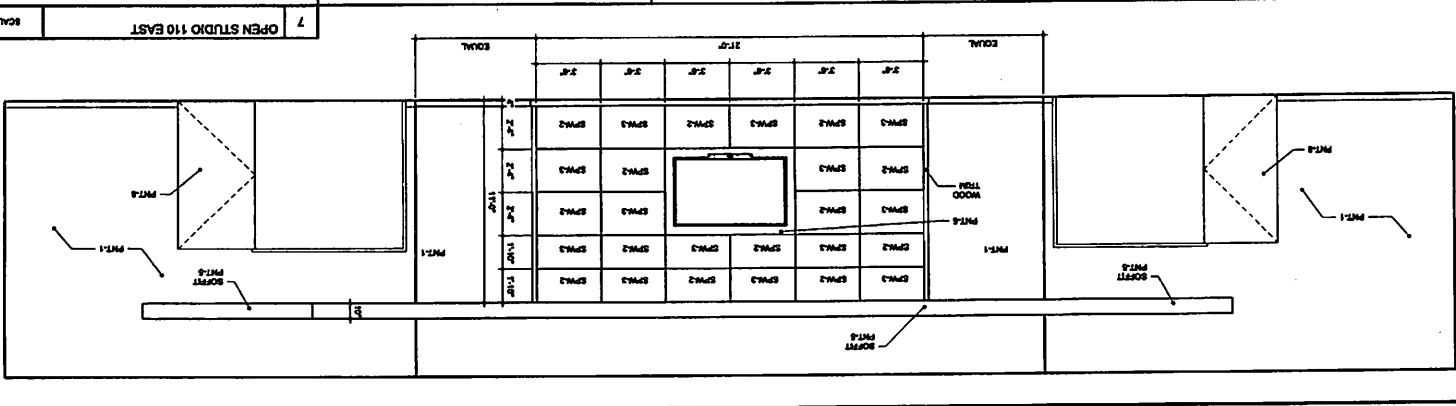
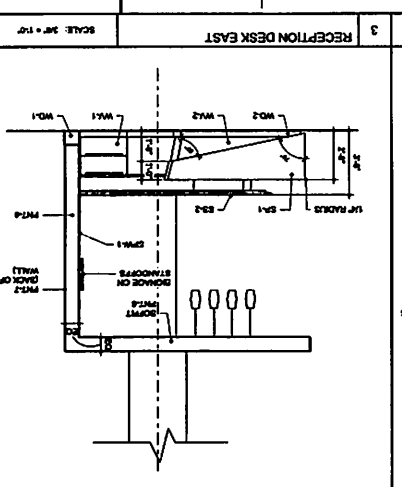
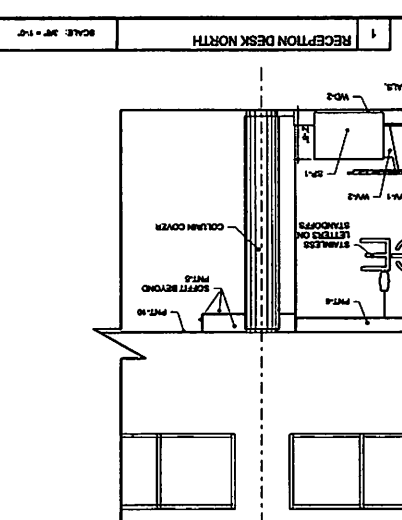
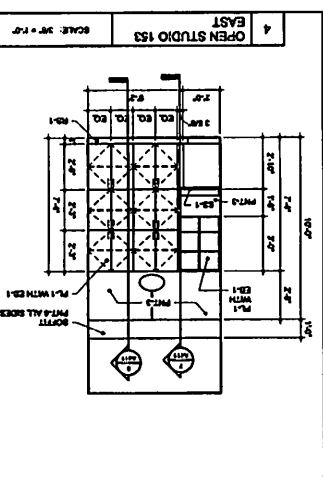
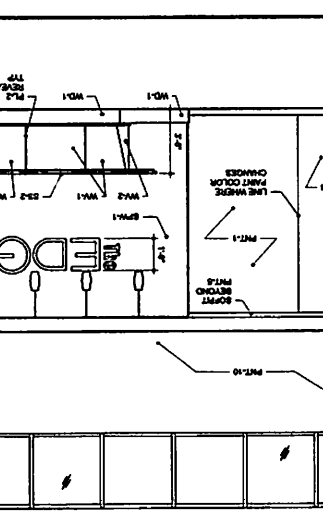
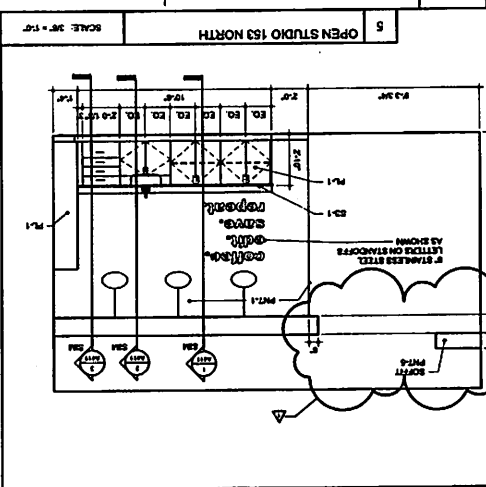
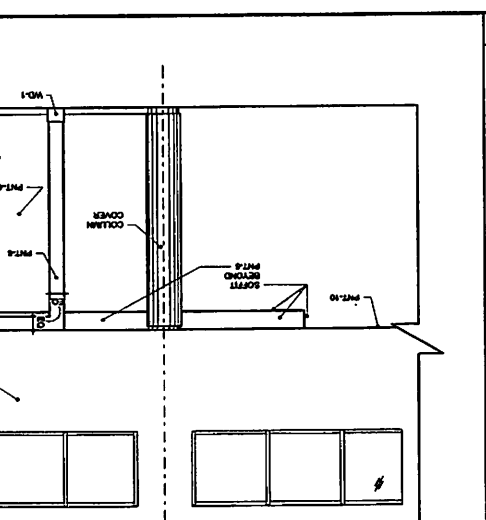
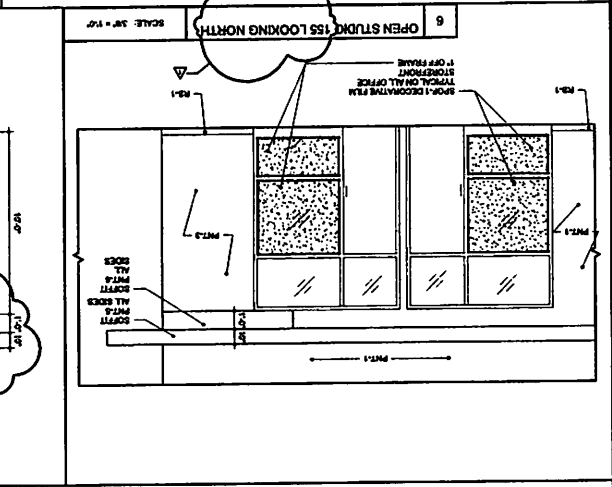
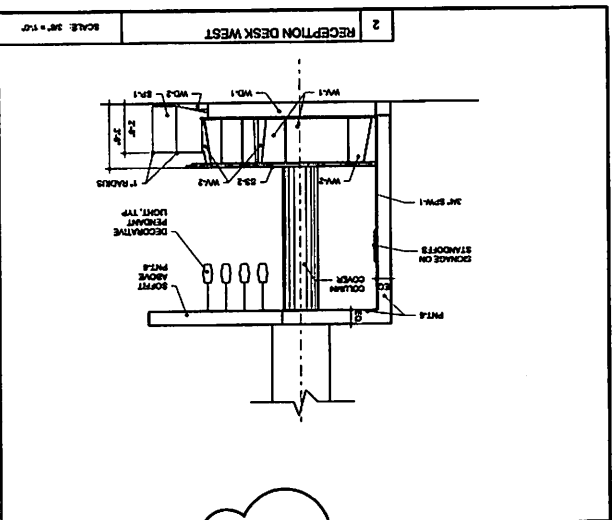

A401
 REVISION
 DATE
 DRAWN BY
 CHECKED BY
 DATE: 12-15-10
 PROJECT NO.: 14275
 CONSTRUCTION DOCUMENTS
 THE EDGE BUSINESS RESOURCE CENTER
 THE CITY OF TUSCALOOSA
 2827 10TH AVENUE
 TUSCALOOSA, ALABAMA

WARD SCOTT ARCHITECTS, INC.

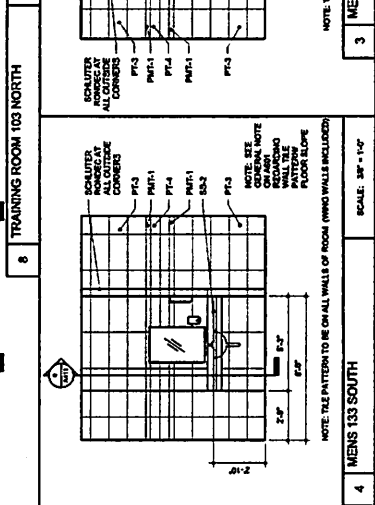
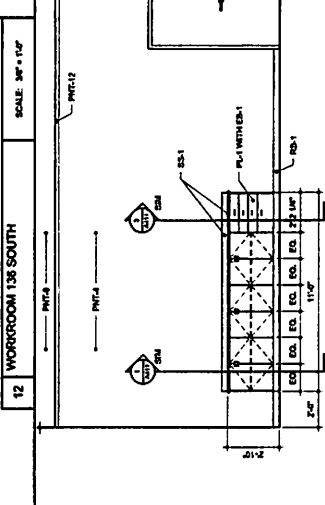
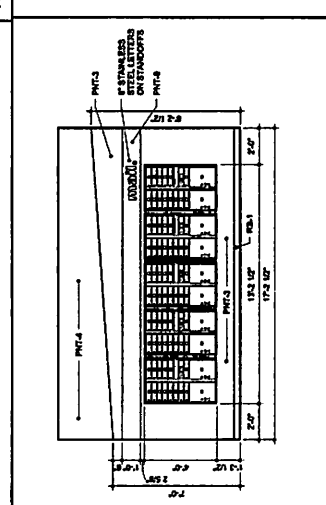
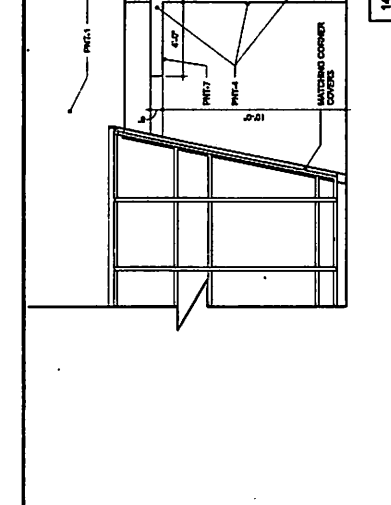
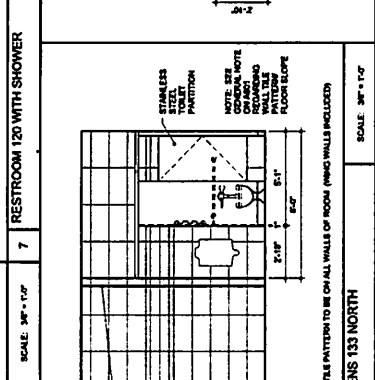
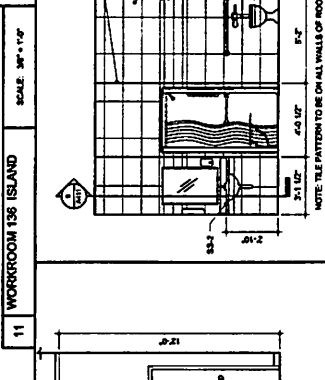
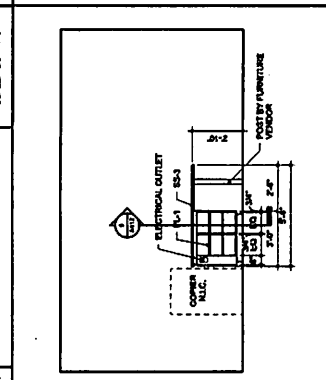
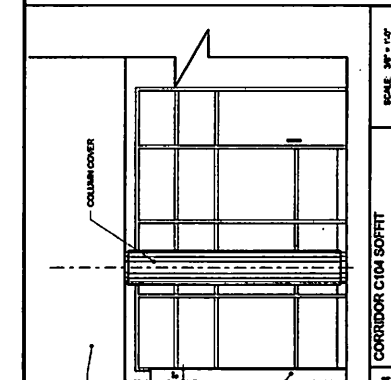
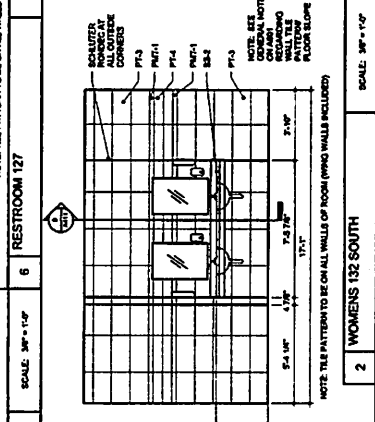
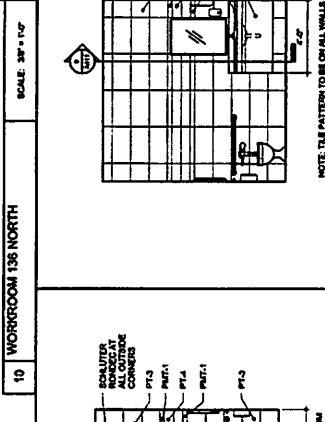
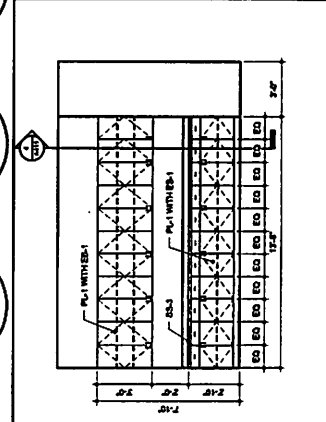
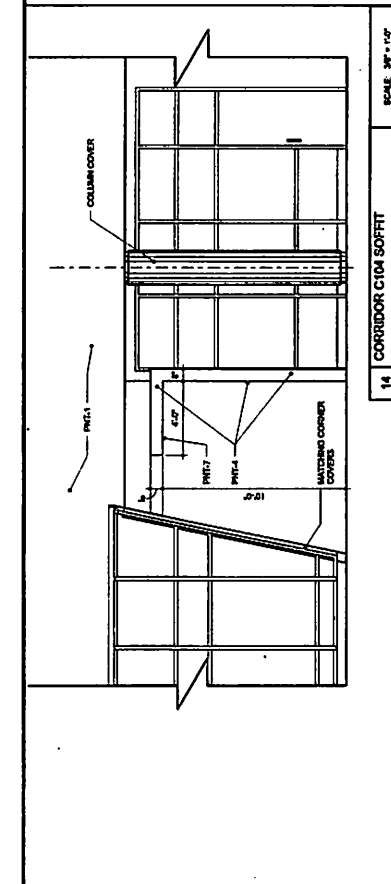
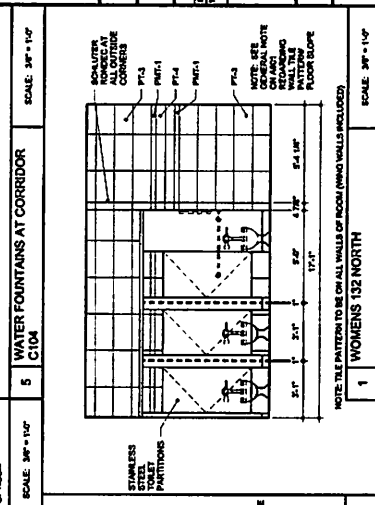
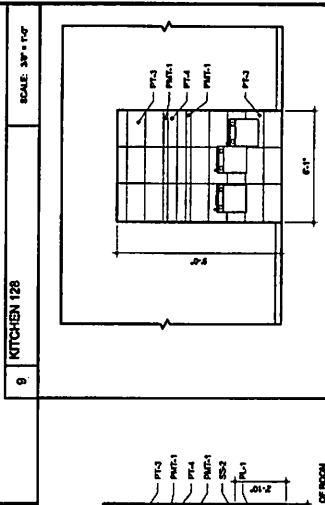
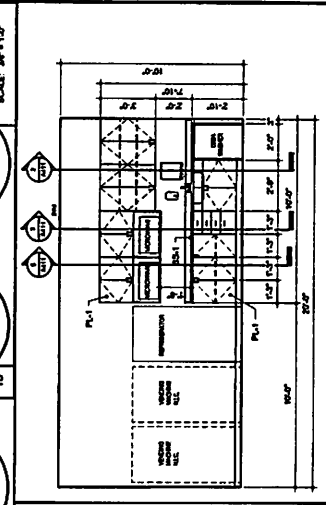
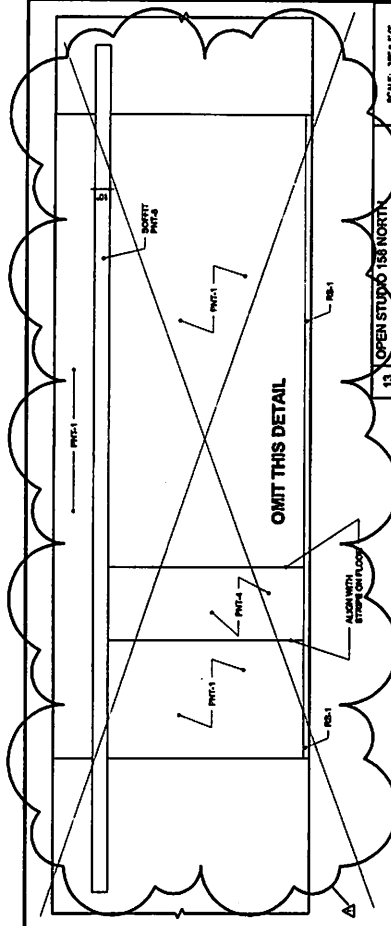

DATE: 02/08/16	PROJECT NO.: 14-073	CONSTRUCTION DOCUMENTS
DESIGN DATE: 02/08/16	ADDRESS: 2627	REVISIONS
PROJECT NAME: FIRST FLOOR PATTERN	PROJECT NO.: 14-073	DATE: 02/08/16
PROJECT NO.: 14-073	PROJECT NAME: FIRST FLOOR PATTERN	PROJECT NO.: 14-073

THE EDGE BUSINESS RESOURCE CENTER
 THE CITY OF TUSCALOOSA
 2627 10TH AVENUE
 TUSCALOOSA, ALABAMA



2715 Seventh Street
 Tuscaloosa, AL 35401
 www.ward-scott.com

WARD SCOTT ARCHITECTURE

- CARPET LEGEND**
- CPT-1, LAY ASHLAR
 - CPT-2, LAY HERRINGBONE
 - CPT-3, LAY ASHLAR
 - CPT-4, LAY ASHLAR
 - CPT-5, LAY ASHLAR
 - CPT-6, LAY QUARTERTURN
 - CPT-7, LAY ASHLAR

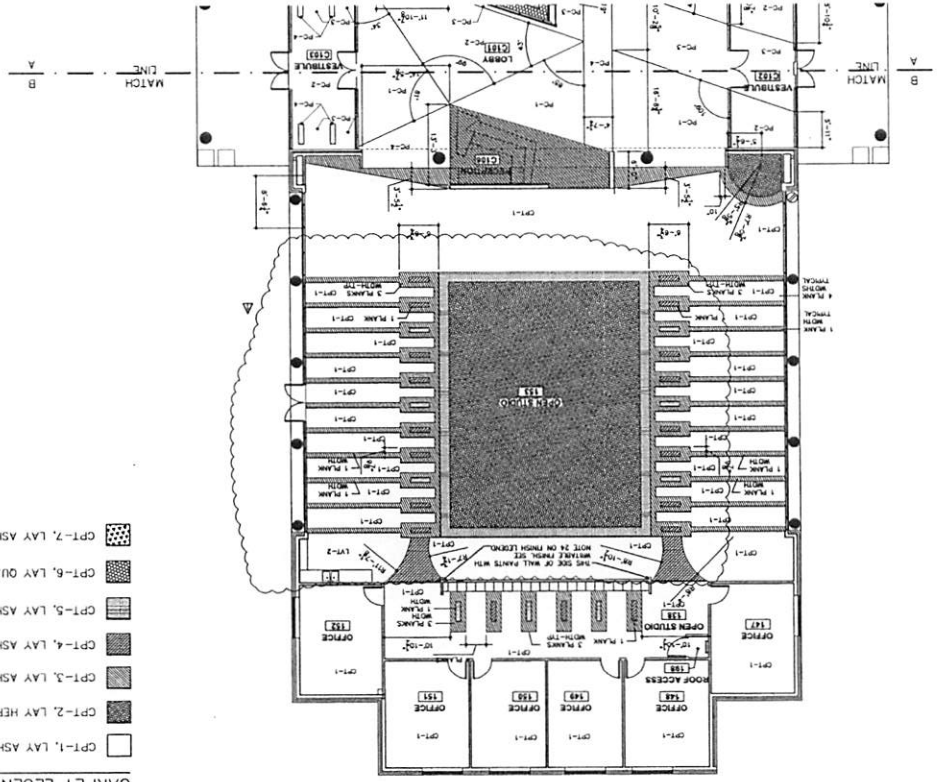

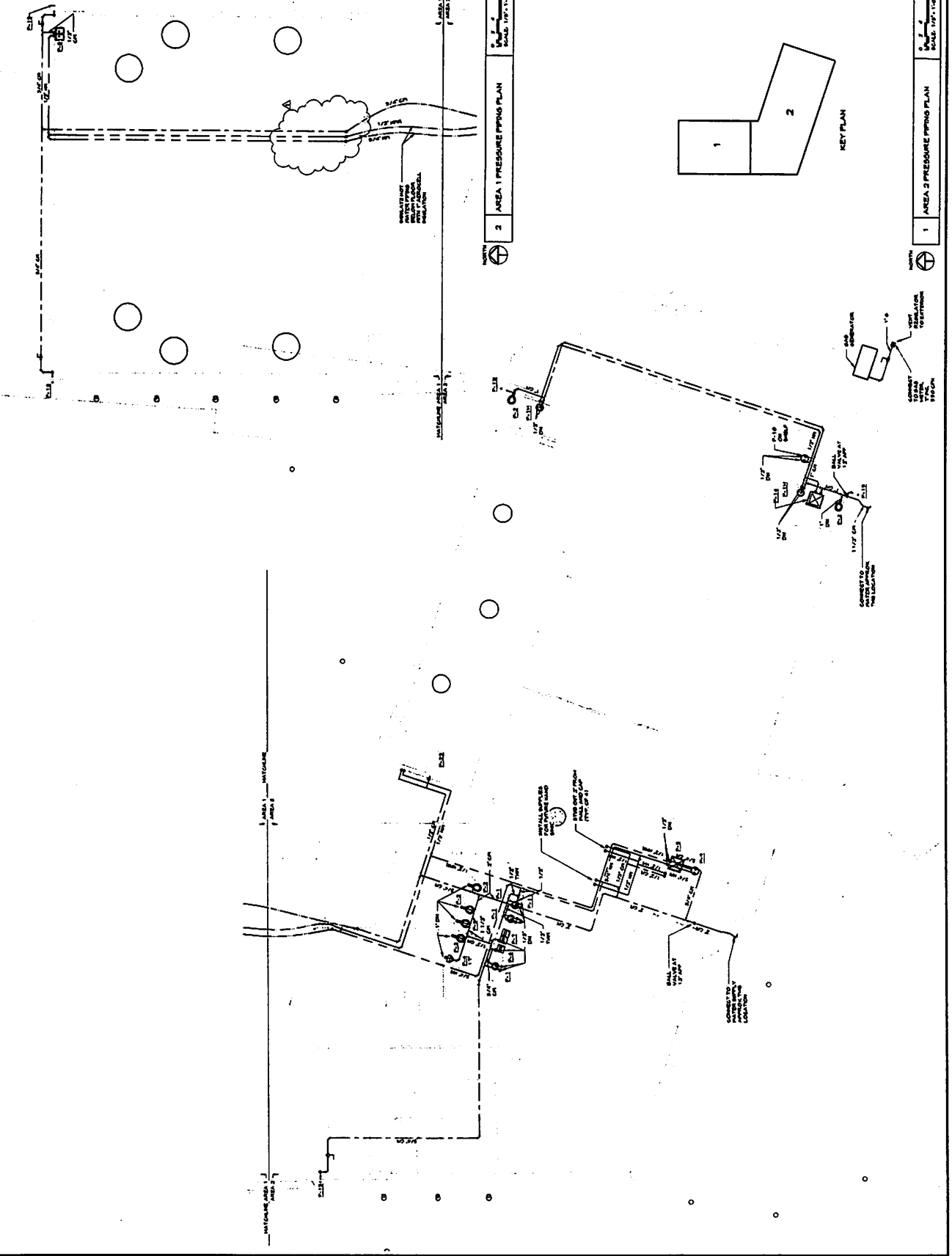



**WARD
SCOTT**
ARCHITECTURE

1713 Exchange Rd
Tuscaloosa, AL 35401
205.335.1100



RH Smith
3 months p.e.
Mechanical
Electrical
Plumbing
HVAC

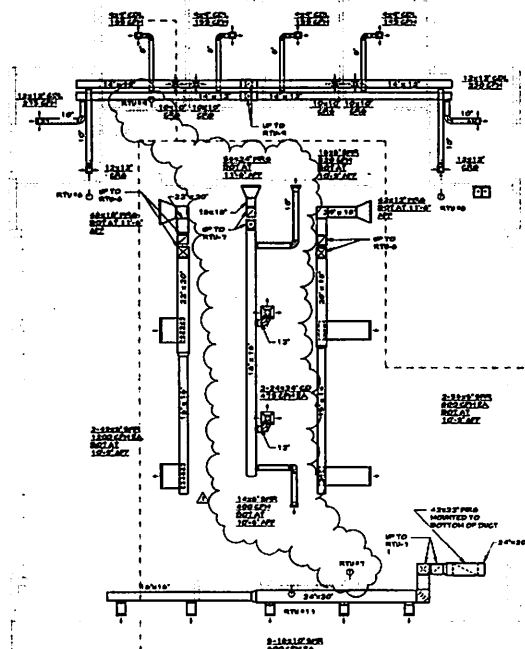

2 AREA 2 HVAC PLAN
SCALE: 1/8" = 1'-0"

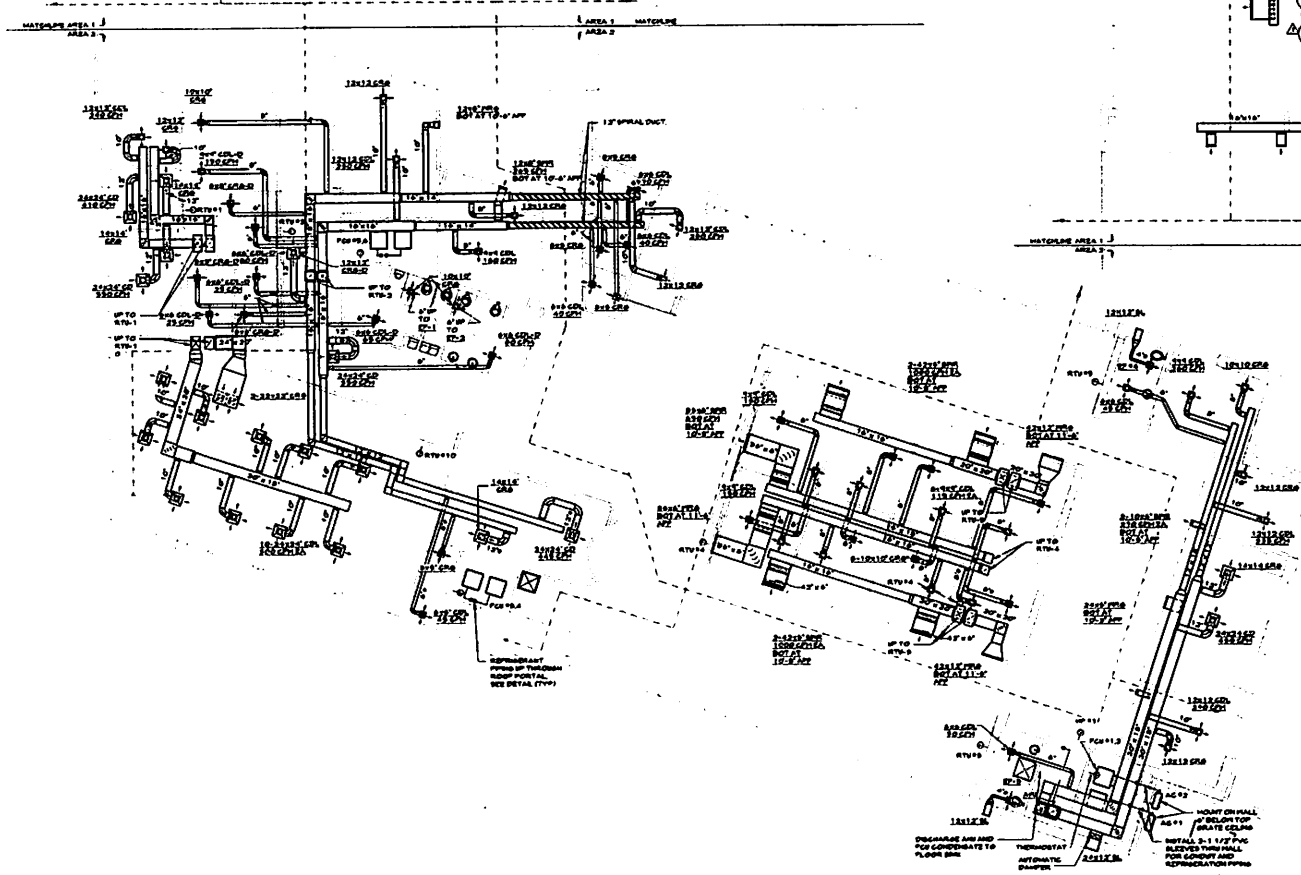

1 AREA 1 HVAC PLAN
SCALE: 1/8" = 1'-0"

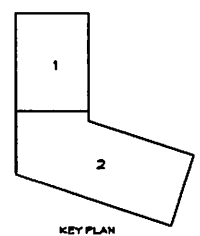

KEY PLAN

THE EDGE BUSINESS RESOURCE CENTER
THE CITY OF TUSCALOOSA
2627 10TH AVENUE, TUSCALOOSA, ALABAMA

THE EDGE BUSINESS RESOURCE CENTER

DATE: 07/20/15
PROJ NO.:

REVISIONS
DESC DATE
1 (None) 08-18-17

CONSTRUCTION DOCUMENTS

HVAC PLAN

M101

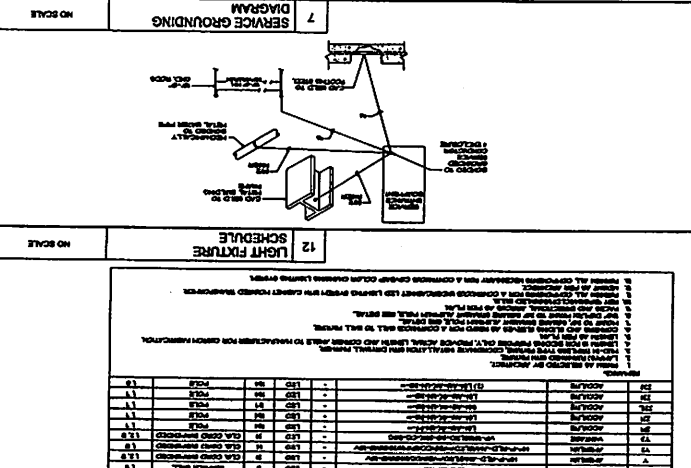
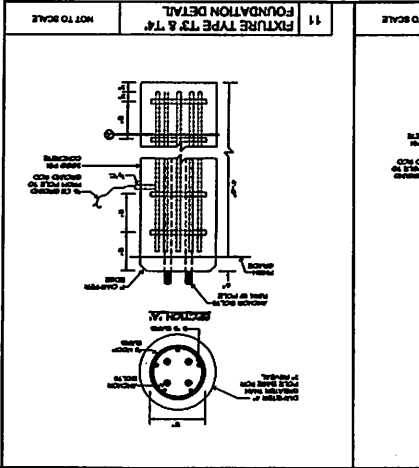
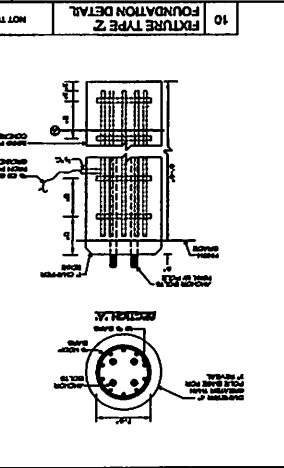
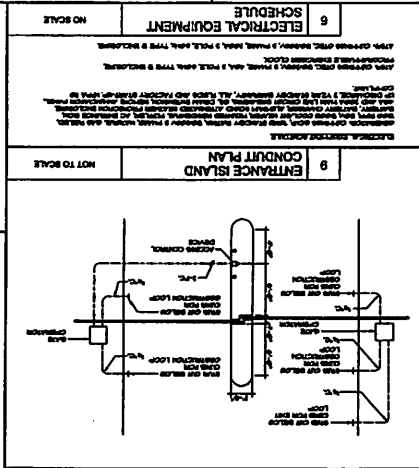
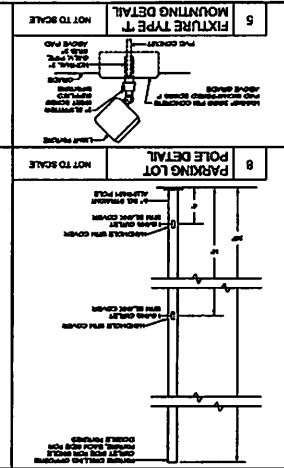
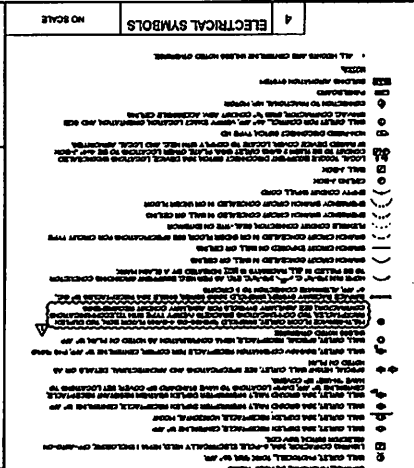
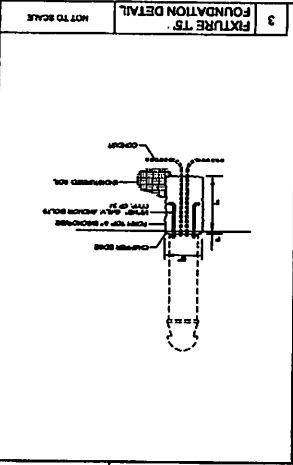
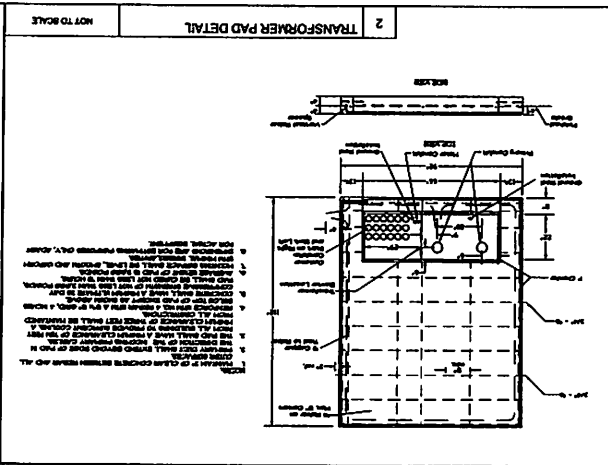
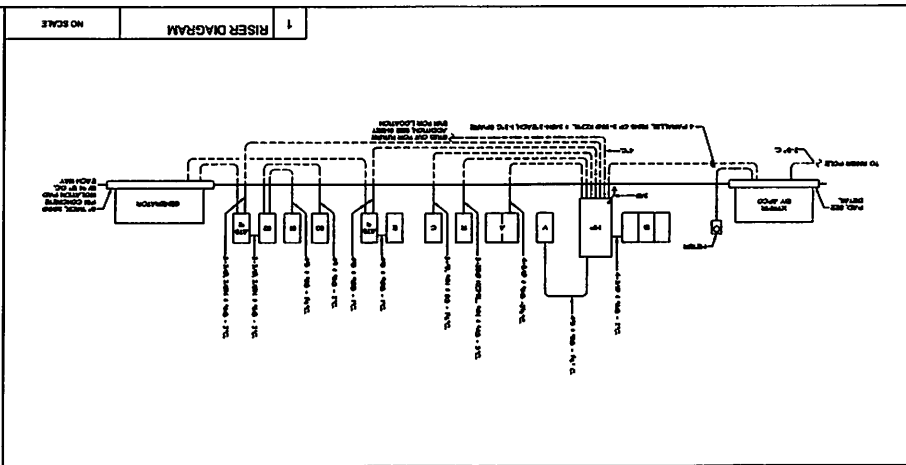

12 LIGHT FIXTURE SCHEDULE
NO SCALE

NO.	DESCRIPTION	TYPE	AMPERES	VOLTS	PHASES	WIRE TYPE	WIRE SIZE	CONDUIT	TERMINALS
1	Panel	PAN	1000	480	3	THHN	4/0	2"	4
2	Panel	PAN	1000	480	3	THHN	4/0	2"	4
3	Panel	PAN	1000	480	3	THHN	4/0	2"	4
4	Panel	PAN	1000	480	3	THHN	4/0	2"	4
5	Panel	PAN	1000	480	3	THHN	4/0	2"	4
6	Panel	PAN	1000	480	3	THHN	4/0	2"	4
7	Panel	PAN	1000	480	3	THHN	4/0	2"	4
8	Panel	PAN	1000	480	3	THHN	4/0	2"	4
9	Panel	PAN	1000	480	3	THHN	4/0	2"	4
10	Panel	PAN	1000	480	3	THHN	4/0	2"	4
11	Panel	PAN	1000	480	3	THHN	4/0	2"	4
12	Panel	PAN	1000	480	3	THHN	4/0	2"	4

E001

CONSTRUCTION DOCUMENTS
DATE: 7/20/15
PROJECT: 1411416

REVISIONS
DATE: 11/11/15

THE EDGE BUSINESS RESOURCE CENTER
THE CITY OF TUSCALOOSA
2627 10TH AVENUE, TUSCALOOSA, ALABAMA

WARD SCOTT ARCHITECTURE

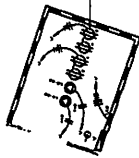
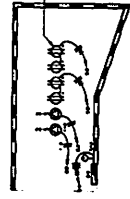

4	City Work LT. 122	SCALE: 1/4" = 1'-0"
3	AVY 105	SCALE: 1/4" = 1'-0"

THE EDGE BUSINESS RESOURCE CENTER
 THE CITY OF TUSCALOOSA
 2627 10TH AVENUE, TUSCALOOSA, ALABAMA



WARD SCOTT ARCHITECTURE
 ARCHITECTS
 1000 W. UNIVERSITY BLVD., SUITE 100
 TUSCALOOSA, AL 35403
 TEL: 205.344.1111 FAX: 205.344.1112
 WWW.WARDSCOTTARCHITECTS.COM



AS TO DESIGN
 CONSULTANTS:
 ELECTRICAL ENGINEERING
 MECHANICAL ENGINEERING
 PLUMBING ENGINEERING
 STRUCTURAL ENGINEERING
 CIVIL ENGINEERING
 LANDSCAPE ARCHITECTURE
 INTERIOR ARCHITECTURE
 HISTORIC PRESERVATION

- 1. SEE FIELD SURVEY FOR ALL DIMENSIONS AND LOCATIONS.
- 2. ALL DIMENSIONS ARE TO FACE UNLESS OTHERWISE NOTED.
- 3. DIMENSIONS TO FACE UNLESS OTHERWISE NOTED.
- 4. DIMENSIONS TO CENTERLINE UNLESS OTHERWISE NOTED.
- 5. DIMENSIONS TO CENTERLINE UNLESS OTHERWISE NOTED.
- 6. DIMENSIONS TO CENTERLINE UNLESS OTHERWISE NOTED.
- 7. DIMENSIONS TO CENTERLINE UNLESS OTHERWISE NOTED.
- 8. DIMENSIONS TO CENTERLINE UNLESS OTHERWISE NOTED.
- 9. DIMENSIONS TO CENTERLINE UNLESS OTHERWISE NOTED.
- 10. DIMENSIONS TO CENTERLINE UNLESS OTHERWISE NOTED.

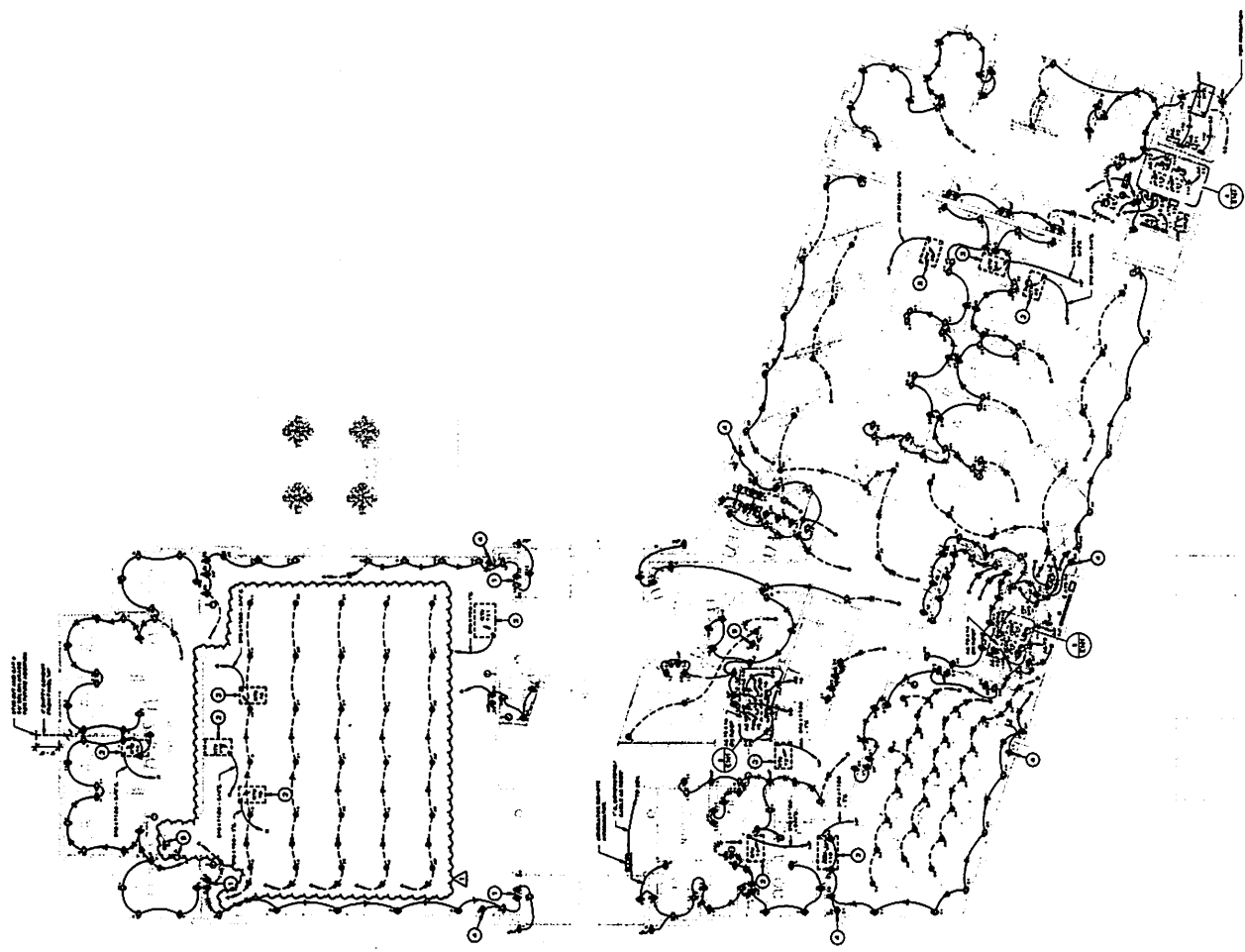

DATE:	7/26/11
PROJ. NO.:	11-072
REVISIONS:	
NO.:	
DATE:	
BY:	
CHKD. BY:	
DATE:	

CONSTRUCTION
OCCUPANCY

THE EDGE BUSINESS RESOURCE CENTER
THE CITY OF TUSCALOOSA
2627 10TH AVENUE, TUSCALOOSA, ALABAMA



WARD SCOTT ARCHITECTURE
1000 UNIVERSITY BLVD, SUITE 200
TUSCALOOSA, AL 35601
TEL: 205-756-1100
WWW.WARDSCOTTARCHITECTURE.COM

SCALE: 3/32" = 1'-0"

1 Lighting Plan

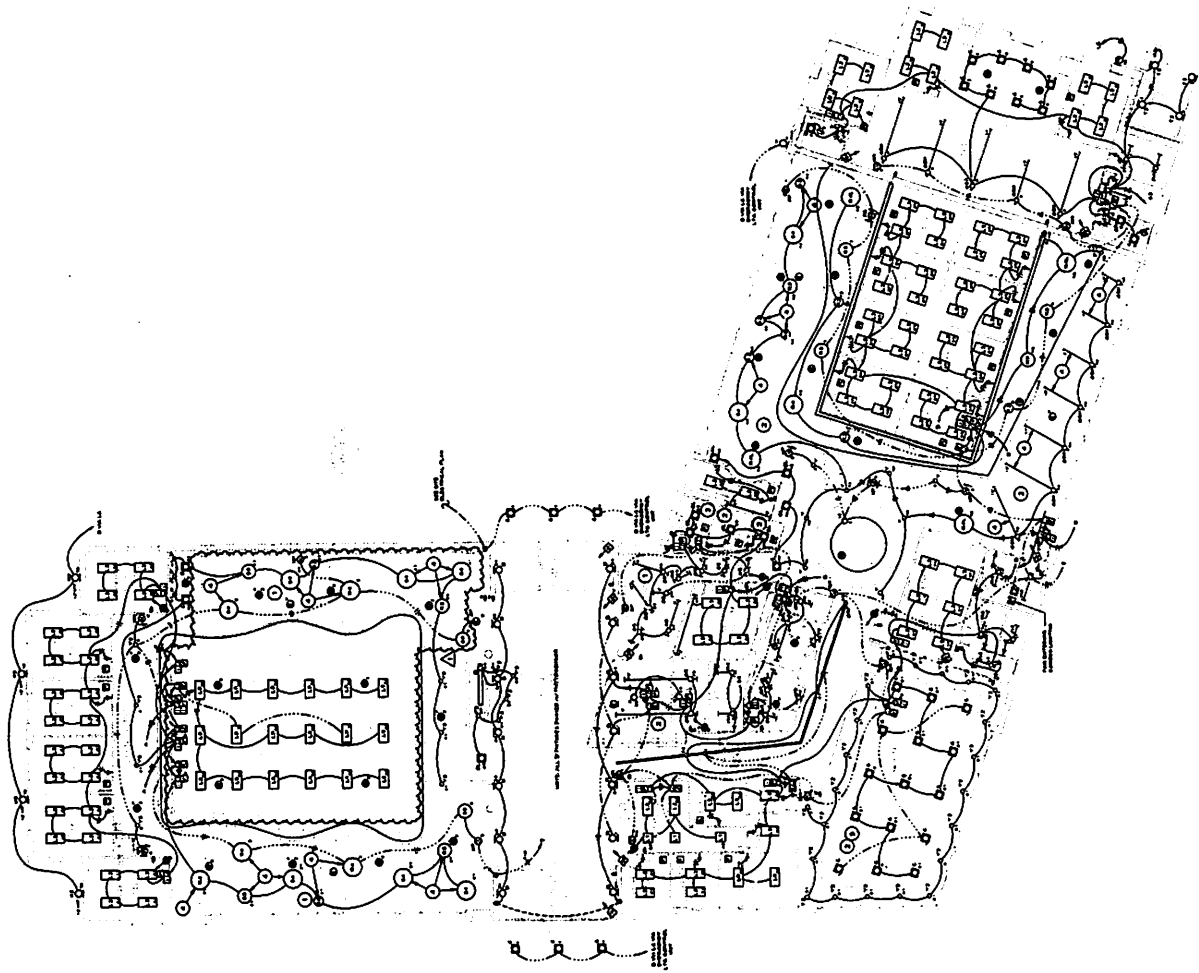

- WALKING LIGHTING NOTES**
- 1. REFER TO ALL PROJECTS & APPROVED DOCUMENTATION
 - 2. ALL LIGHTING FIXTURES SHALL BE INSTALLED TO MEET THE ILLUMINANCE REQUIREMENTS OF THE IESNA HANDBOOK
 - 3. ALL LIGHTING FIXTURES SHALL BE INSTALLED TO MEET THE IESNA HANDBOOK REQUIREMENTS FOR LIGHTING QUALITY
 - 4. ALL LIGHTING FIXTURES SHALL BE INSTALLED TO MEET THE IESNA HANDBOOK REQUIREMENTS FOR LIGHTING QUALITY





AUXILIARY PLAN

REVISIONS

DATE

BY

DATE

BY

DATE

BY

DATE

BY

DATE

BY

DATE

BY

DATE

BY

DATE

BY

DATE

BY

DATE

BY

DATE

BY

DATE

BY

DATE

BY

DATE

BY

DATE

BY

DATE

BY

DATE

BY

DATE

BY

DATE

BY

DATE

BY

DATE

BY

DATE

BY

DATE

BY

DATE

BY

DATE

BY

DATE

BY

DATE

BY

DATE

BY

DATE

BY

DATE

BY

DATE

BY

DATE

BY

DATE

BY

DATE

BY

DATE

BY

DATE

BY

DATE

BY

DATE

BY

DATE

BY

DATE

BY

DATE

BY

THE EDGE BUSINESS RESOURCE CENTER
THE CITY OF TUSCALOOSA
2627 10TH AVENUE, TUSCALOOSA, ALABAMA

WARD SCOTT ARCHITECTURE
2627 10th Avenue, Tuscaloosa, AL 35401
Phone: 205.335.1111
www.wardscott.com

Ward Scott
Professional Engineer
State of Alabama
License No. 11111
Expiration Date 12/31/2018

- SPECIAL NOTE:**
1. ALL DIMENSIONS ARE TO FACE UNLESS OTHERWISE NOTED.
 2. ALL DIMENSIONS ARE TO FACE UNLESS OTHERWISE NOTED.
 3. ALL DIMENSIONS ARE TO FACE UNLESS OTHERWISE NOTED.
 4. ALL DIMENSIONS ARE TO FACE UNLESS OTHERWISE NOTED.
 5. ALL DIMENSIONS ARE TO FACE UNLESS OTHERWISE NOTED.
 6. ALL DIMENSIONS ARE TO FACE UNLESS OTHERWISE NOTED.
 7. ALL DIMENSIONS ARE TO FACE UNLESS OTHERWISE NOTED.
 8. ALL DIMENSIONS ARE TO FACE UNLESS OTHERWISE NOTED.
 9. ALL DIMENSIONS ARE TO FACE UNLESS OTHERWISE NOTED.

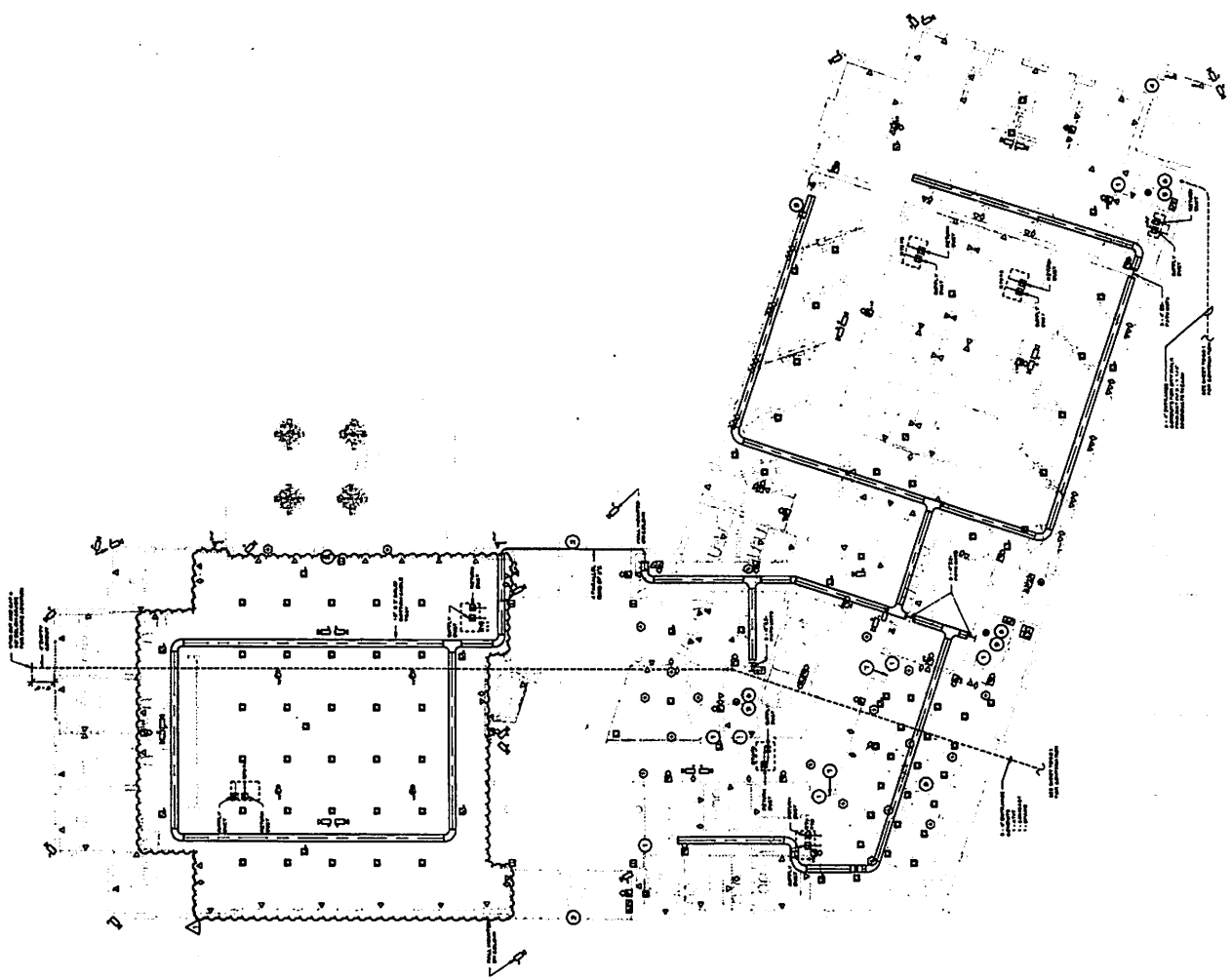

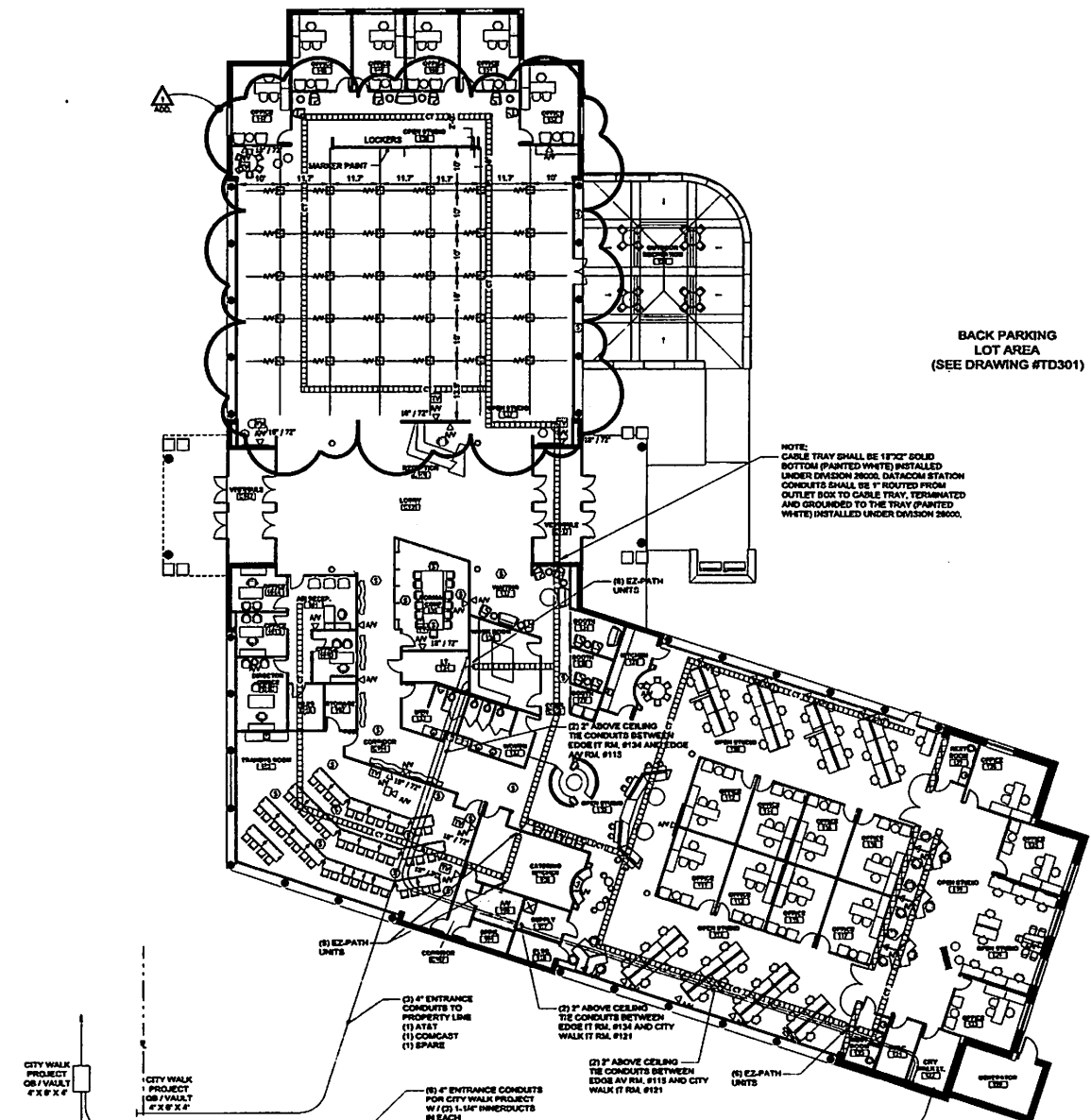

BACK PARKING
LOT AREA
(SEE DRAWING #TD301)

NOTE:
CABLE TRAY SHALL BE 18"X2" SOLID
BOTTOM (PAINTED WHITE) INSTALLED
UNDER DIVISION 2800. DATACOM STATION
CONDUITS SHALL BE 1" ROUTED FROM
OUTLET BOX TO CABLE TRAY, TERMINATED
AND GROUNDED TO THE TRAY (PAINTED
WHITE) INSTALLED UNDER DIVISION 2800.

- CONTRACTOR NOTE**
1. THE CONTRACTOR SHALL INSTALL ALL DATA 6.0 AMP WIRELESS ACCESS POINTS PER IT WORK PACKAGE BY IT WORKERS.
 2. THE CONTRACTOR SHALL INSTALL ALL 4V, CAMERA, AV/VIDEO CONTROLS/CABLE RELAYS OR OTHER DEVICES PER IT WORKERS AND WIRING BY IT WORKERS TO 6.0 AMP RIM.
- CONTRACTOR NOTE**
1. THE CONTRACTOR SHALL PROVIDE ALL APPROVED RACKS OR STATION CABINETS AT ALL FLOOR LEVELS UNLESS OTHERWISE NOTED ON DRAWINGS. THE CONTRACTOR SHALL BE RESPONSIBLE FOR COORDINATING AND PROVIDING THE REQUIRED AMOUNT OF RACKS AT ALL LEVELS WITH THE OWNER REPRESENTATIVE. THE CONTRACTOR SHALL BE RESPONSIBLE FOR THE NOTIFY THE STATION CABINET THROUGH THE INVOICER PERFORMANCE AT ALL LOCATIONS.
 2. THE CONTRACTOR SHALL INSTALL 600 TYPE CABLE OR EQUIPMENT, AND SHALL PROVIDE, THESE TYPES OF INSTALLATIONS ARE COMBINED WITH EQUIPMENT LOCATIONS.
 3. THE CONTRACTOR SHALL INSTALL ALL TELEPHONE POINTS TO CHANGE FROM PLUMBING CABLE TYPE TO OSP CABLE TYPE AT ALL LOCATIONS AS REQUIRED.
 4. THE CONTRACTOR SHALL INSTALL 600 TYPE CABLE AT ALL PARKING LOT FIELDS. THE TYPE OF INSTALLATION ARE COMBINED WITH EQUIPMENT LOCATIONS.

LEGENDS/SYMBOLS

(S)	SPRINKLER
(R)	CARD READER
(E)	WIRE MESH/CLAMP SYSTEM
(M)	4V WIRE DISTRIBUTION
(T)	TELEPHONE
(C)	CONDUIT
(D)	DATA
(V)	VIDEO
(A)	AV
(S)	SPRINKLER
(R)	RECORDING
(E)	ELECTRICAL
(M)	MEDIA
(T)	TELEPHONE
(C)	CONDUIT
(D)	DATA
(V)	VIDEO
(A)	AV
(S)	SPRINKLER
(R)	RECORDING
(E)	ELECTRICAL
(M)	MEDIA
(T)	TELEPHONE
(C)	CONDUIT
(D)	DATA
(V)	VIDEO
(A)	AV
(S)	SPRINKLER
(R)	RECORDING
(E)	ELECTRICAL
(M)	MEDIA
(T)	TELEPHONE
(C)	CONDUIT
(D)	DATA
(V)	VIDEO
(A)	AV
(S)	SPRINKLER
(R)	RECORDING
(E)	ELECTRICAL
(M)	MEDIA
(T)	TELEPHONE
(C)	CONDUIT
(D)	DATA
(V)	VIDEO
(A)	AV
(S)	SPRINKLER
(R)	RECORDING
(E)	ELECTRICAL
(M)	MEDIA
(T)	TELEPHONE
(C)	CONDUIT
(D)	DATA
(V)	VIDEO
(A)	AV
(S)	SPRINKLER
(R)	RECORDING
(E)	ELECTRICAL
(M)	MEDIA
(T)	TELEPHONE
(C)	CONDUIT
(D)	DATA
(V)	VIDEO
(A)	AV
(S)	SPRINKLER
(R)	RECORDING
(E)	ELECTRICAL
(M)	MEDIA
(T)	TELEPHONE
(C)	CONDUIT
(D)	DATA
(V)	VIDEO
(A)	AV
(S)	SPRINKLER
(R)	RECORDING
(E)	ELECTRICAL
(M)	MEDIA
(T)	TELEPHONE
(C)	CONDUIT
(D)	DATA
(V)	VIDEO
(A)	AV
(S)	SPRINKLER
(R)	RECORDING
(E)	ELECTRICAL
(M)	MEDIA
(T)	TELEPHONE
(C)	CONDUIT
(D)	DATA
(V)	VIDEO
(A)	AV
(S)	SPRINKLER
(R)	RECORDING
(E)	ELECTRICAL
(M)	MEDIA
(T)	TELEPHONE
(C)	CONDUIT
(D)	DATA
(V)	VIDEO
(A)	AV
(S)	SPRINKLER
(R)	RECORDING
(E)	ELECTRICAL
(M)	MEDIA
(T)	TELEPHONE
(C)	CONDUIT
(D)	DATA
(V)	VIDEO
(A)	AV
(S)	SPRINKLER
(R)	RECORDING
(E)	ELECTRICAL
(M)	MEDIA
(T)	TELEPHONE
(C)	CONDUIT
(D)	DATA
(V)	VIDEO
(A)	AV
(S)	SPRINKLER
(R)	RECORDING
(E)	ELECTRICAL
(M)	MEDIA
(T)	TELEPHONE
(C)	CONDUIT
(D)	DATA
(V)	VIDEO
(A)	AV
(S)	SPRINKLER
(R)	RECORDING
(E)	ELECTRICAL
(M)	MEDIA
(T)	TELEPHONE
(C)	CONDUIT
(D)	DATA
(V)	VIDEO
(A)	AV
(S)	SPRINKLER
(R)	RECORDING
(E)	ELECTRICAL
(M)	MEDIA
(T)	TELEPHONE
(C)	CONDUIT
(D)	DATA
(V)	VIDEO
(A)	AV
(S)	SPRINKLER
(R)	RECORDING
(E)	ELECTRICAL
(M)	MEDIA
(T)	TELEPHONE
(C)	CONDUIT
(D)	DATA
(V)	VIDEO
(A)	AV
(S)	SPRINKLER
(R)	RECORDING
(E)	ELECTRICAL
(M)	MEDIA
(T)	TELEPHONE
(C)	CONDUIT
(D)	DATA
(V)	VIDEO
(A)	AV
(S)	SPRINKLER
(R)	RECORDING
(E)	ELECTRICAL
(M)	MEDIA
(T)	TELEPHONE
(C)	CONDUIT
(D)	DATA
(V)	VIDEO
(A)	AV
(S)	SPRINKLER
(R)	RECORDING
(E)	ELECTRICAL
(M)	MEDIA
(T)	TELEPHONE
(C)	CONDUIT
(D)	DATA
(V)	VIDEO
(A)	AV
(S)	SPRINKLER
(R)	RECORDING
(E)	ELECTRICAL
(M)	MEDIA
(T)	TELEPHONE
(C)	CONDUIT
(D)	DATA
(V)	VIDEO
(A)	AV
(S)	SPRINKLER
(R)	RECORDING
(E)	ELECTRICAL
(M)	MEDIA
(T)	TELEPHONE
(C)	CONDUIT
(D)	DATA
(V)	VIDEO
(A)	AV
(S)	SPRINKLER
(R)	RECORDING
(E)	ELECTRICAL
(M)	MEDIA
(T)	TELEPHONE
(C)	CONDUIT
(D)	DATA
(V)	VIDEO
(A)	AV
(S)	SPRINKLER
(R)	RECORDING
(E)	ELECTRICAL
(M)	MEDIA
(T)	TELEPHONE
(C)	CONDUIT
(D)	DATA
(V)	VIDEO
(A)	AV
(S)	SPRINKLER
(R)	RECORDING
(E)	ELECTRICAL
(M)	MEDIA
(T)	TELEPHONE
(C)	CONDUIT
(D)	DATA
(V)	VIDEO
(A)	AV
(S)	SPRINKLER
(R)	RECORDING
(E)	ELECTRICAL
(M)	MEDIA
(T)	TELEPHONE
(C)	CONDUIT
(D)	DATA
(V)	VIDEO
(A)	AV
(S)	SPRINKLER
(R)	RECORDING
(E)	ELECTRICAL
(M)	MEDIA
(T)	TELEPHONE
(C)	CONDUIT
(D)	DATA
(V)	VIDEO
(A)	AV
(S)	SPRINKLER
(R)	RECORDING
(E)	ELECTRICAL
(M)	MEDIA
(T)	TELEPHONE
(C)	CONDUIT
(D)	DATA
(V)	VIDEO
(A)	AV
(S)	SPRINKLER
(R)	RECORDING
(E)	ELECTRICAL
(M)	MEDIA
(T)	TELEPHONE
(C)	CONDUIT
(D)	DATA
(V)	VIDEO
(A)	AV
(S)	SPRINKLER
(R)	RECORDING
(E)	ELECTRICAL
(M)	MEDIA
(T)	TELEPHONE
(C)	CONDUIT
(D)	DATA
(V)	VIDEO
(A)	AV
(S)	SPRINKLER
(R)	RECORDING
(E)	ELECTRICAL
(M)	MEDIA
(T)	TELEPHONE
(C)	CONDUIT
(D)	DATA
(V)	VIDEO
(A)	AV
(S)	SPRINKLER
(R)	RECORDING
(E)	ELECTRICAL
(M)	MEDIA
(T)	TELEPHONE
(C)	CONDUIT
(D)	DATA
(V)	VIDEO
(A)	AV
(S)	SPRINKLER
(R)	RECORDING
(E)	ELECTRICAL
(M)	MEDIA
(T)	TELEPHONE
(C)	CONDUIT
(D)	DATA
(V)	VIDEO
(A)	AV
(S)	SPRINKLER
(R)	RECORDING
(E)	ELECTRICAL
(M)	MEDIA
(T)	TELEPHONE
(C)	CONDUIT
(D)	DATA
(V)	VIDEO
(A)	AV
(S)	SPRINKLER
(R)	RECORDING
(E)	ELECTRICAL
(M)	MEDIA
(T)	TELEPHONE
(C)	CONDUIT
(D)	DATA
(V)	VIDEO
(A)	AV
(S)	SPRINKLER
(R)	RECORDING
(E)	ELECTRICAL
(M)	MEDIA
(T)	TELEPHONE
(C)	CONDUIT
(D)	DATA
(V)	VIDEO
(A)	AV
(S)	SPRINKLER
(R)	RECORDING
(E)	ELECTRICAL
(M)	MEDIA
(T)	TELEPHONE
(C)	CONDUIT
(D)	DATA
(V)	VIDEO
(A)	AV
(S)	SPRINKLER
(R)	RECORDING
(E)	ELECTRICAL
(M)	MEDIA
(T)	TELEPHONE
(C)	CONDUIT
(D)	DATA
(V)	VIDEO
(A)	AV
(S)	SPRINKLER
(R)	RECORDING
(E)	ELECTRICAL
(M)	MEDIA
(T)	TELEPHONE
(C)	CONDUIT
(D)	DATA
(V)	VIDEO
(A)	AV
(S)	SPRINKLER
(R)	RECORDING
(E)	ELECTRICAL
(M)	MEDIA
(T)	TELEPHONE
(C)	CONDUIT
(D)	DATA
(V)	VIDEO
(A)	AV
(S)	SPRINKLER
(R)	RECORDING
(E)	ELECTRICAL
(M)	MEDIA
(T)	TELEPHONE
(C)	CONDUIT
(D)	DATA
(V)	VIDEO
(A)	AV
(S)	SPRINKLER
(R)	RECORDING
(E)	ELECTRICAL
(M)	MEDIA
(T)	TELEPHONE
(C)	CONDUIT
(D)	DATA
(V)	VIDEO
(A)	AV
(S)	SPRINKLER
(R)	RECORDING
(E)	ELECTRICAL
(M)	MEDIA
(T)	TELEPHONE
(C)	CONDUIT
(D)	DATA
(V)	VIDEO
(A)	AV
(S)	SPRINKLER
(R)	RECORDING
(E)	ELECTRICAL
(M)	MEDIA
(T)	TELEPHONE
(C)	CONDUIT
(D)	DATA
(V)	VIDEO
(A)	AV
(S)	SPRINKLER
(R)	RECORDING
(E)	ELECTRICAL
(M)	MEDIA
(T)	TELEPHONE
(C)	CONDUIT
(D)	DATA
(V)	VIDEO
(A)	AV
(S)	SPRINKLER
(R)	RECORDING
(E)	ELECTRICAL
(M)	MEDIA
(T)	TELEPHONE
(C)	CONDUIT
(D)	DATA
(V)	VIDEO
(A)	AV
(S)	SPRINKLER
(R)	RECORDING
(E)	ELECTRICAL
(M)	MEDIA
(T)	TELEPHONE
(C)	CONDUIT
(D)	DATA
(V)	VIDEO
(A)	AV
(S)	SPRINKLER
(R)	RECORDING
(E)	ELECTRICAL
(M)	MEDIA
(T)	TELEPHONE
(C)	CONDUIT
(D)	DATA
(V)	VIDEO
(A)	AV
(S)	SPRINKLER
(R)	RECORDING
(E)	ELECTRICAL
(M)	MEDIA
(T)	TELEPHONE
(C)	CONDUIT
(D)	DATA
(V)	VIDEO
(A)	AV
(S)	SPRINKLER
(R)	RECORDING
(E)	ELECTRICAL
(M)	MEDIA
(T)	TELEPHONE
(C)	CONDUIT
(D)	DATA
(V)	VIDEO
(A)	AV
(S)	SPRINKLER
(R)	RECORDING
(E)	ELECTRICAL
(M)	MEDIA
(T)	TELEPHONE
(C)	CONDUIT
(D)	DATA
(V)	VIDEO
(A)	AV
(S)	SPRINKLER
(R)	RECORDING
(E)	ELECTRICAL
(M)	MEDIA
(T)	TELEPHONE
(C)	CONDUIT
(D)	DATA
(V)	VIDEO
(A)	AV
(S)	SPRINKLER
(R)	RECORDING
(E)	ELECTRICAL
(M)	MEDIA
(T)	TELEPHONE
(C)	CONDUIT
(D)	DATA
(V)	VIDEO
(A)	AV
(S)	SPRINKLER
(R)	RECORDING
(E)	ELECTRICAL
(M)	MEDIA
(T)	TELEPHONE
(C)	CONDUIT
(D)	DATA
(V)	VIDEO
(A)	AV
(S)	SPRINKLER
(R)	RECORDING
(E)	ELECTRICAL
(M)	MEDIA
(T)	TELEPHONE
(C)	CONDUIT
(D)	DATA
(V)	VIDEO
(A)	AV
(S)	SPRINKLER
(R)	RECORDING
(E)	ELECTRICAL
(M)	MEDIA
(T)	TELEPHONE
(C)	CONDUIT
(D)	DATA
(V)	VIDEO
(A)	AV
(S)	SPRINKLER
(R)	RECORDING
(E)	ELECTRICAL
(M)	MEDIA
(T)	TELEPHONE
(C)	CONDUIT
(D)	DATA
(V)	VIDEO
(A)	AV
(S)	SPRINKLER
(R)	RECORDING
(E)	ELECTRICAL
(M)	MEDIA
(T)	TELEPHONE
(C)	CONDUIT
(D)	DATA
(V)	VIDEO
(A)	AV
(S)	SPRINKLER
(R)	RECORDING
(E)	ELECTRICAL
(M)	MEDIA
(T)	TELEPHONE
(C)	CONDUIT
(D)	DATA
(V)	VIDEO
(A)	AV
(S)	SPRINKLER
(R)	RECORDING
(E)	ELECTRICAL
(M)	MEDIA
(T)	TELEPHONE
(C)	CONDUIT
(D)	DATA
(V)	VIDEO
(A)	AV
(S)	SPRINKLER
(R)	RECORDING
(E)	ELECTRICAL
(M)	MEDIA
(T)	TELEPHONE
(C)	CONDUIT
(D)	DATA
(V)	VIDEO
(A)	AV
(S)	SPRINKLER
(R)	RECORDING
(E)	ELECTRICAL
(M)	MEDIA
(T)	TELEPHONE
(C)	CONDUIT
(D)	DATA
(V)	VIDEO
(A)	AV
(S)	SPRINKLER
(R)	RECORDING
(E)	ELECTRICAL
(M)	MEDIA
(T)	TELEPHONE
(C)	CONDUIT
(D)	DATA
(V)	VIDEO
(A)	AV
(S)	SPRINKLER
(R)	RECORDING
(E)	ELECTRICAL
(M)	MEDIA
(T)	TELEPHONE
(C)	CONDUIT
(D)	DATA
(V)	VIDEO
(A)	AV
(S)	SPRINKLER
(R)	RECORDING
(E)	ELECTRICAL
(M)	MEDIA
(T)	TELEPHONE
(C)	CONDUIT
(D)	DATA
(V)	VIDEO
(A)	AV
(S)	SPRINKLER
(R)	RECORDING
(E)	ELECTRICAL
(M)	MEDIA
(T)	TELEPHONE
(C)	CONDUIT
(D)	DATA
(V)	VIDEO
(A)	AV
(S)	SPRINKLER
(R)	RECORDING
(E)	ELECTRICAL
(M)	MEDIA
(T)	TELEPHONE
(C)	CONDUIT
(D)	DATA
(V)	VIDEO
(A)	AV
(S)	SPRINKLER
(R)	RECORDING
(E)	ELECTRICAL
(M)	MEDIA
(T)	TELEPHONE
(C)	CONDUIT
(D)	DATA
(V)	VIDEO
(A)	AV
(S)	SPRINKLER
(R)	RECORDING
(E)	ELECTRICAL
(M)	MEDIA
(T)	TELEPHONE
(C)	CONDUIT
(D)	DATA
(V)	VIDEO
(A)	AV
(S)	SPRINKLER
(R)	RECORDING
(E)	ELECTRICAL
(M)	MEDIA
(T)	TELEPHONE
(C)	CONDUIT
(D)	DATA

THE EDGE BUSINESS RESOURCE CENTER
 THE CITY OF TUSCALOOSA, THE UNIVERSITY OF ALABAMA, &
 THE CHAMBER OF COMMERCE OF WEST ALABAMA
 2827 10TH AVENUE, TUSCALOOSA, ALABAMA

WARD
 SCOTT
 ARCHITECTURE

TALA Professional Services
 1000 W. UNIVERSITY BLVD., SUITE 100
 TUSCALOOSA, AL 35604
 TEL: 205-756-1111
 FAX: 205-756-1112
 WWW.TALASERVICES.COM

TALA
 PROFESSIONAL SERVICES
 ARCHITECTS
 ENGINEERS
 INTERIORS
 PLANNING
 ENVIRONMENTAL
 SCIENTISTS

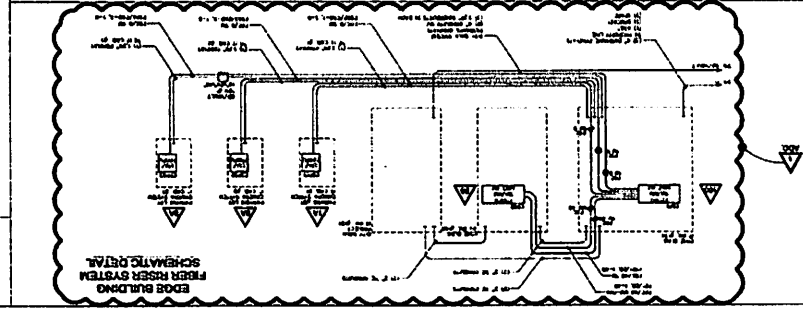
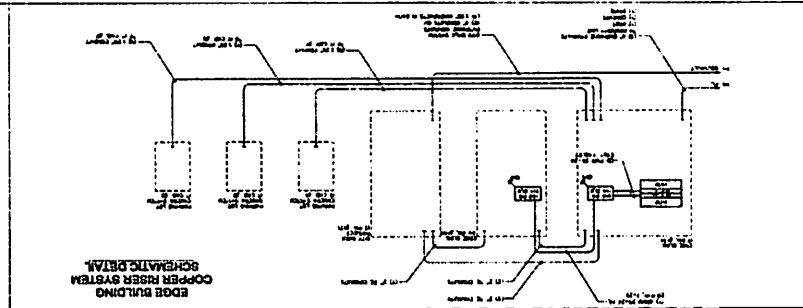
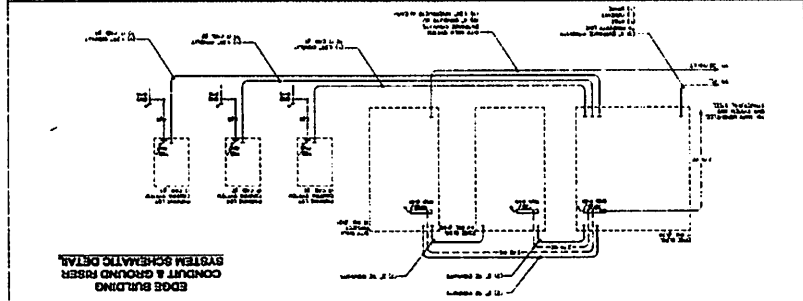
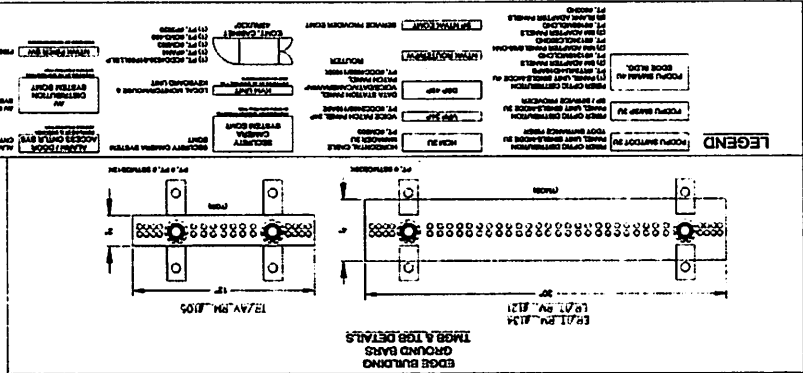
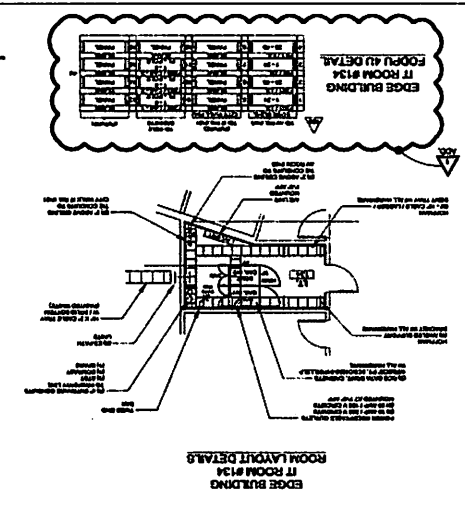
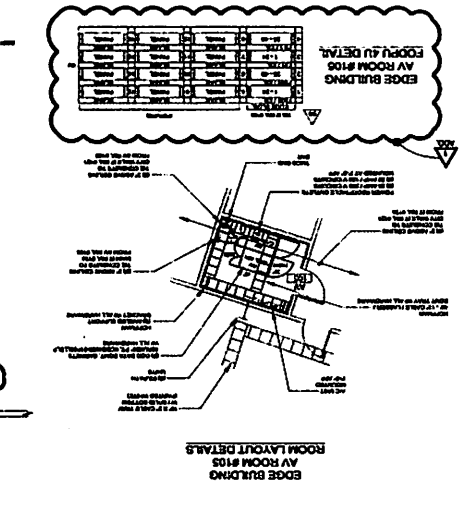
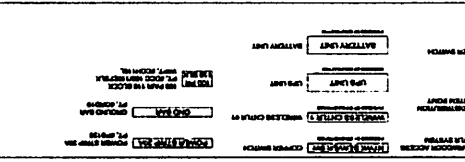
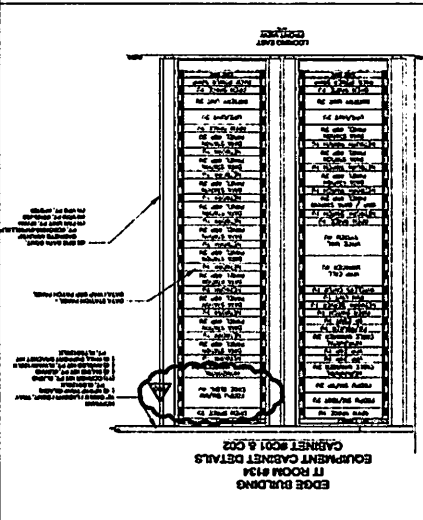
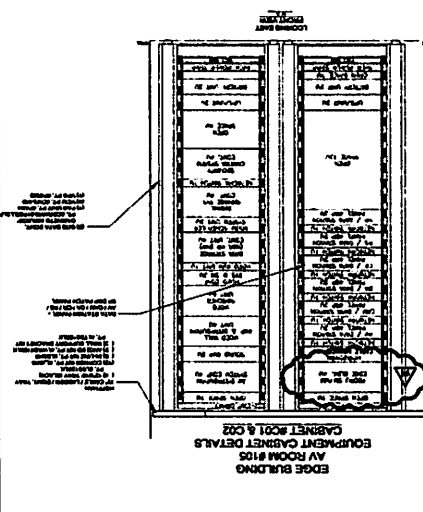

THE EDGE BUSINESS RESOURCE CENTER
IT / COMM. POLE MOUNT CABINET / BOX
TYPICAL DETAIL: 16" X 16" X 8"

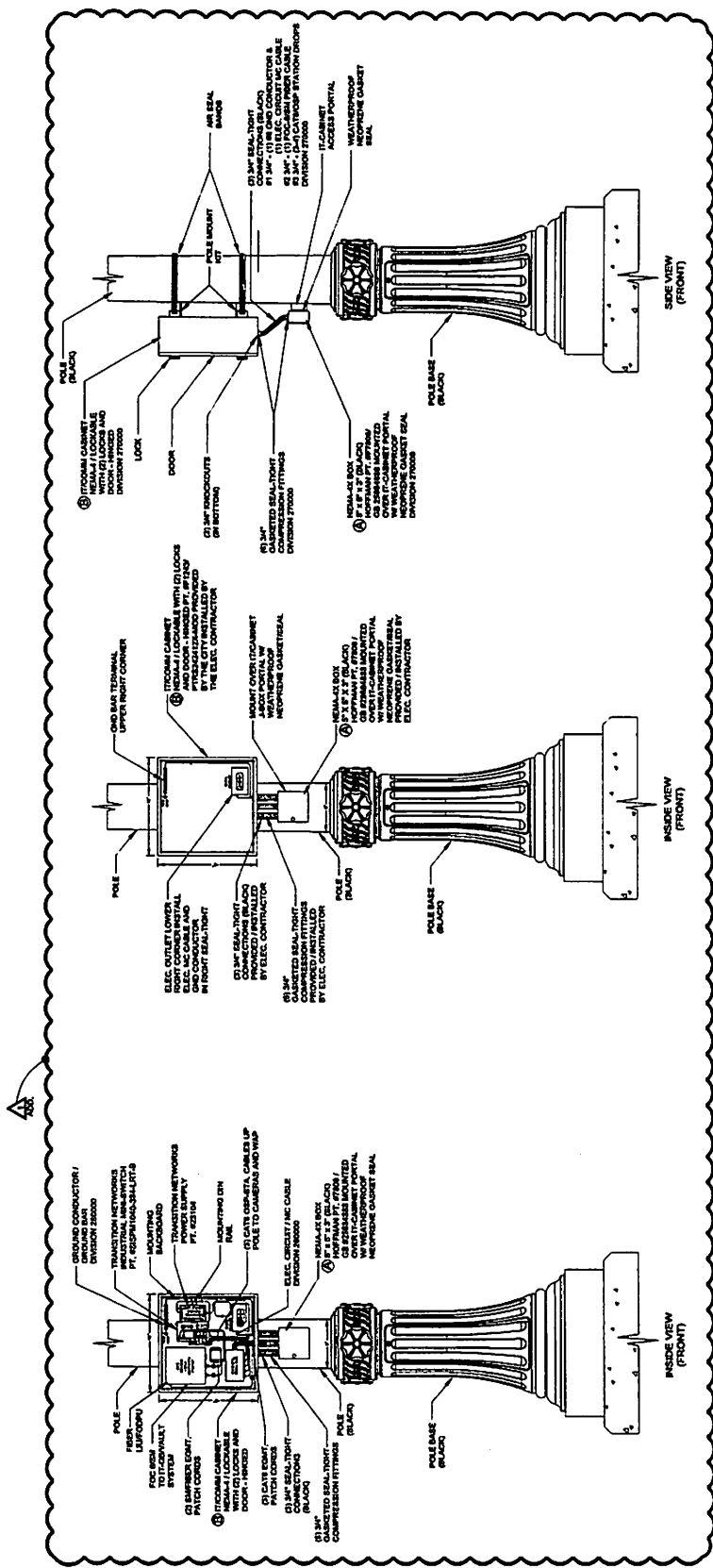

1. THE USER SHALL PROVIDE ALL NECESSARY PERMITS AND APPROVALS FOR THE INSTALLATION AND OPERATION OF THE EQUIPMENT.
2. THE USER SHALL BE RESPONSIBLE FOR THE PROTECTION AND MAINTENANCE OF THE EQUIPMENT AND FOR THE SAFETY OF ALL PERSONNEL.
3. THE USER SHALL BE RESPONSIBLE FOR THE PROTECTION AND MAINTENANCE OF THE EQUIPMENT AND FOR THE SAFETY OF ALL PERSONNEL.
4. THE USER SHALL BE RESPONSIBLE FOR THE PROTECTION AND MAINTENANCE OF THE EQUIPMENT AND FOR THE SAFETY OF ALL PERSONNEL.
5. THE USER SHALL BE RESPONSIBLE FOR THE PROTECTION AND MAINTENANCE OF THE EQUIPMENT AND FOR THE SAFETY OF ALL PERSONNEL.

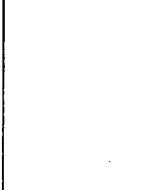

THE CITY OF TUSCALOOSA, THE UNIVERSITY OF ALABAMA, &
THE CHAMBER OF COMMERCE OF WEST ALABAMA,
2827 10TH AVENUE, TUSCALOOSA, ALABAMA

CONTRACTOR INFORMATION	
DATE:	6/20/17
PROJECT NO.:	15479
REVISED:	
REVISIONS:	
DATE:	6/20/17
BY:	
REVISIONS:	
DATE:	6/20/17
BY:	
REVISIONS:	
DATE:	6/20/17
BY:	
REVISIONS:	
DATE:	6/20/17
BY:	
REVISIONS:	

TALAI Professional Services	
1715 Adams Blvd, Birmingham, AL 35203	7700 Parkway East, Suite 1000, Birmingham, AL 35208
www.talainet.com	www.talainet.com
TALAI PROJECT # AL-2017-0001	REVISION #
DATE	DATE
DATE	DATE
DATE	DATE
DATE	DATE
DATE	DATE
DATE	DATE
DATE	DATE
DATE	DATE

Typical IT-Cabinet Detail Drawing
TD 303
REV: 04.28.17

Ward Scott Architecture
Ward Scott
Ward Scott

TALA / Professional Services
 1115 20TH STREET SOUTH, SUITE 800
 TALA, ALABAMA 35099
 www.talapro.com

ARCHITECT
 WARD SCOTT ARCHITECTURE
 2711 SOUTH LOOP WEST
 FORT LAUDERDALE, FL 33481

MECHANICAL, ELECTRICAL, & PLUMBING ENGINEER
 TALA PROJECT NO. TALA001
 PROJECT NAME: TALA
 PROJECT ADDRESS: 1115 20TH STREET SOUTH, SUITE 800, TALA, ALABAMA 35099
 DATE: 02/28/17

THE EDGE BUSINESS RESOURCE CENTER
 TYPICAL POLE PORTALS OPENINGS /
 NEMA BOX / CAMERA / WAP DETAILS

DETAIL - IT/CABINET J-BOX
 NEMA 4X - 5" X 5" X 3"
 (BLACK) W/GASKETED COVER

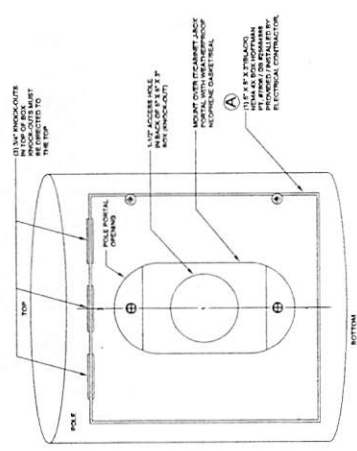

DETAIL - CAM PORTAL
 NEMA 4X - 5" X 5" X 3"
 (BLACK) W/GASKETED COVER

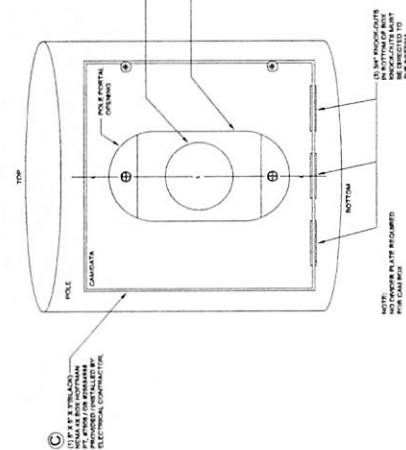

DETAIL - WAP PORTAL
 NEMA 4X - 5" X 5" X 3"
 (BLACK) W/GASKETED COVER

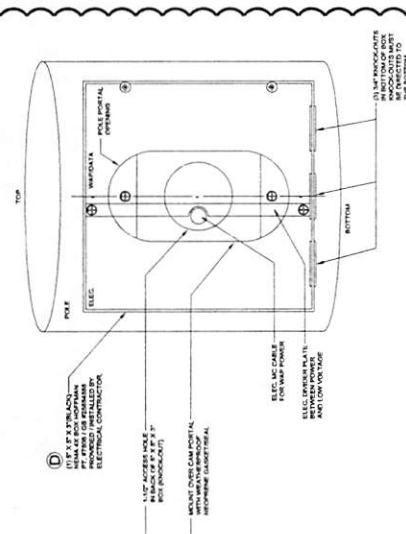

DETAIL - WAP
 NEMA 4X - 5" X 5" X 3" BOX W/
 SEAL-TIGHT (BLACK) CONDUITS
 FOR CONNECTIONS TO WAP

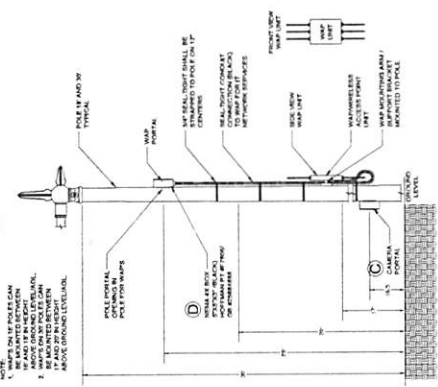

DETAIL - CAM
 NEMA 4X - 5" X 5" X 3" BOX W/
 SEAL-TIGHT (BLACK) CONDUITS
 FOR CONNECTIONS TO CAMERAS

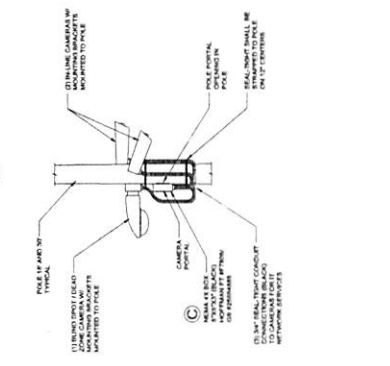

1. THE CONTRACTOR SHALL PROVIDE ALL NECESSARY MATERIALS AND LABOR FOR THE INSTALLATION OF THE PORTALS AND CONNECTIONS.
 2. THE PORTALS SHALL BE MOUNTED TO THE FRONT OF THE POLE.
 3. THE PORTALS SHALL BE MOUNTED TO THE FRONT OF THE POLE.
 4. THE PORTALS SHALL BE MOUNTED TO THE FRONT OF THE POLE.
 5. THE PORTALS SHALL BE MOUNTED TO THE FRONT OF THE POLE.



ADDENDUM NO. 2:

Date: March 3, 2017
 Project: The EDGE Business Resource Center
 Owner: The City of Tuscaloosa
 Owner's Project No: A16-1320 (Previously City #A14-1210)
 Architect: Ward Scott Architecture, Inc.

This Addendum forms a part of the Contract Documents and modifies the original Bid Documents dated July 30, 2015, as noted below.

Acknowledge receipt of this Addendum in the location provided on the Bid Proposal Form.

1.1 GENERAL

- A. All Trade Packages will bid all alternates. If there is no cost change in a certain trade it should be bid as \$0.00.
- B. See attached RH Smith and Associates Addendum

1.2 SPECIFICATIONS AND DRAWINGS

A. Specifications:

1. Refer to Specification Section 042000 – Unit Masonry
 - a. Page 5 – Paragraph 2.4.
 - 1) Paragraph D.1.a. – Add the following:
 - 5) Spec Mix, Inc.
 - 2) Paragraph F.1 – Add the following:
 - e. Spec Mix, Inc.
 - 3) Paragraph G.1.a. – Add the following:
 - 2) Spec Mix, Inc.
2. Refer to Specification Section 055813 – Column Covers:
 - a. Page 2 – Paragraph 2.1.A Manufacturers. Revise as Follows:
 - A. Acceptable Manufacturers:
 1. Abrams Architectural Products, Inc.
 2. ATAS International, Inc.
 3. Centria, an NCI Building Systems Company
 4. Fry Reglet Architectural Metals
 5. Peterson Pac-Clad
 6. Or Approved Equal Conforming to the Plans and Specifications
3. Refer to Specification Section 061600 – Sheathing:
 - a. Page 1. Delete Paragraph 2.2.
 - b. All exterior wall sheathing on this project whether indicated as “gypsum sheathing”, “sheathing” or by any other implied term meant to indicate sheathing, shall be provided as specified under Paragraph 2.3.
4. Refer to Specification Section 072726 – Fluid-Applied Membrane Air Barriers:
 - a. Page 3 – Paragraph 2.3.A.2.a. Add the following:
 - 4) GE Elemax 2600 AWB
5. Refer to Specification Section 074113.16 – Standing-Seam Metal Roof Panels:
 - a. Page 3 – Paragraph 2.1.B.1. Add the following:
 - j. Fabral

6. Refer to Specification Section 075419 – PVC Roofing:
 - a. Page 4 – Paragraph 2.3.A.2. Revise as follows:
 2. Equal roof systems by Garland, Imetco, Sika Sarnafil, Versico, and Mule-Hide Products Co. are acceptable.
7. Refer to Specification Section 095113 – Acoustical Panel Ceilings:
 - a. Page 6 – Paragraph 3.4.A.1.a. Revise as follows:
 - a. Panel: "Ultima Tegular fine texture," #1951, Armstrong World Industries, Inc., USG Mars 86786 or equivalent.
8. Delete Specification Section 077200 Roof Accessories in its entirety. Roof Access shall be provided under Specification Section 083113 Access Doors and Frames
9. Refer to Specification Section 105513 – Postal Specialties:
 - a. Page 4 – Add the following Paragraph 2.7:

2.7. MANUFACTURERS

- A. Basis of Design Product: Salsbury Industries, Model #3713D-14.
 1. Quantity of Units to accommodate requirements indicated in plans and specifications.
 - B. Or Approved Equal Conforming to the Plans and Specifications
10. Replace Specification Section 108200 Toilet, Bath, and Laundry Accessories in its entirety with the attached Revised Section.
 11. Refer to Specification Section 104413 – Fire Protection Cabinets:
 - a. Page 3 – Paragraph 3.1.A, add the following subparagraph 1:
 1. All fire protection cabinets shall be sized to install in a wall consisting of 3 5/8" studs and 5/8" gypsum wall board.
 12. Refer to Specification Section 122413 – Roller Window Shades:
 - a. Page 1 – Paragraph 1.3.F, replace this paragraph in its entirety with the following:
 - F. Roller Shade Schedule: Include at the following Locations:
 1. Openings Indicated on Drawing A101 as SF4, SF5, SF6, and SF7, and SF8 and SF11 at Training Room 103.
 13. Refer to Specification Section #129300 – Site Furnishings:
 - a. Page 1 – Paragraph 2.1.A.1, add the following:
 - c. Finish: Powder Coated Steel, Silver Color
 - b. Page 1 – Paragraph 2.1.B, replace in its entirety as follows:
 - B. Manufacturers:
 1. Basis-of-Design Product: American Bicycle Security Company, Bike Hitch.
 2. Accepted Manufacturers: Belson Outdoors, LLC; Madrax by Graber Manufacturing, Inc., or others conforming to the plans and specifications.

Diagrammatic drawing indicated at right.
 - c. For information, Bollard Detail is located in drawings at 9/AC02 and locations indicated on AC01 and AC02. Bike Rack locations are indicated on A101.
 - B. Drawings:
 1. Refer to the attached Sheet SD-1 for information regarding the monument sign included in Alternate #4.
 2. Replace Sheet A111 Enlarged Plans with the attached Revised Sheet. Note revision of Mark 'B' to indicate shower grab bar and Mark 'M' to indicate Mop and Broom Holder location.

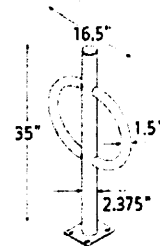

1.3 ATTACHED TO ADDENDUM

- A. RH Smith and Associates Addendum
- B. Supplemental Drawing SD-1
- C. Revised Specification Section 108200 Toilet, Bath, and Laundry Accessories
- D. Architectural Sheets A111

END OF ADDENDUM

ADDENDUM



Smith, Stegall & associates p.c.

◆
Consulting Engineers

◆
2110 Eighth Street, Tuscaloosa, AL 35401

◆
Phone / Fax 205 345 4402

PROJECT: The Edge Business Resource Center	ENG JOB # 1436	DATE: February 27, 2017
--	--------------------------	-----------------------------------

PLUMBING:

1. Specification section 221005: Storm water piping to be same as sanitary sewer piping. Service weight hub and spigot below grade and service weight no hub above grade.
2. Breakroom 128: Sink to be P-15.

END OF ADDENDUM

SECTION 108200 – TOILET, BATH, AND LAUNDRY ACCESSORIES

PART 1 - GENERAL

1.1 RELATED DOCUMENTS

- A. Drawings and general provisions of the Contract, including General and Supplementary Conditions and Division 1 Specification Sections, apply to this Section.

1.2 SUMMARY

- A. This Section includes the following:
 1. Public-use washroom accessories.
 2. Underlavatory guards.
 3. Custodial accessories.
- B. Owner-Furnished/Contractor Installed Material: Toilet Tissue Dispensers and Paper Towel Dispensers in Public Restrooms.
 1. Contractor to install.
- C. Related Sections include the following:
 1. Division 8 Section "Mirrors" for frameless mirrors.
 2. Division 9 Section "Ceramic Tile" for ceramic toilet and bath accessories.

1.3 SUBMITTALS

- A. Product Data: For each type of product indicated. Include the following:
 1. Construction details and dimensions.
 2. Anchoring and mounting requirements, including requirements for cutouts in other work and substrate preparation.
 3. Material and finish descriptions.
 4. Features that will be included for Project.
 5. Manufacturer's warranty.
- B. Samples: Full size, for each accessory item to verify design, operation, and finish requirements.
 1. Approved full-size Samples will be returned and may be used in the Work.
- C. Product Schedule: Indicating types, quantities, sizes, and installation locations by room of each accessory required.
 1. Identify locations using room designations indicated on Drawings.
- D. Maintenance Data: For toilet and bath accessories to include in maintenance manuals.

1.4 QUALITY ASSURANCE

- A. Source Limitations: For products listed together in the same articles in Part 2, provide products of same manufacturer unless otherwise approved by Architect.

1.5 COORDINATION

- A. Coordinate accessory locations with other work to prevent interference with clearances required for access by people with disabilities, and for proper installation, adjustment, operation, cleaning, and servicing of accessories.
- B. Deliver inserts and anchoring devices set into concrete or masonry as required to prevent delaying the Work.

PART 2 - PRODUCTS

2.1 MATERIALS

- A. Stainless Steel: ASTM A 666, Type 304, 0.0312-inch (0.8-mm) minimum nominal thickness, unless otherwise indicated.
- B. Brass: ASTM B 19 flat products; ASTM B 16 (ASTM B 16M), rods, shapes, forgings, and flat products with finished edges; or ASTM B 30, castings.
- C. Steel Sheet: ASTM A 1008/A 1008M, Designation CS (cold rolled, commercial steel), 0.0359-inch (0.9-mm) minimum nominal thickness.

- D. Galvanized Steel Sheet: ASTM A 653/A 653M, with G60 (Z180) hot-dip zinc coating.
- E. Galvanized Steel Mounting Devices: ASTM A 153/A 153M, hot-dip galvanized after fabrication.
- F. Fasteners: Screws, bolts, and other devices of same material as accessory unit and tamper-and-theft resistant where exposed, and of galvanized steel where concealed.
- G. Chrome Plating: ASTM B 456, Service Condition Number SC 2 (moderate service).

2.2 TOILET AND BATH ACCESSORY SCHEDULE

- A. Soap Dispensers
 - 1. Bobrick #B-40
- B. Paper Towel Dispensers
 - 1. Bay West #86800 or Bobrick 72860
- C. Toilet Paper Dispensers
 - 1. Kimberly-Clark #09551, Insight JRT Escort, Jumbo Roll Tissue Dispenser, http://www.kcprofessional.com/us/product-details.asp?site=kcprofessional_com_us&client=kcprofessional_com_us&proxystylesheet=kcprofessional_com_us&output=xml_no_dtd&q=09551&search=v1&searchtext=09551&btnGo=Go
- D. Sanitary Napkin Receptacle
 - 1. Rubbermaid 6140, Sanitary Napkin Receptacle with Rigid Liner, <http://www.rcpworksmarter.com/rcp/products/detail.jsp?rcpNum=6140&search=6140>
 - a. Locations: Rest Room 120, Rest Room 127, Women 132
- E. Grab Bars:
 - 1. Products: Available products include the following: Bobrick #B-5806 series.
 - 2. Stainless-Steel Nominal Thickness: Minimum 0.05 inch (1.3 mm).
 - 3. Mounting: Concealed with manufacturer's standard flanges and anchors.
 - 4. Gripping Surfaces: Manufacturer's standard slip-resistant texture.
 - 5. Outside Diameter at adult toilets: 1-1/2 inches (32 mm).
- F. Mirror Unit:
 - 1. Products: Available products include the following: Bobrick #B-165 -#1836. See drawings for locations.
 - 2. Stainless-Steel, Channel-Framed Mirror: Fabricate frame from stainless-steel channels in manufacturer's standard satin or bright finish with square corners mitered to hairline joints and mechanically interlocked.
- G. Mop and Broom Holder:
 - 1. Products: Available products include the following: Bobrick #B-224.
 - 2. Mop and Broom Holder with Utility Shelf: 36-inch- (914-mm-) long unit fabricated of minimum nominal 0.05-inch- (1.3-mm-) thick stainless steel with shelf; support brackets for wall mounting; three hooks for wiping rags; four spring-loaded, rubber hat, cam-type, mop/broom holders mounted on front of shelf; and approximately 1/4-inch- (6-mm-) diameter, stainless-steel rod suspended beneath shelf for drying rags.
 - a. Location: Supply 107
- H. Robe Hooks:
 - 1. Products: Available products include the following: Bobrick #B-21. See drawings for locations.

2.3 PUBLIC-USE SHOWER ROOM ACCESSORIES

- A. Shower Curtain Rod
 - 1. Description: 1-1/4-inch (32-mm) OD; fabricated from nominal 0.05-inch- (1.3-mm-) thick stainless steel.
 - 2. Mounting Flanges: Stainless-steel flanges designed for exposed fasteners
 - 3. Finish: No. 4 (satin).
- B. Shower Curtain
 - 1. Products: Available products include the following: Bobrick #B-204-2. Provide appropriate hooks as recommended by the manufacturer.
- C. Folding Shower Seat:
 - 1. Configuration: L-shaped seat, designed for wheelchair access.
 - 2. Seat: Phenolic or polymeric composite of slat-type or one-piece construction in color as selected by Architect.
 - 3. Mounting Mechanism: Stainless steel, No. 4 finish (satin).
 - 4. Dimensions: 2'-10"x1'-5".

D. Shower Grab Bars:

1. Products: Available products include the following: Bobrick #B-5837.
2. Stainless-Steel Nominal Thickness: Minimum 0.05 inch (1.3 mm).
3. Mounting: Concealed with manufacturer's standard flanges and anchors.
4. Gripping Surfaces: Manufacturer's standard slip-resistant texture.
5. Outside Diameter : 1-1/2 inches (32 mm).

2.4 UNDERLAVATORY GUARDS

- A. Available Manufacturers: Subject to compliance with requirements, manufacturers offering products that may be incorporated into the Work include, but are not limited to, the following:
- B. Manufacturers: Subject to compliance with requirements, provide products by one of the following:
- C. Basis-of-Design Product: The design for accessories is based on products indicated. Subject to compliance with requirements, provide the named product or a comparable product by one of the following:
 1. Plumberex Specialty Products, Inc.
 2. TCI Products.
 3. Truebro, Inc.
- D. Underlavatory Guard:
 1. Basis-of-Design Product: TCI Products #SG-101 and 102 for exposed stops and P-traps.
 2. Description: Insulating pipe covering for supply and drain piping assemblies, which prevent direct contact with and burns from piping, and allow service access without removing coverings.
 3. Material and Finish: Antimicrobial, molded-plastic, white.

2.5 CUSTODIAL ACCESSORIES

- A. Basis-of-Design Product: The design for accessories is based on products indicated. Subject to compliance with requirements, provide the named product or a comparable product by one of the following:
 1. A & J Washroom Accessories, Inc.
 2. American Specialties, Inc.
 3. Bobrick Washroom Equipment, Inc.
 4. Bradley Corporation.
- B. Mop and Broom Holder:
 1. Basis-of-Design Product: Bobrick Washroom Equipment, Inc. #B-224
 2. Description: Unit with shelf, hooks, holders, and rod suspended beneath shelf.
 3. Length: 30.
 4. Hooks: Two.
 5. Mop/Broom Holders: Three, spring-loaded, rubber hat, cam type.
 6. Material and Finish: Stainless steel, No. 4 finish (satin).
 - a. Shelf: Not less than nominal 0.05-inch- (1.3-mm-) thick stainless steel.
 - b. Rod: Approximately 1/4-inch- (6-mm-) diameter stainless steel.
 7. Location: Supply 107

2.6 FABRICATION

- A. General: Fabricate units with tight seams and joints, and exposed edges rolled. Hang doors and access panels with full-length, continuous hinges. Equip units for concealed anchorage and with corrosion-resistant backing plates.
- B. Keys: Provide universal keys for internal access to accessories for servicing and resupplying. Provide minimum of ten keys to Owner's representative.

PART 3 - EXECUTION**3.1 INSTALLATION**

- A. Install accessories according to manufacturers' written instructions, using fasteners appropriate to substrate indicated and recommended by unit manufacturer. Install units level, plumb, and firmly anchored in locations and at heights indicated.
- B. Grab Bars: Install to withstand a downward load of at least 250 lbf (1112 N), when tested according to method in ASTM F 446.

3.2 ADJUSTING AND CLEANING

- A. Adjust accessories for unencumbered, smooth operation. Replace damaged or defective items.
- B. Remove temporary labels and protective coatings.
- C. Clean and polish exposed surfaces according to manufacturer's written recommendations.

END OF SECTION 10801



JOB NO.: 13-073

DATE: 03/02/17

REVISIONS:

SD-1

1
**MONUMENT
 SIGN ELEV.**
 SCALE: 3/8" = 1'-0"

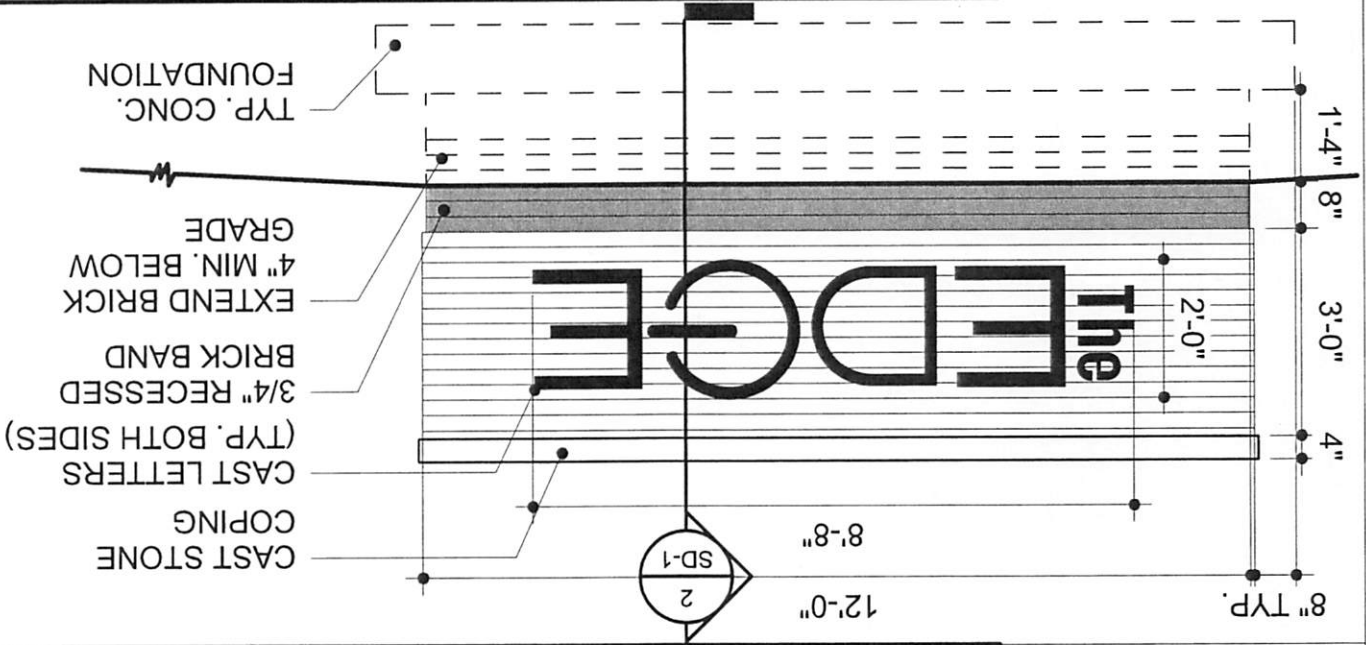

2
**MONUMENT
 SIGN SECTION**
 SCALE: 3/8" = 1'-0"

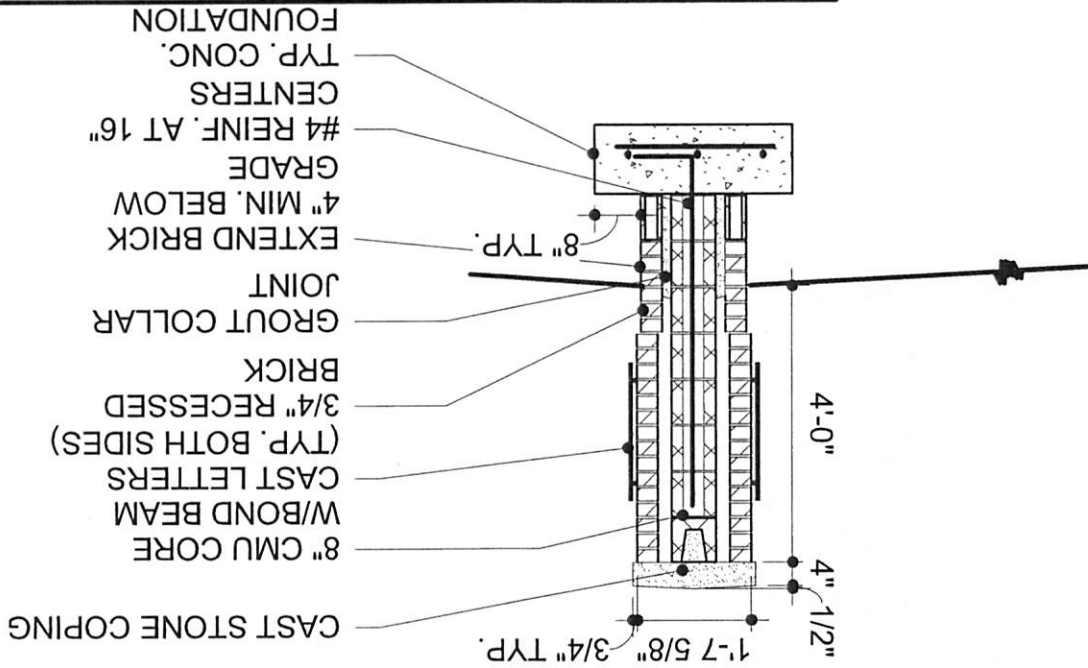

REVISIONS	DATE	BY



- ACCESSORIES LEGEND**
- 1 GRAB BAR 48"
 - 2 GRAB BAR 48"
 - 3 GRAB BAR 48"
 - 4 SOAP DISPENSER
 - 5 PAPER TOWEL DISPENSER
 - 6 TOILET TISSUE DISPENSER
 - 7 SHOWER CURTAIN
 - 8 FOLDING BENCH
 - 9 ROSE HOOK
 - 10 LITTER
 - 11 LITTER
 - 12 LITTER

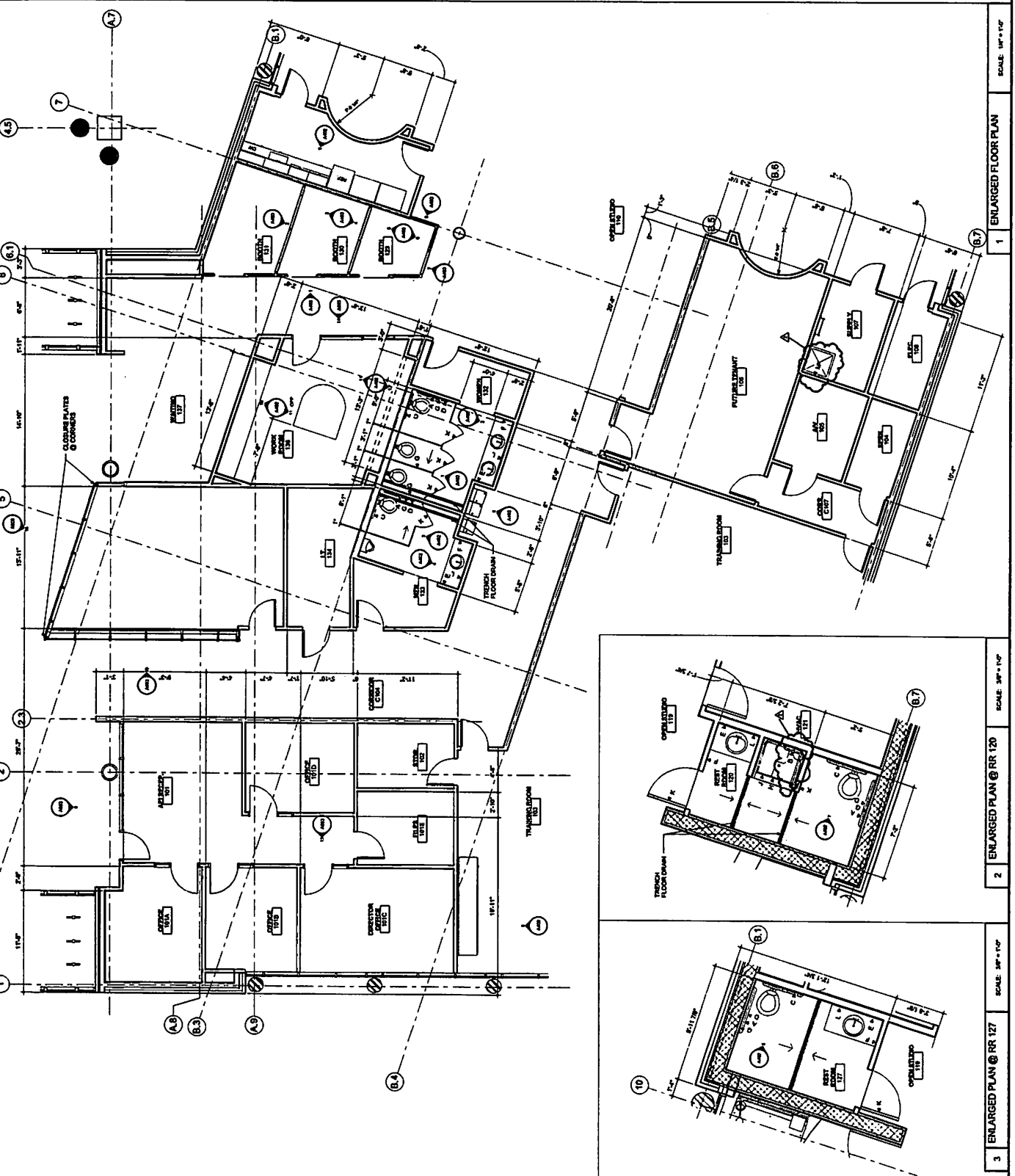

1 ENLARGED FLOOR PLAN SCALE: 1/8" = 1'-0"
 2 ENLARGED PLAN @ RR 120 SCALE: 3/8" = 1'-0"
 3 ENLARGED PLAN @ RR 127 SCALE: 3/8" = 1'-0"

A111



ADDENDUM NO. 3:

Date: March xx, 2017
Project: The EDGE Business Resource Center
Owner: The City of Tuscaloosa
Owner's Project No: A16-1320 (Previously City #A14-1210)
Architect: Ward Scott Architecture, Inc.

This Addendum forms a part of the Contract Documents and modifies the original Bid Documents dated July 30, 2015, as noted below.

Acknowledge receipt of this Addendum in the location provided on the Bid Proposal Form.

1.1 GENERAL

- A. See attached Pre-Bid Conference Sign-In Sheets

1.2 SPECIFICATIONS AND DRAWINGS

- A. Specifications:

- 1. Refer to Summaries of Work.

- a. The following language shall pertain to all Trades. All Trade Packages will bid all alternates. If there is no cost change in a certain trade it should be bid as \$0.00.

Alternates:

- 1. Alternate 1: Fence
- 2. Alternate 2: HVAC Controls
- 3. Alternate 3: Paint at High Steel
- 4. Alternate 4: Monument Sign

- b. Crushed Aggregate Base at Sidewalks, Curb and Gutter as specified in Section 022400 Shall be in 02-General Package.
- c. All Staking for building corners, columns, foundations, etc. shall be provided by the 02-General Trade Contractor. Balance of site staking shall be provided by the 01-Site Trade Contractor.
- 2. Refer to Specification Section 072726 – Fluid-Applied Membrane Air Barriers:
 - a. Page 3 – Paragraph 2.3.A.2.a. Add the following:
 - 5) BASF Masterseal AWB
 - 3. Refer to Specification Section 105113 – Metal Lockers:
 - a. Page 2 – Paragraph 2.3.B. Revise as follows:
 - B. Configuration: 21 triple tier units for a total of 63 lockers.

- B. Drawings:

- 1. For information, Panel Signage is detailed on Sheet G102 and scheduled on A002.

1.3 ATTACHED TO ADDENDUM

- A. Pre-Bid Conference Sign-In Sheets

END OF ADDENDUM



ADDENDUM NO. 4:

Date: March 22, 2017
 Project: The EDGE Business Resource Center
 Owner: The City of Tuscaloosa
 Owner's Project No: A16-1320 (Previously City #A14-1210)
 Architect: Ward Scott Architecture, Inc.

This Addendum forms a part of the Contract Documents and modifies the original Bid Documents dated July 30, 2015, as noted below.

Acknowledge receipt of this Addendum in the location provided on the Bid Proposal Form.

1.1 GENERAL

- A. The date and time for receipt of bids for this project has been changed to **Thursday, March 30, 2017, at 2:00 P.M.** The location of receipt of bids of **Tuscaloosa City Hall Council Chambers, 2201 University Blvd, Tuscaloosa, Alabama** is unchanged.
- B. Refer to attached Burk-Kleinpeter Addendum and Unit Price Schedule
- C. Refer to attached RH Smith and Associates Addendum
- D. See attached Electrical RFI Responses

1.2 SPECIFICATIONS AND DRAWINGS

- A. Specifications:
 - 1. Refer to Summaries of Work – Trade Contractor Bid Package EDGE – 02 General
 - a. Scope of Work Item #9. Revise as follows:
 - 9. This Trade Contractor is specifically responsible for all temporary barricades and signage as required for construction of this project. Limits of temporary barricades shall be assumed to be the property lines. Generally, temporary barricades shall be considered temporary construction fencing.
 - b. Scope of Work Item #19. Revise as follows:
 - 19. At the request of the Construction Manager, This Trade Contractor shall furnish equipment equivalent to Skidsteer for grading site roads and ruts. Duration of time for furnishing of said equipment shall be 12 months.
 - 2. Refer to Summaries of Work – Trade Contractor Bid Package EDGE – 04 Roofing
 - a. For clarification, Formed Metal Roof Panels as specified in Section 074213.13 shall be provide by this trade contractor.
 - 3. Refer to Specification Section 012100 Allowances Revise Paragraph 3.3.A as follows:
 - 1. Provide \$4,000 for material, fabrication, and installation of edge-lit signage at west wall face. All other cast letter, panel, plaque and other signage shall be provided in the base bid and alternates as indicated in the Construction Documents.
 - 4. Delete Specification Section 023113 Chain Link Fences and Gates in its entirety. Temporary Construction Fencing is specified in Section 015000 Temporary Facilities and Controls.
 - 5. Refer to Specification Section 021400 – Unit Paving:
 - a. Page 3 – Paragraph 2.3.A. Add the following as Subparagraph 1:
 - 1. Thickness: 4 inches.
 - 6. Refer to Specification Section 053000 – Acoustic Roof Deck/Ceiling System:
 - a. Page 3 – Paragraph 2.1.A. Add the following as Subparagraph 1:
 - 1. Vulcraft 2.0DA 18 GA and 16 GA products, in lieu of the Epic Toris A 18GA product specified, are acceptable alternates as long as they are always used in three span conditions. Deck manufacturer to verify all spans for conformance prior to bidding.

7. Refer to Specification Section 074113.16 – Standing Seam Metal Roof Panels
 - a. Page 5 – Paragraph 2.8.A.1.a. Revise as follows:
 - 1) Thickness: Total of 4"
 - 2) R-Value: Minimum of 21.0
 8. Refer to Specification Section 084113 – Aluminum Framed Entrances and Storefronts:
 - a. Page 3 – Paragraph 2.2.A. Revise as follows:
 2. Exterior: Nominal 2" by 6" profile.
 3. Interior: Nominal 2" x 4" profile.
 4. 4" wide profiles shall be 2" profiles installed back-to-back.
 9. Replace Specification Section 088000 Glazing in its entirety with the attached revised specification section.
 10. Refer to Specification Section 096813 – Tile Carpeting:
 - a. Page 2 – Paragraph 3.3.B. Revise as follows:
 - B. Installation Method:
 1. Pattern: As indicated on Finish Schedule
 2. Method: Manufacturer's recommended adhesive.
 - b. Page 3 – Paragraph 3.3.C. Revise as follows:
 - C. Cutting of Carpet Tile:
 1. At curved patterns: Water-jet/Laser cut carpet tiling. Bind or seal cut edges as recommended by carpet tile manufacturer.
 2. At straight edges and dissimilar features: Cut and fit carpet tile to butt tightly to vertical surfaces, permanent fixtures, and built-in furniture including cabinets, pipes, outlets, edgings, thresholds, and nosings. Bind or seal cut edges as recommended by carpet tile manufacturer.:
 11. Refer to Specification Section 101416 – Plaques:
 - a. Page 3 – Paragraph 2.1.A. Add the following:
 8. Size: 24" wide x 36" high
 9. Location: Vestibule C102, South Wall
 12. Refer to Specification Section 101419 – Dimensional Letter Signage:
 - a. Page 2 – Paragraph 2.2.A. Add the following:
 7. Standoff Distance: ¾ inch
- B. Drawings:
1. Refer to Sheet L-2.
 - a. Revise depth of topsoil and rototilling to indicate 12" in lieu of 6" at Detail C. Planting Note #2 indicating 12" of topsoil shall govern.
 - b. All seeded and mulched areas shall receive 4" of topsoil matching that of sodded locations as required by Specification Section 028300, Paragraph 1.2.D.
 2. Refer to Sheet AC01.
 - a. West sidewalk extents shall be as indicated in Civil documents.
 - b. Limits of concrete drive paving shall be as indicated in Civil documents.
 3. Replace Sheets G102, A002, A003, A101, A311 and A312 in their entirety with the attached revised Sheets.
 4. Refer to Sheet A501, Detail 1 Reflected Ceiling Plan. All references to Axiom Edge shall be revised to indicate 5" depth.
 5. Refer to Sheet TD101.
 - a. All DataCom voice and data system conduits from the floor boxes shall be homerun back to IT-Comm. Room #134, terminated at the base of the backboards. All DataCom voice and data cabling shall be OSP Type-Water Blocking Cable homerun to IT-Comm. Room #134, terminated in the Equipment Cabinets on the Data Station Panels. (All area floor boxes.)
 - b. All AV system conduits from the floor boxes shall be homerun back to AV-Comm. Room #105, terminated at the base of the backboards. All AV system cabling shall be OSP Type-Water Blocking Cable homerun to AV-Comm. Room #105, terminated in the Equipment Cabinets on the AV Station Equipment/Panels. (All area floor boxes.)

1.3 ATTACHED TO ADDENDUM

- A. Burk-Kleinpeter Addendum and Unit Price Schedule
- B. BKI Revised Sheets C102, C201, C202, C203, C204, C205, C206, C207, C209, and Supplemental Sheets SD-2, SD-3, and SD-4.
- C. RH Smith and Associates Addendum
- D. Electrical RFIs 1 & 2
- E. Revised Sheets G102, A002, A003, A101, A311 and A312
- F. Revised Specification Section 088000 Glazing

END OF ADDENDUM

BURK-KLEINPETER, INC.

ENGINEERS, ARCHITECTS, PLANNERS, ENVIRONMENTAL SCIENTISTS
2900 8TH STREET
TUSCALOOSA, AL 35401
PHONE (205) 759-3221 FAX (205) 759-9166

ADDENDUM NO. 4

The EDGE Business Resource Center City of Tuscaloosa Project No. A16-1320 March 21, 2017

This addendum forms a part of the Contract Documents and modifies the original Bidding Documents dated July 30, 2015.

ITEM NO. 1 – REVISION UNIT PRICE SCHEDULE:

Replace the Unit Price Schedule for Sitework found within the Contract Documents in its entirety with the attached. Review the revised Unit Price Schedule dated March 21, 2017 and note all additions and deletions.

ITEM NO. 2 – REVISION SPECIFICATION SECTION 022000 – EARTHWORK:

Page 2 – Paragraph 1.5.B.2. Revise as follows:

2. Payable quantities shall be in-place volumes determined as follows:
 - a. Cut Sections: The finished subgrade elevation shown on the Contract Documents minus the final unsuitable material removal elevation, as determined by the Engineer, times the area required to perform the work.
 - b. Fill Sections: The existing subgrade elevation shown on the Contract Documents minus the final unsuitable material removal elevation, as determined by the Engineer, times the area required to perform the work.

ITEM NO. 3 – REVISION SHEET C102:

The attached revised Sheet C102 dated March 15, 2017 shall replace the previously provided Sheet C102. The removal and abandonment of the existing sanitary sewer system has been revised.

ITEM NO. 4 – REVISION SHEET C201:

The attached revised Sheet C201 dated May 25, 2016 shall replace the previously provided Sheet C201. A dimension has been added for the sidewalk in the right-of-way along 10th Avenue and truncated dome pavers have been added in the sidewalk along 27th Street.

ITEM NO. 5 – REVISION SHEET C202:

The attached revised Sheet C202 dated March 15, 2017 shall replace the previously provided Sheet C202. The required asphalt overlay requirements along 27th Street have been revised. Permanent signs and parking stops have been added.

ITEM NO. 6 – REVISION SHEET C203:

The attached revised Sheet C203 dated May 25, 2016 shall replace the previously provided Sheet C203. Grading along the sidewalk and curb at the intersection of 10th Avenue and 27th Street has been revised.

ITEM NO. 7 – REVISION SHEET C204:

The attached revised Sheet C204 dated March 15, 2017 shall replace the previously provided Sheet C204. The location of the sanitary sewer lateral tie into the existing main has been revised.

ITEM NO. 8 – REVISION SHEETS C205 – C207:

The attached revised Sheets C205 – C207 dated August 2, 2016 shall replace the previously provided Sheets C205 – C207. Permanent Drainage Easements for the storm sewer outfalls along the east side of the property have been acquired and added to the plans.

ITEM NO. 9 – REVISION SHEET C209:

The attached revised Sheet C209 dated March 15, 2017 shall replace the previously provided Sheet C209. A stone pad construction exit has been added to the plans.

ITEM NO. 10 – REVISION SHEET C304:

Sheet C304 dated July 30, 2015 has been revised to add the following details:

- Sidewalk at Curb Intersection (See attached Supplemental Drawing No. 2)
- Post Mounted Sign Detail (See attached Supplemental Drawing No. 3)
- Precast Concrete Parking Stop (See attached Supplemental Drawing No. 4)

ITEM NO. 11 – CLARIFICATION SHEET C204:

A portion of the existing utilities along 10th Avenue was not included as part of the original survey for this project. The City has provided the attached 10th Avenue Existing Utilities sheet, **for information purposes only**, in order to inform the bidders of existing utilities which may be encountered during the installation of the sanitary sewer lateral for this project. As with the survey for this project, the locations of the existing underground utilities on the attached sheet are shown in an approximate manner only, as provided by utility owners. The Contractor shall be responsible for contacting Alabama One-Call to mark the utility locations during construction and for determining the exact location of all underground utilities before commencing work. The Contractor shall also be responsible for repairing/replacing any in-place utilities, whether or not shown on the survey, which are damaged during construction of this project to the satisfaction of the Engineer and the utility owner, at the Contractor's expense.

ITEM NO. 12 – BIDDER QUESTIONS:

1. Question: Who is responsible for Construction Staking on the Site Package?

Response: The Contractor will be responsible for providing construction staking.

2. Question: Who is responsible for the Watermain Extension Agreement?

Response: The City will not exercise the Water Main Extension Agreement for this project. The Contractor will be responsible for purchasing all materials for the required water improvements. Material submittals will be reviewed by City staff and a pre-construction meeting for the water main extension will be required.

3. Question: Will the Owner be providing the traffic control plan for the installation of the sanitary sewer lateral across 10th Avenue?

Response: No. The Contractor will be responsible for the development of the traffic control plan for the installation of the sanitary sewer lateral across 10th Avenue, as well as any other traffic control plans which may be required for the completion of this project. The traffic control plan(s) shall be submitted to the City and approved by them prior to the commencement of any work for

which a traffic control plan is required. The Contractor shall include all associated costs for the traffic control plan(s) in his bid.

4. Question: When is the City going to require the sanitary sewer work to be done? Can 10th Ave be shut down for the sanitary sewer work?

Response: Based on the attached revised plan for the sanitary sewer lateral tie-in, the sanitary sewer work should not require a complete road closure and the work should be able to take place during the work day.

5. Question: There is not any existing survey on the West side of 10th Ave where the proposed sanitary ties to the existing line. There could be some major conflicts due to how deep the tie in is. Can you show the existing utilities/ROW Lines/Sidewalks/Irrigation in the plans? Who is going to be responsible for the Utility Conflicts and Concrete/Sod/Irrigation repair?

Response: The location of the sanitary sewer lateral tie into the existing main has been revised so that the lateral ties into the existing 8" sewer main in 10th Avenue. The revisions are shown on the attached sheet C204 and a clarification to this sheet is included in Item No. 11 of this addendum. The Contractor will be responsible for addressing any underground utility conflicts encountered during installation of the sanitary sewer lateral, including but not limited to providing temporary support/bracing for existing utilities. Any existing curb, sidewalk, landscaping, etc. disturbed or damaged during the construction of this project shall be repaired/replaced by the Contractor at his expense.

6. Question: The proposed line is going to be really deep and only 6' from the existing power pole on the East side of 10th Ave. Is the power pole going to be relocated or held by APCO? Can the proposed sewer be moved?

Response: Alabama Power has been contacted about the proximity of the existing pole to the required sanitary sewer lateral. They said that the pole can be held, if necessary, during installation of the sanitary sewer lateral but this will need to be evaluated more closely during construction. The Contractor shall be responsible for contacting Alabama Power far enough in advance of the sanitary sewer work so that the need for holding the pole can be evaluated and, if necessary, a truck can be scheduled to hold the pole.

7. Question: The proposed sanitary line is shown to be a 4" line on the plan sheets and 6" on the unit prices. Which one is correct?

Response: The required sanitary sewer lateral will be a 4" line. This has been corrected on the attached Unit Price Schedule.

8. Question: Which plan is correct in regards to sidewalks and concrete paving? C202 (Paving) indicates a sidewalk on the west side of the building and half of the east side parking lot as concrete paving, whereas AC01 does not show either the west side sidewalk nor the concrete paving at the east parking lot. Note that demo plan C102 specifies the removal of the existing section of sidewalk on the west side that is in question.

Response: The required concrete paving and concrete sidewalk locations as shown on sheet C202 are correct.

9. Question: There are no Stop or Handicap signs on the bid sheet. Are these required as part of the project?

Response: Stop signs and Handicap Parking Signs have been included on the attached Unit Price Schedule and on the attached sheet C202.

10. Question: There is no unit item for the 15" HDPE pipe on Line D. Is this correct?

Response: The 15" HDPE pipe has been included on the attached Unit Price Schedule.

11. Question: There is no Rock Construction Exit shown on the Erosion Control Plan, is one needed?

Response: Yes. A stone pad construction exit has been added to the attached sheet C209.

12. Question: The Site Scope says to include the gas line, however, there is no gas line shown on the Civil Utility drawings. How does this need to be addressed?

Response: The requirement for gas service has been removed from the project. Please refer to the MEP bid documents for further information.

13. Question: There are several quantity discrepancies between the civil Unit Price Schedule and the plans. Below is a list of items about which we have noted a discrepancy.

- a. 12" & 15" RCP quantities differ
- b. 15" HDPE shown on plans but not listed in Bid Schedule
- c. Junction Box (C3) shown on plans but not listed in Bid Schedule
- d. 4" PVC SDR 26 sanitary sewer pipe shown on plans but 6" PVC SDR 26 listed in Bid Schedule
- e. Curb Taper and Stand Up Curbs shown on plans but not listed on Bid Schedule
- f. Quantities on Paving differ (per Paving Contractor)

Response: The Unit Price Schedule for Sitework has been revised to address the above quantity discrepancies with the plans. There is not a separate line item for the curb tapers. These are included in the linear foot quantities for the corresponding curb type.

Attachments:

1. Unit Price Schedule for Sitework
2. Revised Plan Sheets
3. 10th Avenue Existing Utilities Sheet (For Information Purposes Only)
4. Supplemental Drawing SD-2
5. Supplemental Drawing SD-3
6. Supplemental Drawing SD-4

END OF ADDENDUM NO. 4



City of Tuscaloosa
The EDGE Business Resource Center
Sitework Unit Price Schedule

March 21, 2017

PREPARED BY: BURK-KLEINPETER, INC.

ITEM NO.	APPROX. QTY.	UNIT	ITEM DESCRIPTION	UNIT PRICE	AMOUNT
BASE BID ITEMS					
General, Demolition, Clearing, Grubbing, and Earthwork					
1	1	LS	Demolition, Clearing & Grubbing (Approx. 5 Acres)		
2	650	LF	Remove Existing Piping		
3	4	Each	Remove Existing Storm/Sanitary Structure		
4	2	Each	Plug & Abandon Existing Pipe		
5	1,800	LF	Remove Existing Fence		
6	5,155	SY	Remove Existing Pavements (Asphalt & Concrete)		
7	1	LS	Earthwork		
8	11,500	CYIP	Removal of Unsuitable Material (Only as Directed by the Owner's Representative)		
9	11,500	CYIP	Off-Site Borrow - Select for Unsuitable Material Replacement		
Base, Pavement, and Curb and Gutter Improvements					
10	4,600	SY	Roadbed Processing (Only as Directed by the Owner's Representative)		
11	1,240	SY	Crushed Aggregate Base Course, ALDOT 825B, Plant Mixed, 4" Compacted Thickness		
12	4,290	SY	Crushed Aggregate Base Course, ALDOT 825B, Plant Mixed, 6" Compacted Thickness		
13	4,600	SY	Bituminous Treatment A		
14	385	Gal	Tack Coat		
15	620	SY	Milling Existing Pavement		
16	240	Ton	Superpave Bituminous Concrete Wearing Surface Layer, 1/2" Maximum Aggregate Size Mix, ESAL Range A/B		
17	425	Ton	Superpave Bituminous Concrete Upper Binder Layer, 1" Maximum Aggregate Size Mix, ESAL Range A/B		
18	1,235	SY	Concrete Pavement, 6" Thick Installed		
19	2,350	LF	Type C Combination Curb & Gutter (1.5' Width) Installed		
20	665	LF	Type C Combination Curb & Gutter (2' Width) Installed		
21	120	LF	Valley Gutter Installed		
22	1,310	SY	Concrete Sidewalk, 4" Thick w/ Stone Installed		
23	5	Each	Truncated Domes Installed		
24	3	Each	Parking Stops		
Storm Drain System Improvements					
25	238	LF	12" PVC Storm Pipe, SDR 26 Installed		
26	336	LF	15" HDPE, N-12 Installed		
27	360	LF	15" R.C. Pipe, Class 3 Installed		
28	957	LF	18" R.C. Pipe, Class 3 Installed		
29	1	Each	Junction Box Installed		
30	4	Each	S-Inlet (1-Wing) Installed		

ITEM NO.	APPROX. QTY.	UNIT	ITEM DESCRIPTION	UNIT PRICE	AMOUNT
31	1	Each	S-Inlet (2-Wing) Installed		
32	4	Each	Yard Inlet Installed		
33	4	Each	24" Drain Basin and Grate Installed		
34	1	Each	24" Drain Basin and Solid Cover Installed		
35	3	Each	Slope Paved Headwall Installed		
Sanitary Sewer System Improvements					
36	190	LF	4" PVC Pipe, SDR 26, Sanitary Sewer Lateral Installed		
37	1	Each	8" X 4" Sanitary Sewer Wye (Tie to Existing Main) Installed		
38	2	Each	Sanitary Sewer Cleanout w/ Required Wyes Installed		
Water System Improvements					
39	188	LF	2" PVC Pipe, Class 200, Water Service Line Installed		
40	76	LF	6" DI Class 350 Water Main Installed		
41	1	Each	2" Watermain Service Tap Installed		
42	1	Each	6" Hot Tap w/ 4" Tapping Valve & Sleeve Installed		
43	1	Each	6" Hot Tap w/ 6" Tapping Valve & Sleeve Installed		
44	1	Each	1-1/2" Domestic Meter, Backflow Preventer & Meter Box Installed		
45	1	Each	2" Irrigation Meter, Backflow Preventer & Meter Box Installed		
46	1	Each	6" Double Check Detector Assembly & Vault Installed		
47	1	Each	Siamese Post Connection & Vault Installed		
Traffic Control, Permanent Signing and Striping					
48	1	LS	Traffic Control		
49	1,332	LF	Solid White, Class 1, Type B Traffic Stripe (4" Wide) Installed		
50	234	LF	Solid Blue, Class 1, Type B Traffic Stripe (4" Wide) Installed		
51	4	Each	Handicap Symbols (Traffic Control Markings, Class 1, Type B) Installed		
52	155	LF	Solid White Traffic Control Markings, Class 1, Type B (6" Wide) Installed		
53	29	LF	2' Wide Stop Bar (Traffic Control Markings, Class 1, Type B) Installed		
54	6	Each	Permanent Post Mounted Signs		
Erosion Control and Site Maintenance					
55	1	LS	Erosion Control Management and Maintenance		
Miscellaneous Items					
56	500	Ton	ALDOT No. 57 Stone (Only as Directed by the Owner's Representative)		
57	700	CY	Utility Trench Foundation Material (ALDOT No. 2 Stone) (Only as Directed by the Owner's Representative)		
58	6,700	SY	Geotextile Separation Fabric (Miraf, HP570 or Approved Equal)(Only as Directed by the Owner's Representative) Installed		
ALTERNATE BID ITEMS					
100	45	LF	Standup Curb		

Note:

Unit prices shall be compensation in full for furnishing all materials, equipment, tools, labor and incidentals necessary to complete the work. No extra payment will be made for items not specifically called out in a line item on the Unit Price Schedule such as site preparation, saw-cutting, trench excavation, pipe bedding, trench backfill (including stone), asphalt patching for utility trenches, etc. and the cost of these items shall be included in the appropriate unit price listed in the Schedule.



REVISIONS	DATE	BY	REASON

BK BURK-KLEINPETER, INC.
 ARCHITECT, ENGINEER, PLANNER, ENVIRONMENTAL, INTERIOR

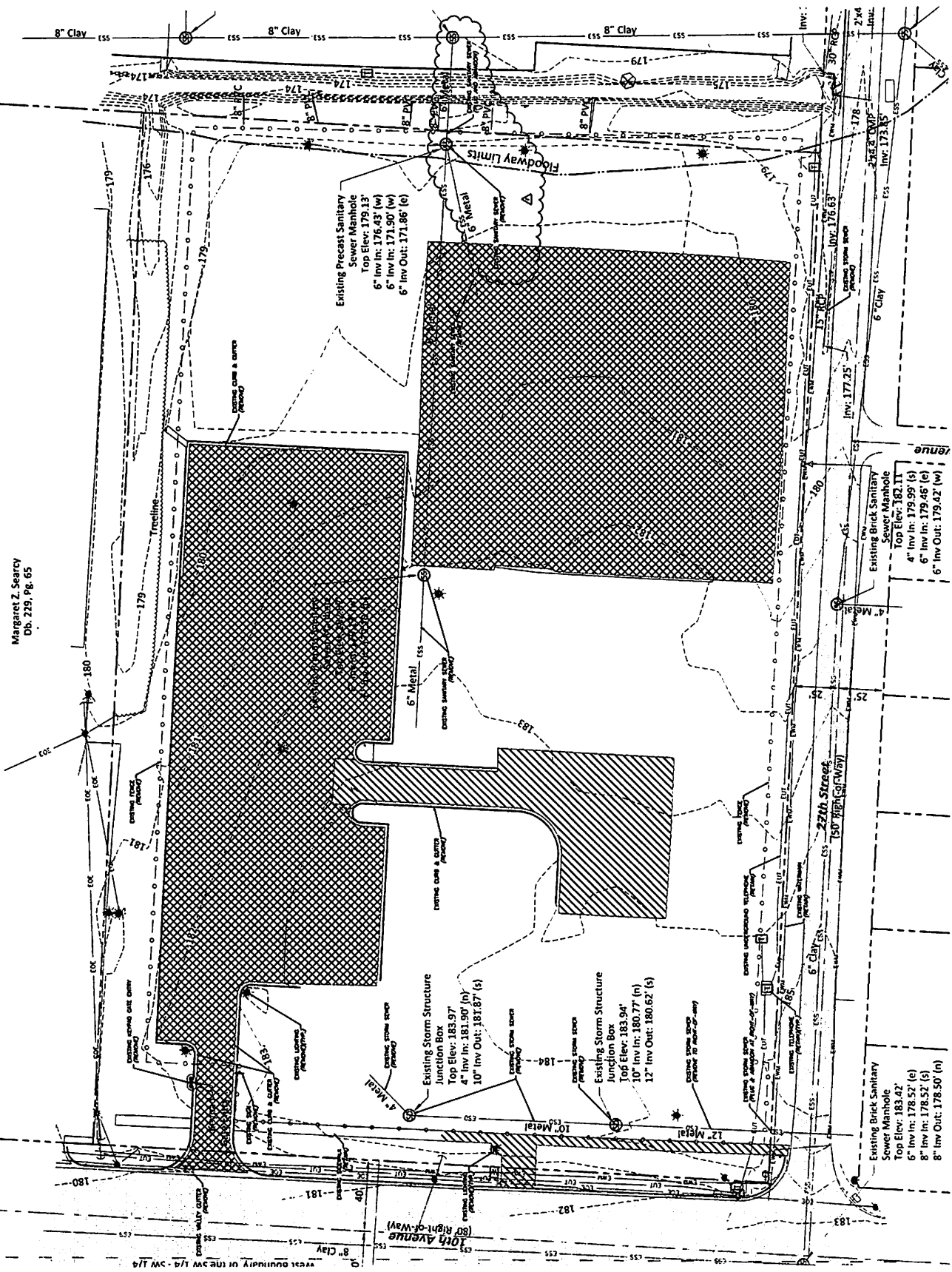

Margaret Z. Searey
 DB: 2229, Pg: 65

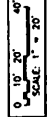

WEST BOUNDARY OF THE SW 1/4 - SW 1/4



Margaret Z. Searcy
Db. 229, Pg. 65

NOTE:
1. SHOULD ARTIFACTS OR ARCHAEOLOGICAL FEATURES BE ENCOUNTERED DURING PROJECT ACTIVITIES,
WORK SHALL CEASE AND EDH AND ALABAMA HISTORICAL COMMISSION SHALL BE CONTACTED IMMEDIATELY.

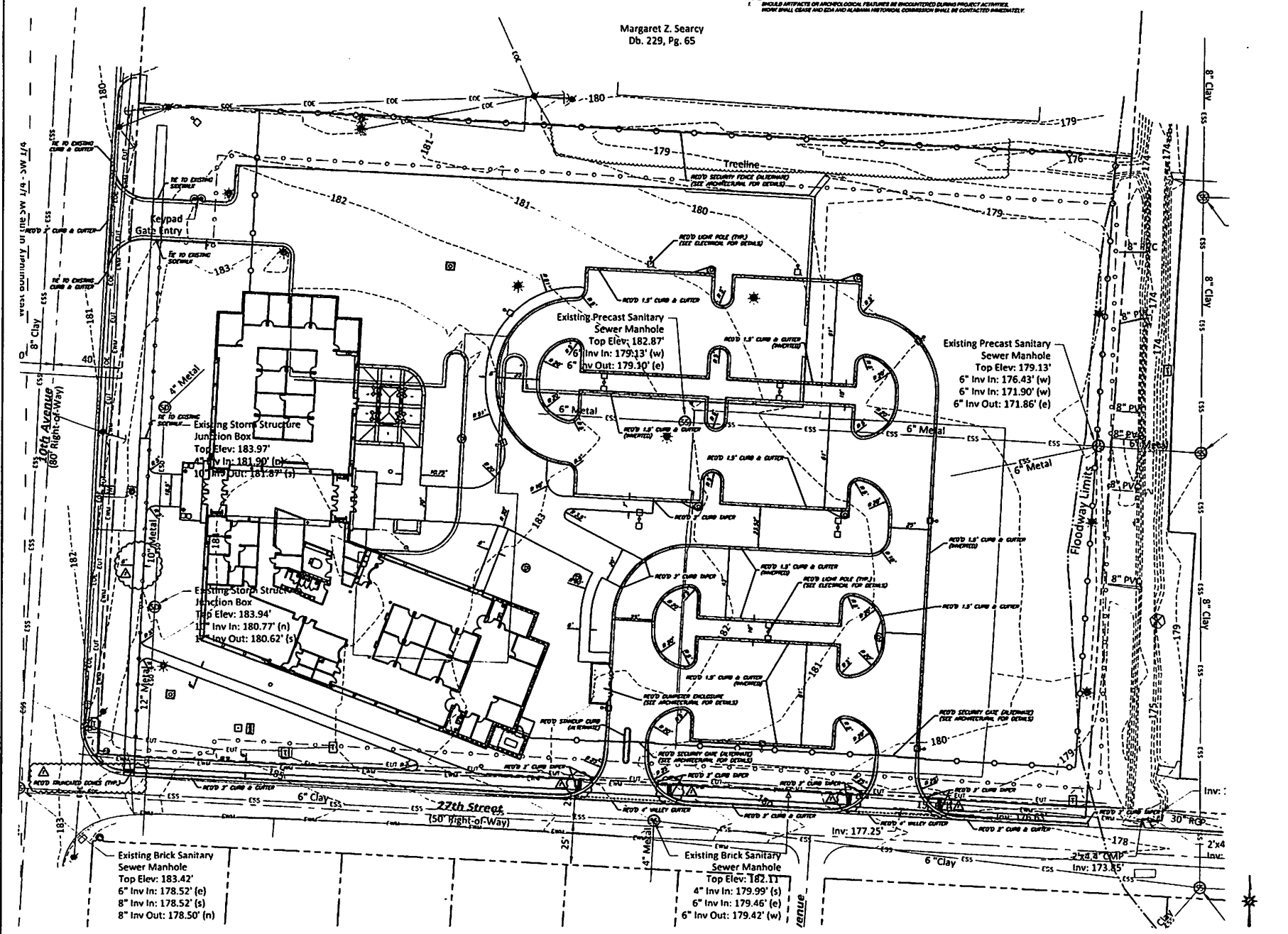

Existing Brick Sanitary
Sewer Manhole
Top Elev: 183.42'
6" Inv In: 178.52' (e)
8" Inv In: 178.52' (s)
8" Inv Out: 178.50' (n)

Existing Brick Sanitary
Sewer Manhole
Top Elev: 182.11'
4" Inv In: 179.99' (s)
6" Inv In: 179.46' (e)
6" Inv Out: 179.42' (w)

Existing Precast Sanitary
Sewer Manhole
Top Elev: 179.13'
6" Inv In: 176.43' (w)
6" Inv In: 171.90' (w)
6" Inv Out: 171.86' (e)

Existing Precast Sanitary
Sewer Manhole
Top Elev: 182.87'
6" Inv In: 179.13' (w)
6" Inv Out: 179.10' (e)

Existing Storm Structure
Junction Box
Top Elev: 183.97'
4" Inv In: 181.90' (n)
10" Inv Out: 181.87' (s)

Existing Storm Structure
Junction Box
Top Elev: 183.94'
4" Inv In: 180.77' (n)
4" Inv Out: 180.62' (s)

THE EDGE BUSINESS RESOURCE CENTER
THE CITY OF TUSCALOOSA
2627 10TH AVENUE, TUSCALOOSA, ALABAMA

SUBMITTAL:
CONSTRUCTION
DOCUMENTS
DATE: 02/05/2016
PROJ NO: 13-073

REVISIONS
A 05/25/18
ADDED SIDEWALK
DIMENSION &
TRUNCATED DOMES

SITE STAKING PLAN

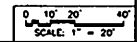

C201



EXISTING LEGEND

- 1. 20' WIDE ASPHALT DRIVEWAY ON 27TH STREET SHALL BE REPLACED BY 20' WIDE ASPHALT DRIVEWAY WITH 2' WIDE SIDEWALK
- 2. 20' WIDE ASPHALT DRIVEWAY ON 27TH STREET SHALL BE REPLACED BY 20' WIDE ASPHALT DRIVEWAY WITH 2' WIDE SIDEWALK
- 3. 20' WIDE ASPHALT DRIVEWAY ON 27TH STREET SHALL BE REPLACED BY 20' WIDE ASPHALT DRIVEWAY WITH 2' WIDE SIDEWALK
- 4. 20' WIDE ASPHALT DRIVEWAY ON 27TH STREET SHALL BE REPLACED BY 20' WIDE ASPHALT DRIVEWAY WITH 2' WIDE SIDEWALK

PAVING CALCULATION

PAVING CALCULATION: 78,548 SF OF DRIVEWAY PAVEMENT, 1,175,200 SF OF DRIVEWAY PAVEMENT, 26,344 SF/200' = 131.72' PAVING SPACES BY PAVING SPACES

PAVING RECOMMENDATIONS

- 1. 20' WIDE ASPHALT DRIVEWAY ON 27TH STREET SHALL BE REPLACED BY 20' WIDE ASPHALT DRIVEWAY WITH 2' WIDE SIDEWALK
- 2. 20' WIDE ASPHALT DRIVEWAY ON 27TH STREET SHALL BE REPLACED BY 20' WIDE ASPHALT DRIVEWAY WITH 2' WIDE SIDEWALK
- 3. 20' WIDE ASPHALT DRIVEWAY ON 27TH STREET SHALL BE REPLACED BY 20' WIDE ASPHALT DRIVEWAY WITH 2' WIDE SIDEWALK
- 4. 20' WIDE ASPHALT DRIVEWAY ON 27TH STREET SHALL BE REPLACED BY 20' WIDE ASPHALT DRIVEWAY WITH 2' WIDE SIDEWALK

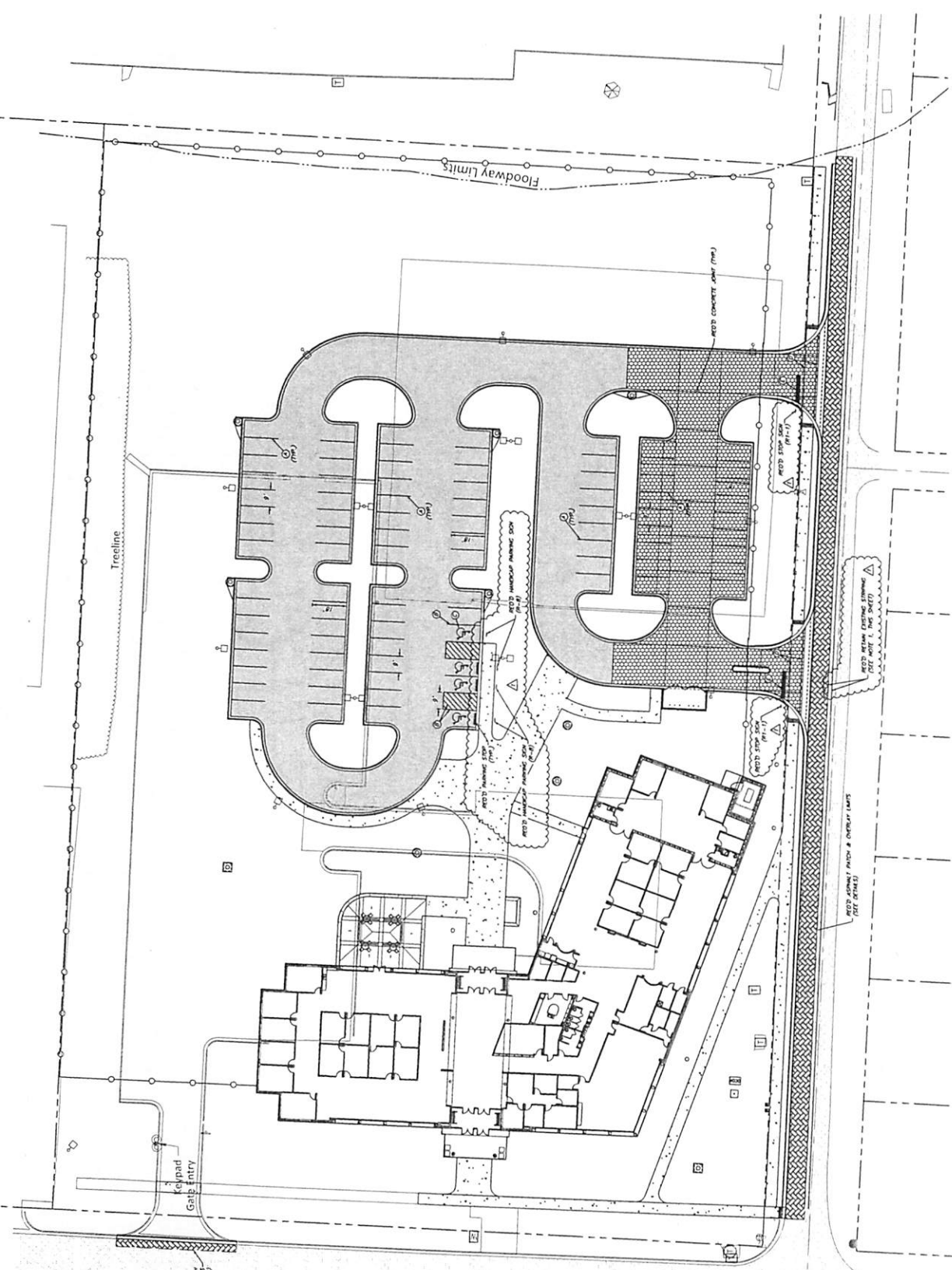

NOTES

1. 20' WIDE ASPHALT DRIVEWAY ON 27TH STREET SHALL BE REPLACED BY 20' WIDE ASPHALT DRIVEWAY WITH 2' WIDE SIDEWALK
2. 20' WIDE ASPHALT DRIVEWAY ON 27TH STREET SHALL BE REPLACED BY 20' WIDE ASPHALT DRIVEWAY WITH 2' WIDE SIDEWALK
3. 20' WIDE ASPHALT DRIVEWAY ON 27TH STREET SHALL BE REPLACED BY 20' WIDE ASPHALT DRIVEWAY WITH 2' WIDE SIDEWALK
4. 20' WIDE ASPHALT DRIVEWAY ON 27TH STREET SHALL BE REPLACED BY 20' WIDE ASPHALT DRIVEWAY WITH 2' WIDE SIDEWALK

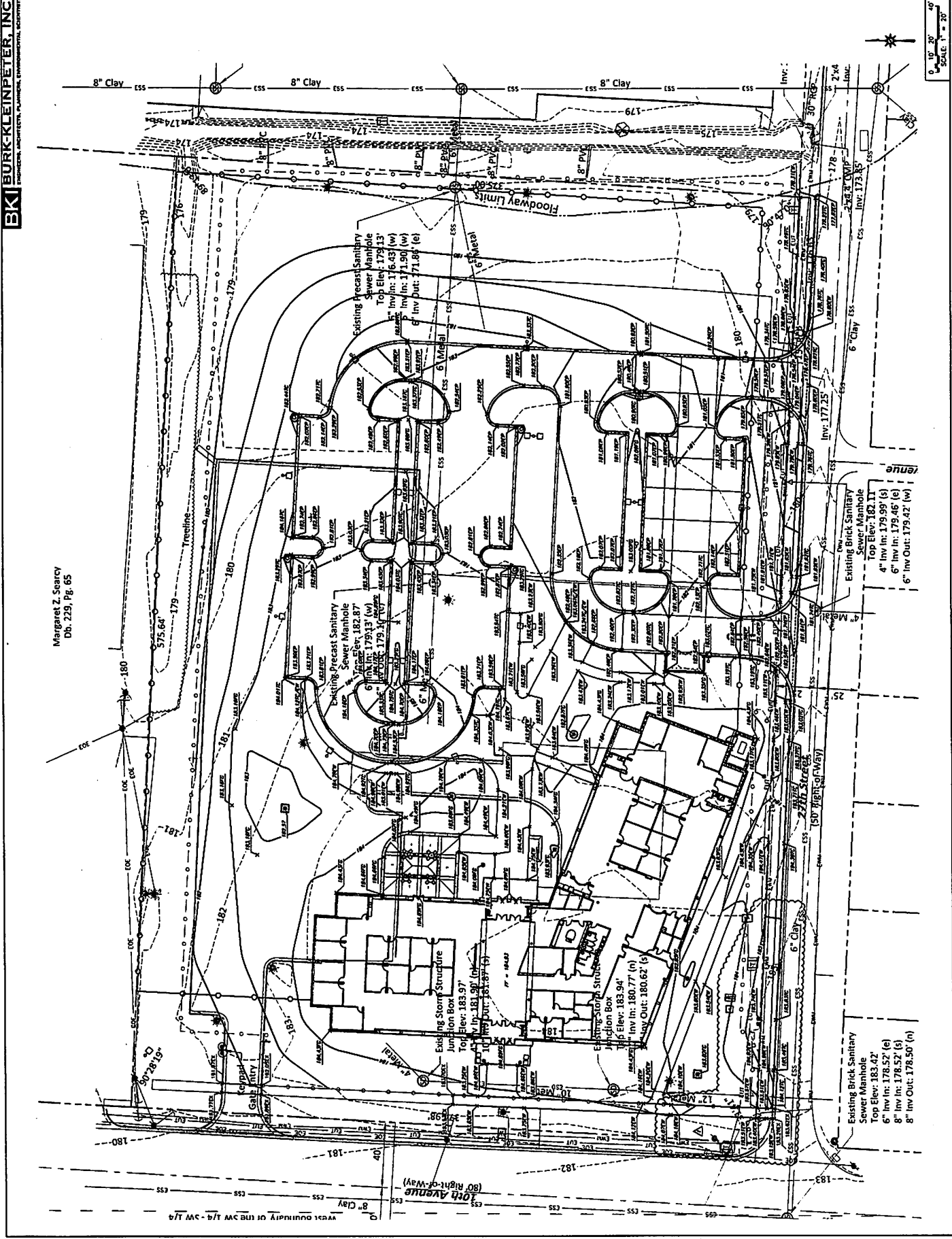

Margaret Z. Searcy
 Db. 229, Pg. 65

BK BURK-KLEINPETER, INC.
 ENGINEERING, ARCHITECTURE, PLANNING, ENVIRONMENTAL, CONSULTING

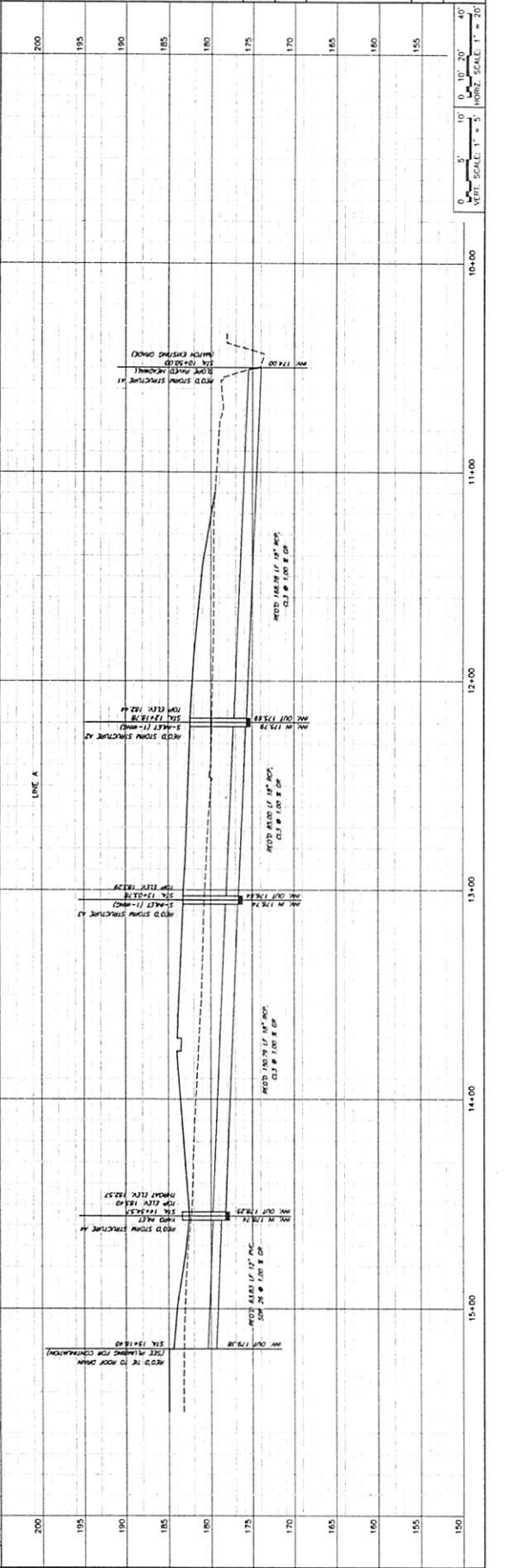
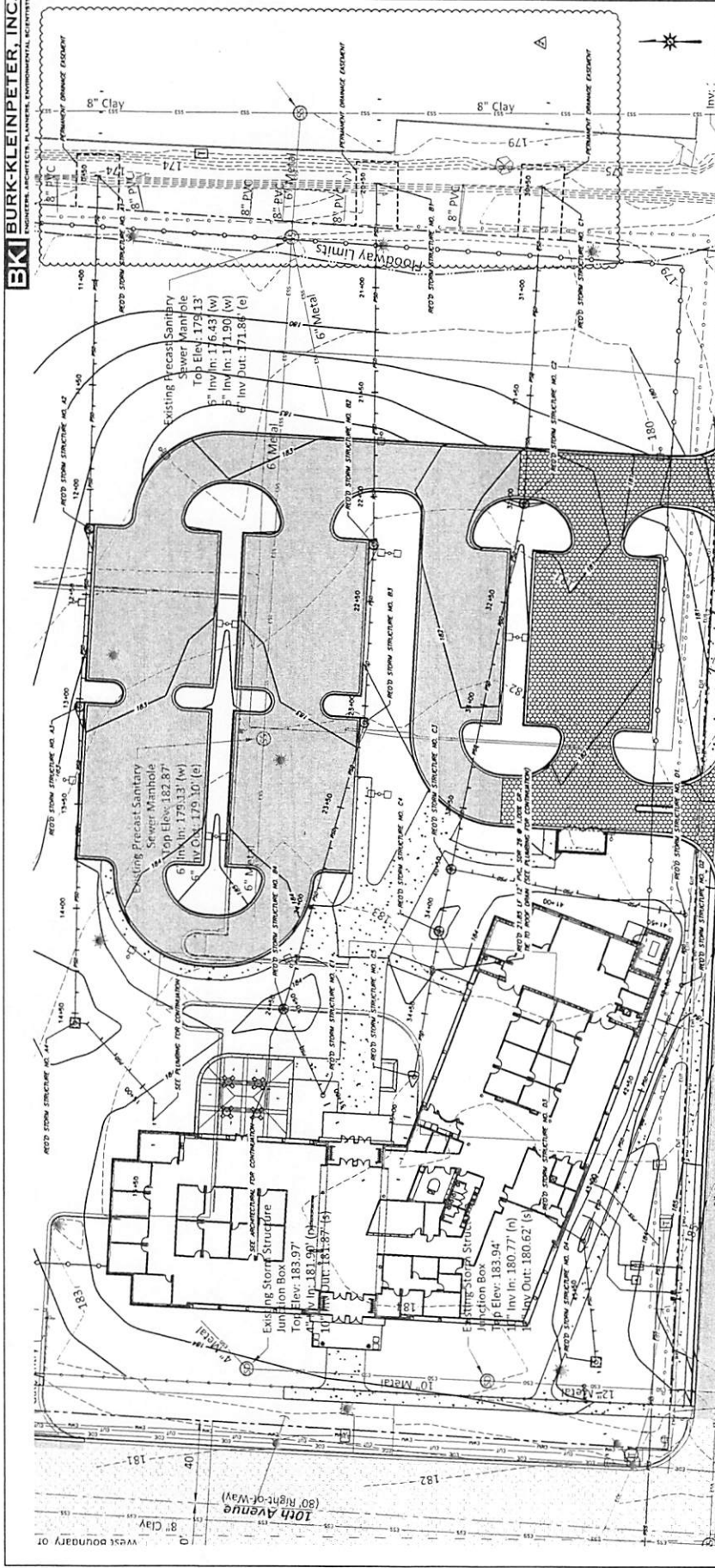

REVISIONS	NO. 1	DATE	06/20/16
NO. 2	DATE	06/20/16	PROJ NO.
NO. 3	DATE	06/20/16	PROJ NO.
NO. 4	DATE	06/20/16	PROJ NO.
NO. 5	DATE	06/20/16	PROJ NO.
NO. 6	DATE	06/20/16	PROJ NO.
NO. 7	DATE	06/20/16	PROJ NO.
NO. 8	DATE	06/20/16	PROJ NO.
NO. 9	DATE	06/20/16	PROJ NO.
NO. 10	DATE	06/20/16	PROJ NO.
NO. 11	DATE	06/20/16	PROJ NO.
NO. 12	DATE	06/20/16	PROJ NO.
NO. 13	DATE	06/20/16	PROJ NO.
NO. 14	DATE	06/20/16	PROJ NO.
NO. 15	DATE	06/20/16	PROJ NO.
NO. 16	DATE	06/20/16	PROJ NO.
NO. 17	DATE	06/20/16	PROJ NO.
NO. 18	DATE	06/20/16	PROJ NO.
NO. 19	DATE	06/20/16	PROJ NO.
NO. 20	DATE	06/20/16	PROJ NO.

C205
 0 5' 10' 20' 40'
 VERT. SCALE: 1" = 3'
 HORIZ. SCALE: 1" = 20'

VEHICLE BOUNDARY OF
S. Clay

10th Avenue
(80' Right-of-Way)

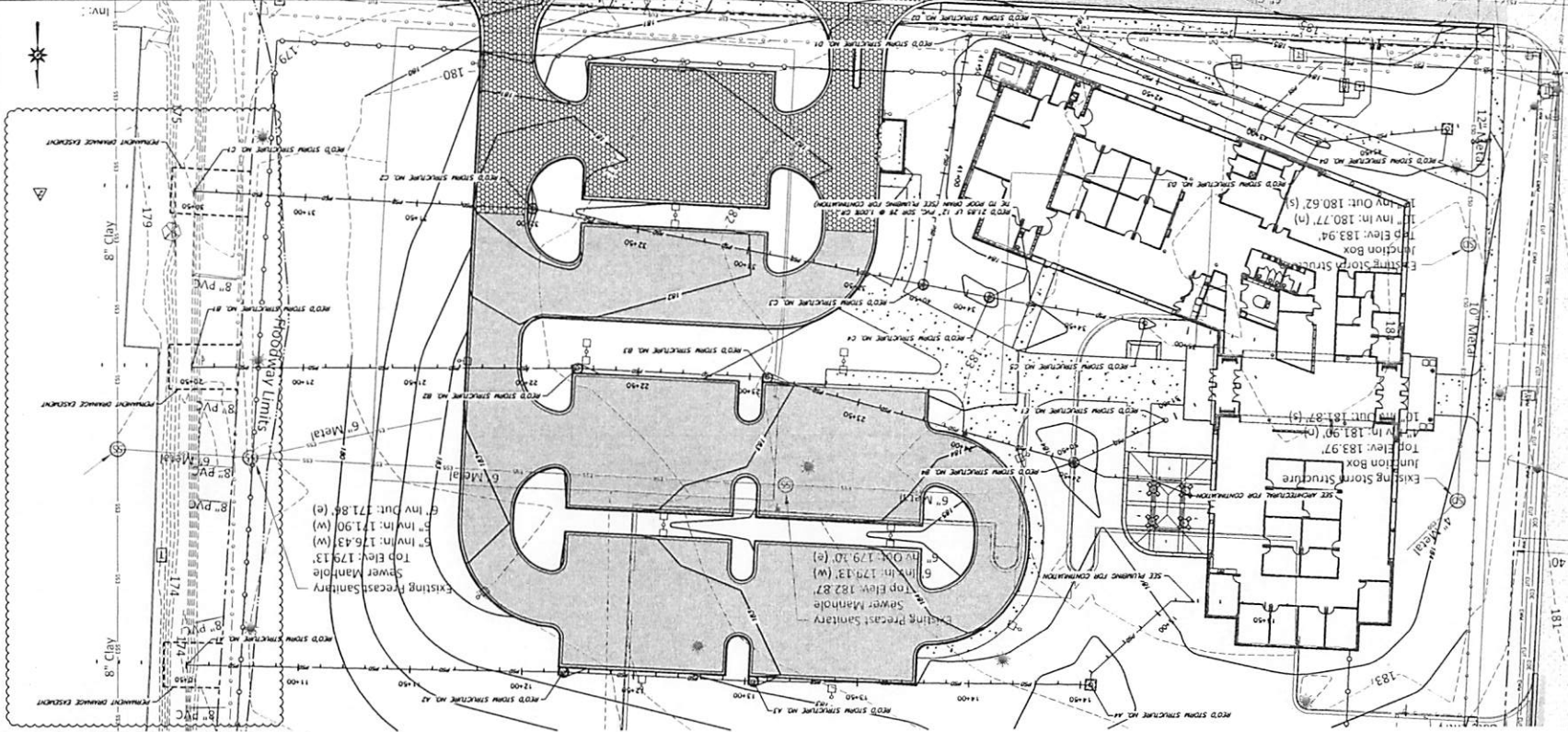

Existing Precast Sanitary Sewer Manhole
Top Elev: 179.13'
5" Inv In: 176.43' (W)
5" Inv In: 171.90' (W)
6" Inv Out: 171.86' (e)

Existing Precast Sanitary Sewer Manhole
Top Elev: 182.87'
6" Inv In: 179.13' (e)
6" Inv In: 179.13' (e)

Existing Precast Sanitary Sewer Manhole
Top Elev: 183.97'
10" Inv In: 181.90' (W)
10" Inv Out: 181.87' (s)

Existing Storm Structure
Top Elev: 183.94'
10" Inv In: 180.77' (n)
10" Inv Out: 180.62' (s)

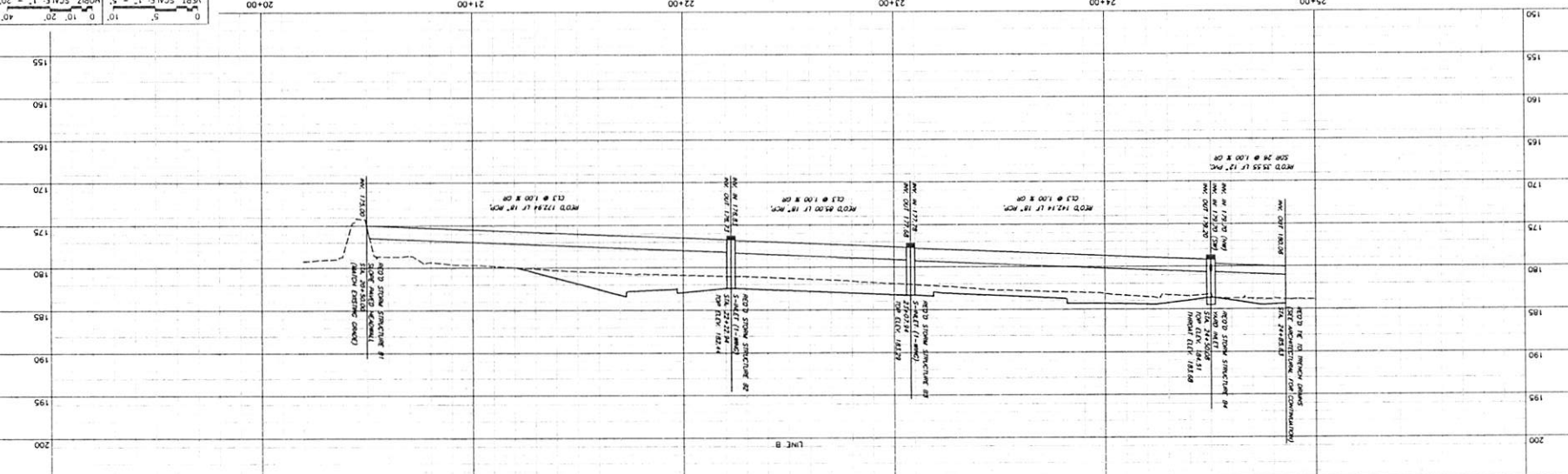

DATE: 05/25/2018
PROJECT NO.: 19-073

REVISIONS

05/25/2018	ADDED TEMPORARY CONSTRUCTION FACILITIES
06/03/2018	CHANGED CHANGE EASEMENTS TO PERMANENT

STATION ESEMENT PLAN A PROJECT - LINE B

THE EDGE BUSINESS RESOURCE CENTER
THE CITY OF TUSCALOOSA
2627 10TH AVENUE, TUSCALOOSA, ALABAMA

WARD SCOTT ARCHITECTURE
2715 Seventh Street
Tuscaloosa, AL 35401
www.ward-scott.com

BKI BURK-KLEINPETER, INC.
ENGINEERS, ARCHITECTS, PLANNERS, ENVIRONMENTAL SCIENTISTS

C206

VERT. SCALE: 1" = 5'
HORIZ. SCALE: 1" = 20'



BKI BURK-KLEMPETER, INC.
 MUNICIPAL ARCHITECTS, PLANNERS, ENVIRONMENTAL SCIENTISTS

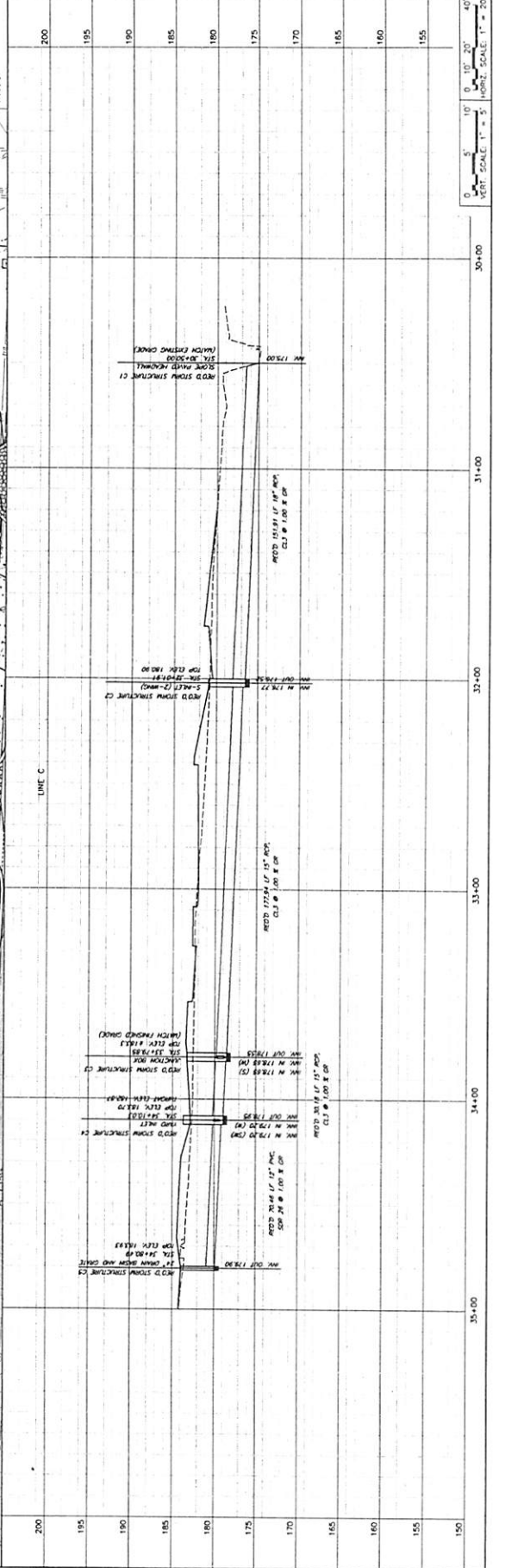
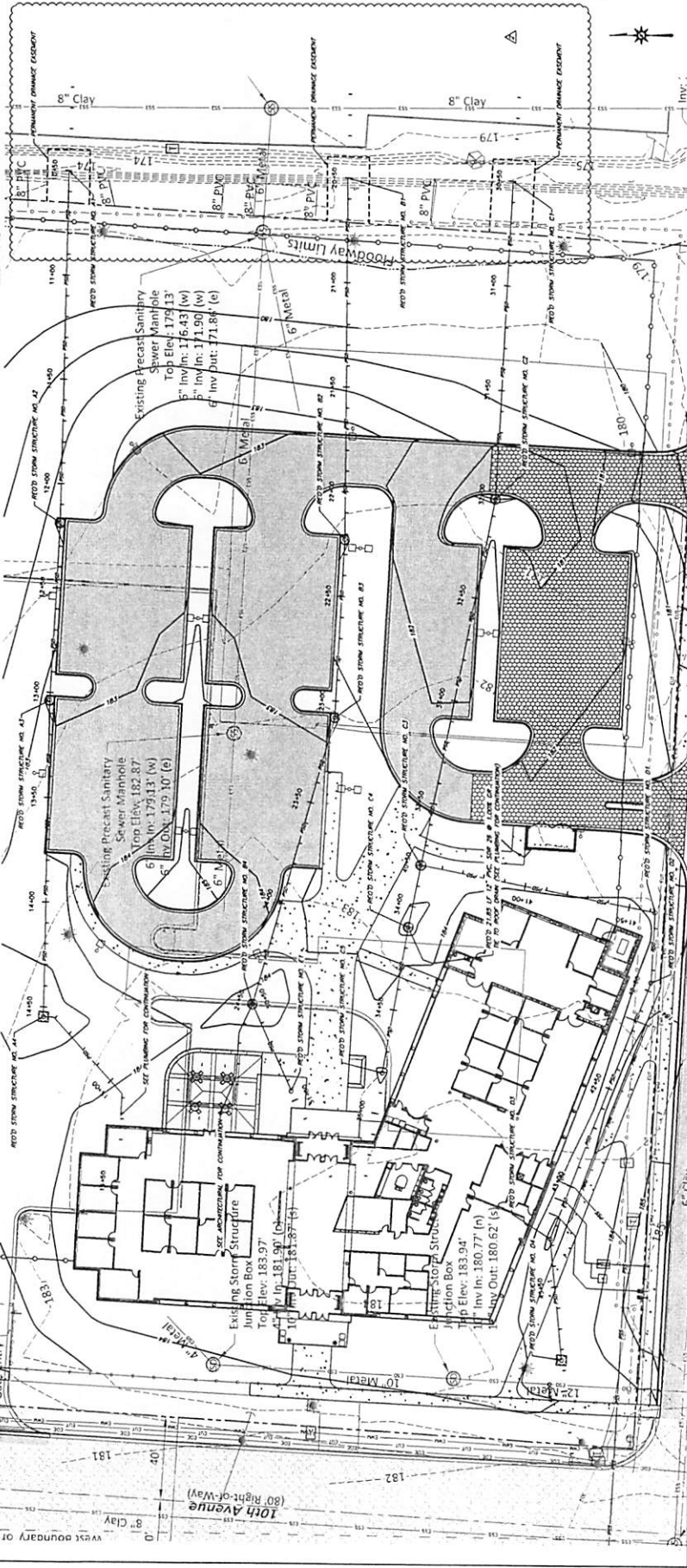

EXISTING UTILITY SHEET

CITY PROJECT NO. A15-021
 SHEET NO. 1 of 1

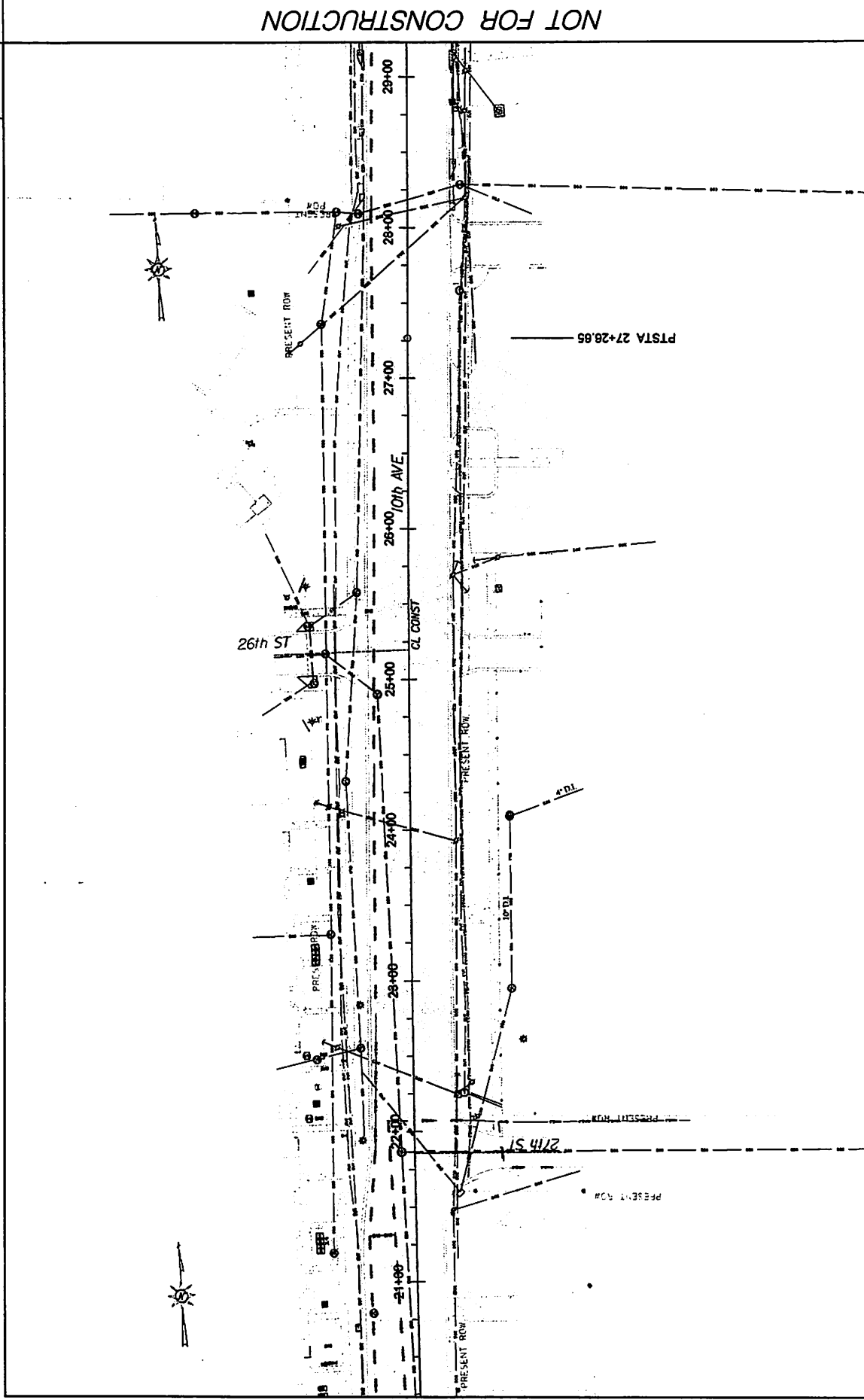

NOT FOR CONSTRUCTION

	10th Avenue Roadway Improvements	City of TUSCALOOSA	HORIZ SCALE (FEET)	SHEET TITLE EXISTING UTILITY SHEET	ROUTE 10th AVENUE
				0 20 30	

REQ'D 24" WIDE CAST IN PLACE TUNCATED DOME TACTILE DETECTABLE WARNING SURFACE BY ARMOR-TILE OR APPROVED EQUAL, BRICK RED

REQ'D CONCRETE SIDEWALK

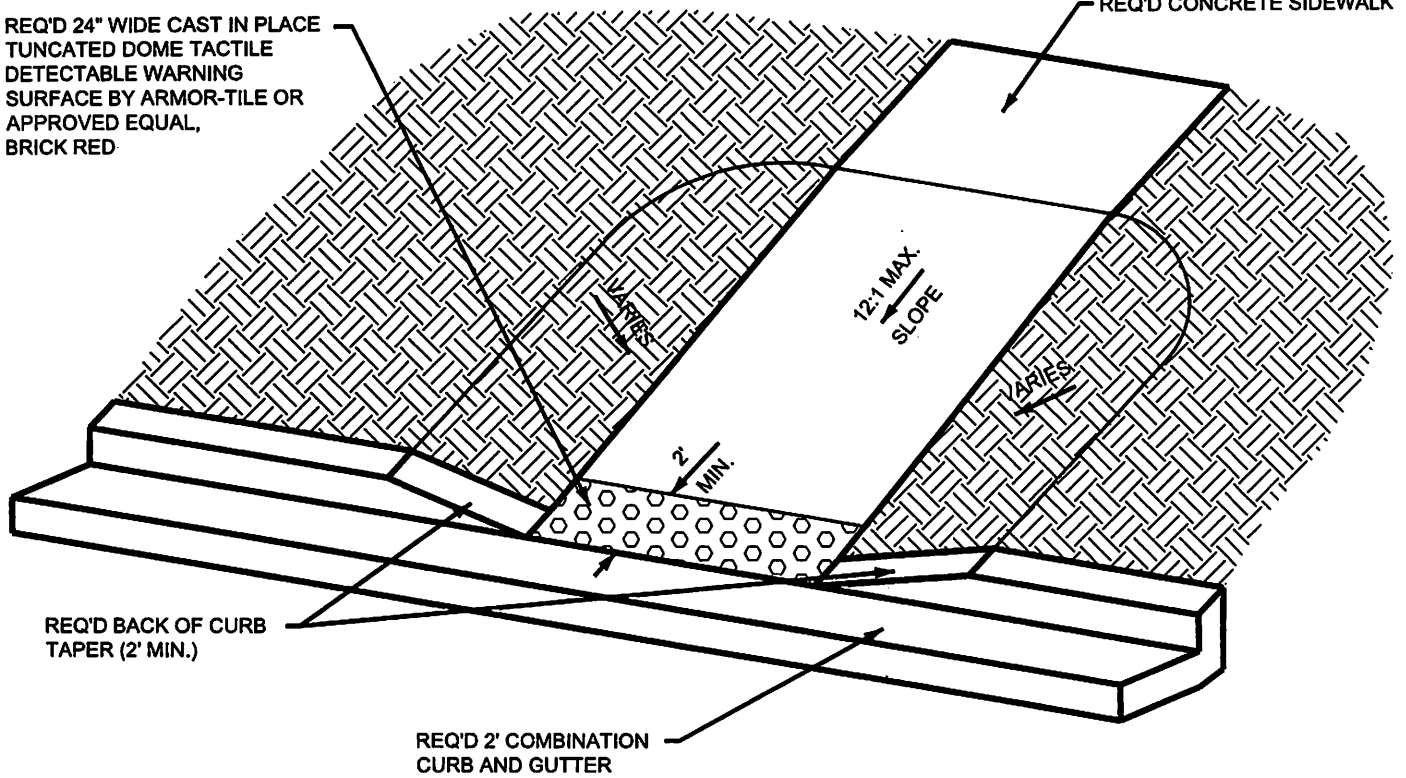

REQ'D BACK OF CURB TAPER (2' MIN.)

REQ'D 2' COMBINATION CURB AND GUTTER

NOTE:

1. LENGTH OF THE "12:1 MAX. SLOPE" SIDEWALK SECTION DEPENDS ON THE HEIGHT OF CURBING AND/OR REQUIRED GRADING. REFER TO GRADING PLAN(S) FOR ADDITIONAL INFORMATION.

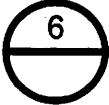

SIDEWALK AT CURB INTERSECTION DETAIL

NOT TO SCALE

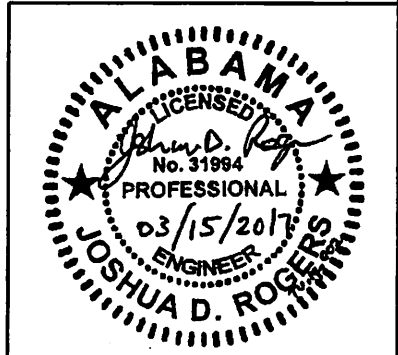

APPROVED BY



THE EDGE BUSINESS RESOURCE CENTER
 THE CITY OF TUSCALOOSA
 SUPPLEMENTAL DRAWING NO. 2
 2627 10TH AVENUE
 TUSCALOOSA, ALABAMA

Proj. No.: 13-073
 DATE: 03/15/2017
 SHEET:

SD-2

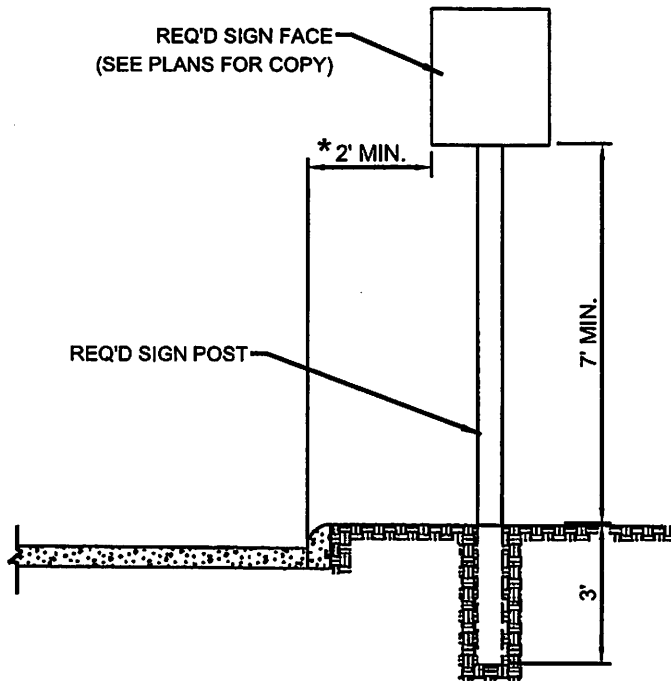

NOTES:

1. SIGNS INSTALLED SHALL MEET ALL REQUIREMENTS OF THE "MANUAL ON UNIFORM CONTROL DEVICES".
2. SIGN POST SHALL BE SINGLE "U" CHANNEL STEEL OR ALUMINUM POSTS MEETING THE REQUIREMENTS OF SECTION 880.04 OF THE ALABAMA DEPARTMENT OF TRANSPORTATION STANDARD SPECIFICATIONS FOR HIGHWAY CONSTRUCTION, LATEST EDITION.
- * 3. WHEN INSTALLING PARKING SIGNS WHICH FACE THE BACK OF CURB, THE FACE OF THE SIGN SHALL BE 2' MINIMUM FROM THE FACE OF THE CURB.

7
POST MOUNTED SIGN DETAIL
 NOT TO SCALE

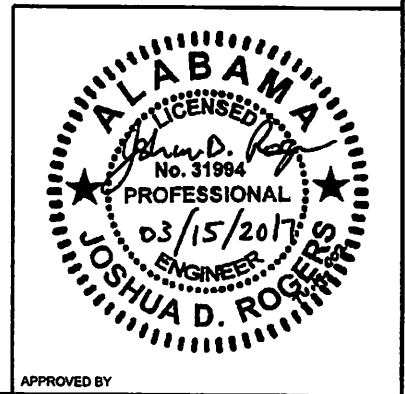

APPROVED BY



THE EDGE BUSINESS RESOURCE CENTER
THE CITY OF TUSCALOOSA
SUPPLEMENTAL DRAWING NO. 3
 2627 10TH AVENUE
 TUSCALOOSA, ALABAMA

Proj. No.: 13-073
 DATE: 03/15/2017
 SHEET:

SD-3

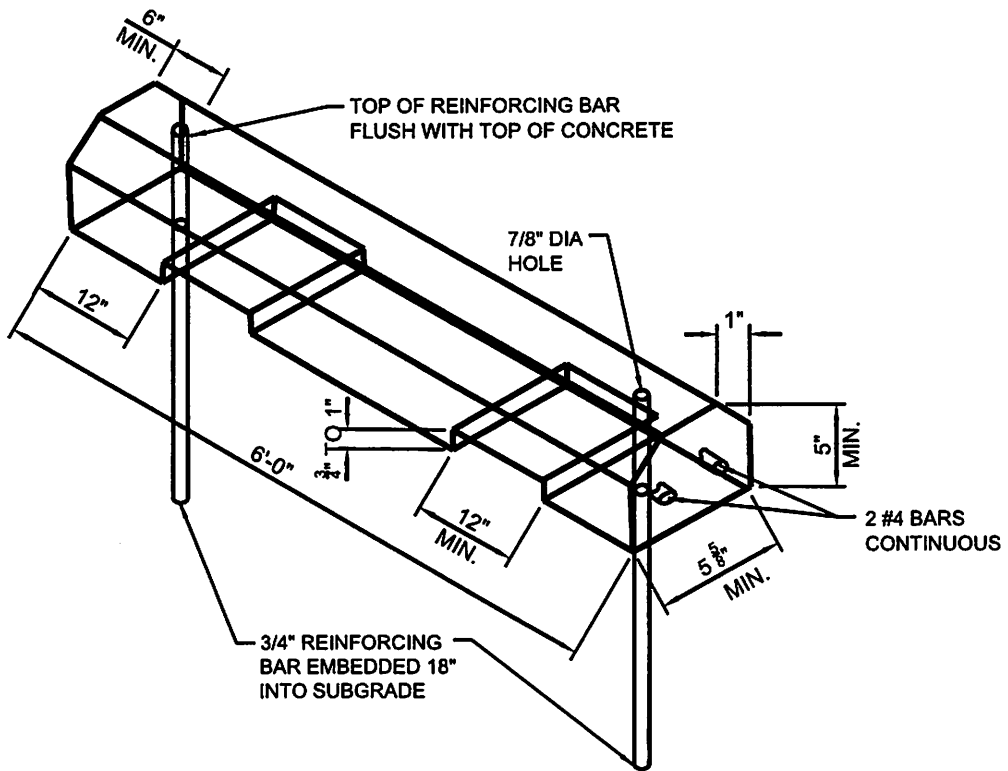

8 PRECAST CONCRETE PARKING STOP
NOT TO SCALE

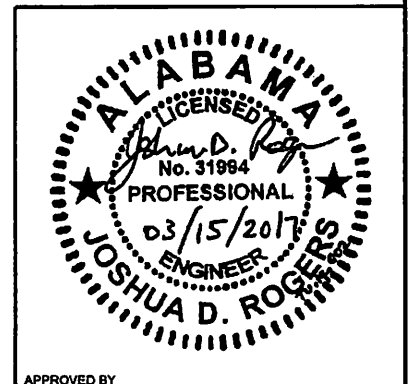

APPROVED BY



THE EDGE BUSINESS RESOURCE CENTER
THE CITY OF TUSCALOOSA
SUPPLEMENTAL DRAWING NO. 4
2627 10TH AVENUE
TUSCALOOSA, ALABAMA

Proj. No.: 13-073
DATE: 03/15/2017
SHEET:

SD-4

ADDENDUM

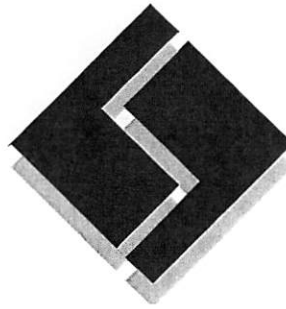

Smith, Stegall & associates p.c.

◆
Consulting Engineers

◆
2110 Eighth Street, Tuscaloosa, AL 35401

◆
Phone/ Fax 205 345 4402

PROJECT: The Edge Business Resource Center	ENG JOB # 1436	DATE: March 21, 2017
--	--------------------------	--------------------------------

ELECTRICAL:

1. Sheet E001:

a. Light Fixture Schedule:

- i. Delete Fixture ZF1.
- ii. The following manufacturers produce products that are acceptable alternates to the luminaires specified.

Luminaire Type	Manufacturer
A	Zaneen, SPI Lighting
B	Rebelle, SPI Lighting
C, CL, CS	Prescolite, Gotham
F	LED Linear, SSL Lighting
GR, GRF, GS, GSH	LiteControl, Arch Lighting Works
H, H2, H3	Hubbell, Skyler Tek
L1, L2, L3	MHT Lighting, Ohyama
M	Winona, SPI Lighting
N	LiteControl, Solera Corp
P	Louis Poulsen, Solera Corp
P2	Winona, LBL Lighting
Q	LiteControl, Arch Lighting Works
R2, R3, R4, R4L, S2,S3,S4,S4L	SPI Lighting, Prudential Lighting
T, T2	Hubbell, Skyler Tek
T3, T4	AAL Lighting, Lumenpulse Group
T5	Kim Lighting, Lumenpulse Group
U	Prescolite, Lighting Services
V3, V4	SPI Lighting, Winona
W4, W6	Lithonia, Columbia
XC, XP, XW	Dual Lite, Light Alarms
Y, Y2, Y3	FC Lighting, Gotham
Z21, Z21L, Z31, Z32	Selux, Beacon Lighting

- b. Riser Diagram: The conduit to the meter should be 1-1/4".
 - c. Electrical Equipment Schedule: Replace as followings:
 - i. Generator to be equal to Generac #SD080, 80KW standby rating, 120/208V, 3 Phase, diesel fueled, 1800 rpm, 120v 1500w coolant heater, mounted residential muffler, batteries, battery charger, 13 hour run time belly tank, aluminum sound attenuated weather protection enclosure, 40A and 200A main line circuit breakers, oil drain extension, remote annunciator panel, vertical air discharge, 2 year standby warranty, all fluids and factory start-up, NFPA 110 compliant.
 - ii. Automomatic Transfer Switches (ATS): 3 pole, open transition, electrically operated, mechanically held, programmable exercise clock, auxilliary contacts, Nema 1 enclosure, Generac 'HT' series. ATS #1: 40A
ATS #2: 200A
 - iii. Equal generator and transfer switches by Taylor Power System, Cummings or Kohler are acceptable.
Taylor Power Systems, Kohler and Generac are acceptable alternates.
 - d. Electrical Symbols: Hubbell is an acceptable floor outlet manufacturer.
- 2. Sheet E100: The riser pole will be located within 50 feet horizontally of the pad mounted transformer.
 - 3. Sheet E201: Add circuit for wall mounted signage just South of front door (10th Ave), circuit B-78 via lighting contactor LC.

END OF ADDENDUM

SIGNATURE: _____	COPY TO: _____
------------------	----------------



HATTAWAY BROTHERS, INC.

REQUEST FOR INFORMATION

Date: 3-15-2017

TO: Jared Gray

FROM: DREW HATTAWAY

CC:

SUBJECT: Edge Resource Center

ELECTRICAL RFI # 1

Sheet e101 note 2 indicates safety switches internal supplied with RTU, all remaining safety switches are not listed for size rating for other mechanical equipment. Please clarify sizing recommended

Equal to or greater than the breaker size feeding the circuit.

Randy Smith

3-16-17

P O Box 797 48121 Hwy 17 205-695-9161 Phone, 205-695-9158 Fax



HATTAWAY BROTHERS, INC.

REQUEST FOR INFORMATION

Date: 3-15-2017

TO: JOSH JOHNSON

FROM: DREW HATTAWAY

CC:

SUBJECT: EDGE RESOURCE CENTER

ELECTRICAL RFI #2

FIXTURE SCHEDULE SHOWS TYPE (ZF1) POLE MOUNTED TYPE. SHEET E100 DOES NOT SHOW THIS FIXTURE ON THE ELECTRICAL SITE PLAN. IS THIS FIXTURE TO BE USED AS LISTED?, IF SO WHATS THE LOCATION? PLEASE ADVISE

Site lighting was revised and this pole mounted luminaire was deleted.

Randy Smith

3-16-17

P O Box 797 48121 Hwy 17 205-695-9161 Phone, 205-695-9158 Fax



DOOR FUNCTION	DOOR TYPE	DOOR WIDTH	DOOR HEIGHT	DOOR		DOOR		DOOR		DOOR		FRAME GLAZING	HURDLES	EDGINGS	COMMENTS
				ELEV.	INT.	ELEV.	INT.	ELEV.	INT.	ELEV.	INT.				
11A	GL	3'-0"	7'-0"	ALUM	GL	ALUM	GL	ALUM	GL	ALUM	GL	GL	HW15	D	
11B	GL	3'-0"	7'-0"	ALUM	GL	ALUM	GL	ALUM	GL	ALUM	GL	GL	HW15	D	
11C	GL	3'-0"	7'-0"	ALUM	GL	ALUM	GL	ALUM	GL	ALUM	GL	GL	HW15	D	
11D	GL	3'-0"	7'-0"	ALUM	GL	ALUM	GL	ALUM	GL	ALUM	GL	GL	HW15	D	
11E	GL	3'-0"	7'-0"	ALUM	GL	ALUM	GL	ALUM	GL	ALUM	GL	GL	HW15	D	
11F	GL	3'-0"	7'-0"	ALUM	GL	ALUM	GL	ALUM	GL	ALUM	GL	GL	HW15	D	
11G	GL	3'-0"	7'-0"	ALUM	GL	ALUM	GL	ALUM	GL	ALUM	GL	GL	HW15	D	
11H	GL	3'-0"	7'-0"	ALUM	GL	ALUM	GL	ALUM	GL	ALUM	GL	GL	HW15	D	
11I	GL	3'-0"	7'-0"	ALUM	GL	ALUM	GL	ALUM	GL	ALUM	GL	GL	HW15	D	
11J	GL	3'-0"	7'-0"	ALUM	GL	ALUM	GL	ALUM	GL	ALUM	GL	GL	HW15	D	
11K	GL	3'-0"	7'-0"	ALUM	GL	ALUM	GL	ALUM	GL	ALUM	GL	GL	HW15	D	
11L	GL	3'-0"	7'-0"	ALUM	GL	ALUM	GL	ALUM	GL	ALUM	GL	GL	HW15	D	
11M	GL	3'-0"	7'-0"	ALUM	GL	ALUM	GL	ALUM	GL	ALUM	GL	GL	HW15	D	
11N	GL	3'-0"	7'-0"	ALUM	GL	ALUM	GL	ALUM	GL	ALUM	GL	GL	HW15	D	
11O	GL	3'-0"	7'-0"	ALUM	GL	ALUM	GL	ALUM	GL	ALUM	GL	GL	HW15	D	
11P	GL	3'-0"	7'-0"	ALUM	GL	ALUM	GL	ALUM	GL	ALUM	GL	GL	HW15	D	
11Q	GL	3'-0"	7'-0"	ALUM	GL	ALUM	GL	ALUM	GL	ALUM	GL	GL	HW15	D	
11R	GL	3'-0"	7'-0"	ALUM	GL	ALUM	GL	ALUM	GL	ALUM	GL	GL	HW15	D	
11S	GL	3'-0"	7'-0"	ALUM	GL	ALUM	GL	ALUM	GL	ALUM	GL	GL	HW15	D	
11T	GL	3'-0"	7'-0"	ALUM	GL	ALUM	GL	ALUM	GL	ALUM	GL	GL	HW15	D	
11U	GL	3'-0"	7'-0"	ALUM	GL	ALUM	GL	ALUM	GL	ALUM	GL	GL	HW15	D	
11V	GL	3'-0"	7'-0"	ALUM	GL	ALUM	GL	ALUM	GL	ALUM	GL	GL	HW15	D	
11W	GL	3'-0"	7'-0"	ALUM	GL	ALUM	GL	ALUM	GL	ALUM	GL	GL	HW15	D	
11X	GL	3'-0"	7'-0"	ALUM	GL	ALUM	GL	ALUM	GL	ALUM	GL	GL	HW15	D	
11Y	GL	3'-0"	7'-0"	ALUM	GL	ALUM	GL	ALUM	GL	ALUM	GL	GL	HW15	D	
11Z	GL	3'-0"	7'-0"	ALUM	GL	ALUM	GL	ALUM	GL	ALUM	GL	GL	HW15	D	
12A	GL	3'-0"	7'-0"	ALUM	GL	ALUM	GL	ALUM	GL	ALUM	GL	GL	HW15	D	
12B	GL	3'-0"	7'-0"	ALUM	GL	ALUM	GL	ALUM	GL	ALUM	GL	GL	HW15	D	
12C	GL	3'-0"	7'-0"	ALUM	GL	ALUM	GL	ALUM	GL	ALUM	GL	GL	HW15	D	
12D	GL	3'-0"	7'-0"	ALUM	GL	ALUM	GL	ALUM	GL	ALUM	GL	GL	HW15	D	
12E	GL	3'-0"	7'-0"	ALUM	GL	ALUM	GL	ALUM	GL	ALUM	GL	GL	HW15	D	
12F	GL	3'-0"	7'-0"	ALUM	GL	ALUM	GL	ALUM	GL	ALUM	GL	GL	HW15	D	
12G	GL	3'-0"	7'-0"	ALUM	GL	ALUM	GL	ALUM	GL	ALUM	GL	GL	HW15	D	
12H	GL	3'-0"	7'-0"	ALUM	GL	ALUM	GL	ALUM	GL	ALUM	GL	GL	HW15	D	
12I	GL	3'-0"	7'-0"	ALUM	GL	ALUM	GL	ALUM	GL	ALUM	GL	GL	HW15	D	
12J	GL	3'-0"	7'-0"	ALUM	GL	ALUM	GL	ALUM	GL	ALUM	GL	GL	HW15	D	
12K	GL	3'-0"	7'-0"	ALUM	GL	ALUM	GL	ALUM	GL	ALUM	GL	GL	HW15	D	
12L	GL	3'-0"	7'-0"	ALUM	GL	ALUM	GL	ALUM	GL	ALUM	GL	GL	HW15	D	
12M	GL	3'-0"	7'-0"	ALUM	GL	ALUM	GL	ALUM	GL	ALUM	GL	GL	HW15	D	
12N	GL	3'-0"	7'-0"	ALUM	GL	ALUM	GL	ALUM	GL	ALUM	GL	GL	HW15	D	
12O	GL	3'-0"	7'-0"	ALUM	GL	ALUM	GL	ALUM	GL	ALUM	GL	GL	HW15	D	
12P	GL	3'-0"	7'-0"	ALUM	GL	ALUM	GL	ALUM	GL	ALUM	GL	GL	HW15	D	
12Q	GL	3'-0"	7'-0"	ALUM	GL	ALUM	GL	ALUM	GL	ALUM	GL	GL	HW15	D	
12R	GL	3'-0"	7'-0"	ALUM	GL	ALUM	GL	ALUM	GL	ALUM	GL	GL	HW15	D	
12S	GL	3'-0"	7'-0"	ALUM	GL	ALUM	GL	ALUM	GL	ALUM	GL	GL	HW15	D	
12T	GL	3'-0"	7'-0"	ALUM	GL	ALUM	GL	ALUM	GL	ALUM	GL	GL	HW15	D	
12U	GL	3'-0"	7'-0"	ALUM	GL	ALUM	GL	ALUM	GL	ALUM	GL	GL	HW15	D	
12V	GL	3'-0"	7'-0"	ALUM	GL	ALUM	GL	ALUM	GL	ALUM	GL	GL	HW15	D	
12W	GL	3'-0"	7'-0"	ALUM	GL	ALUM	GL	ALUM	GL	ALUM	GL	GL	HW15	D	
12X	GL	3'-0"	7'-0"	ALUM	GL	ALUM	GL	ALUM	GL	ALUM	GL	GL	HW15	D	
12Y	GL	3'-0"	7'-0"	ALUM	GL	ALUM	GL	ALUM	GL	ALUM	GL	GL	HW15	D	
12Z	GL	3'-0"	7'-0"	ALUM	GL	ALUM	GL	ALUM	GL	ALUM	GL	GL	HW15	D	

GLAZING SCHEDULE

G1: 1/4" CLEAR TEMPERED GLASS
 G2: 1/4" POINTED TEMPERED GLASS
 G3: 1/4" INSULATED GLAZING UNIT WITH WET COOL TYPICAL
 G4: 1/4" INSULATED GLAZING UNIT WITH SEAR COOL TYPICAL
 G5: 1/4" INSULATED ALUMINUM PANEL
 G6: NOT USED
 G7: NOT USED
 G8: FULLY TEMPERED

DOOR FUNCTION	DOOR TYPE	DOOR WIDTH	DOOR HEIGHT	DOOR		DOOR		DOOR		DOOR		FRAME GLAZING	HURDLES	EDGINGS	COMMENTS
				ELEV.	INT.	ELEV.	INT.	ELEV.	INT.	ELEV.	INT.				
13A	GL	3'-0"	7'-0"	ALUM	GL	ALUM	GL	ALUM	GL	ALUM	GL	GL	HW15	D	
13B	GL	3'-0"	7'-0"	ALUM	GL	ALUM	GL	ALUM	GL	ALUM	GL	GL	HW15	D	
13C	GL	3'-0"	7'-0"	ALUM	GL	ALUM	GL	ALUM	GL	ALUM	GL	GL	HW15	D	
13D	GL	3'-0"	7'-0"	ALUM	GL	ALUM	GL	ALUM	GL	ALUM	GL	GL	HW15	D	
13E	GL	3'-0"	7'-0"	ALUM	GL	ALUM	GL	ALUM	GL	ALUM	GL	GL	HW15	D	
13F	GL	3'-0"	7'-0"	ALUM	GL	ALUM	GL	ALUM	GL	ALUM	GL	GL	HW15	D	
13G	GL	3'-0"	7'-0"	ALUM	GL	ALUM	GL	ALUM	GL	ALUM	GL	GL	HW15	D	
13H	GL	3'-0"	7'-0"	ALUM	GL	ALUM	GL	ALUM	GL	ALUM	GL	GL	HW15	D	
13I	GL	3'-0"	7'-0"	ALUM	GL	ALUM	GL	ALUM	GL	ALUM	GL	GL	HW15	D	
13J	GL	3'-0"	7'-0"	ALUM	GL	ALUM	GL	ALUM	GL	ALUM	GL	GL	HW15	D	
13K	GL	3'-0"	7'-0"	ALUM	GL	ALUM	GL	ALUM	GL	ALUM	GL	GL	HW15	D	
13L	GL	3'-0"	7'-0"	ALUM	GL	ALUM	GL	ALUM	GL	ALUM	GL	GL	HW15	D	
13M	GL	3'-0"	7'-0"	ALUM	GL	ALUM	GL	ALUM	GL	ALUM	GL	GL	HW15	D	
13N	GL	3'-0"	7'-0"	ALUM	GL	ALUM	GL	ALUM	GL	ALUM	GL	GL	HW15	D	
13O	GL	3'-0"	7'-0"	ALUM	GL	ALUM	GL	ALUM	GL	ALUM	GL	GL	HW15	D	
13P	GL	3'-0"	7'-0"	ALUM	GL	ALUM	GL	ALUM	GL	ALUM	GL	GL	HW15	D	
13Q	GL	3'-0"	7'-0"	ALUM	GL	ALUM	GL	ALUM	GL	ALUM	GL	GL	HW15	D	
13R	GL	3'-0"	7'-0"	ALUM	GL	ALUM	GL	ALUM	GL	ALUM	GL	GL	HW15	D	
13S	GL	3'-0"	7'-0"	ALUM	GL	ALUM	GL	ALUM	GL	ALUM	GL	GL	HW15	D	
13T	GL	3'-0"	7'-0"	ALUM	GL	ALUM	GL	ALUM	GL	ALUM	GL	GL	HW15	D	
13U	GL	3'-0"	7'-0"	ALUM	GL	ALUM	GL	ALUM	GL	ALUM	GL	GL	HW15	D	
13V	GL	3'-0"	7'-0"	ALUM	GL	ALUM	GL	ALUM	GL	ALUM	GL	GL	HW15	D	
13W	GL	3'-0"	7'-0"	ALUM	GL	ALUM	GL	ALUM	GL	ALUM	GL	GL	HW15	D	
13X	GL	3'-0"	7'-0"	ALUM	GL	ALUM	GL	ALUM	GL	ALUM	GL	GL	HW15	D	
13Y	GL	3'-0"	7'-0"	ALUM	GL	ALUM	GL	ALUM	GL	ALUM	GL	GL	HW15	D	
13Z	GL	3'-0"	7'-0"	ALUM	GL	ALUM	GL	ALUM	GL	ALUM	GL	GL	HW15	D	

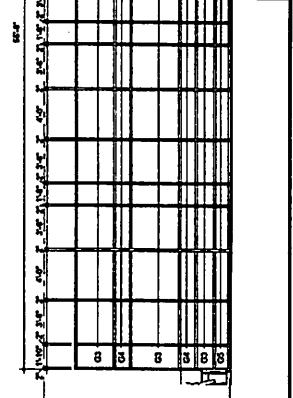
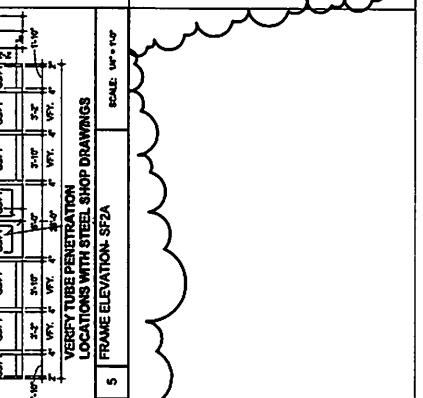
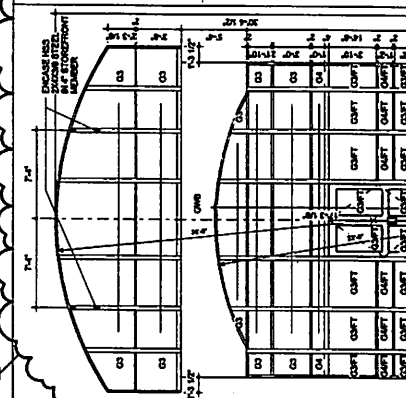
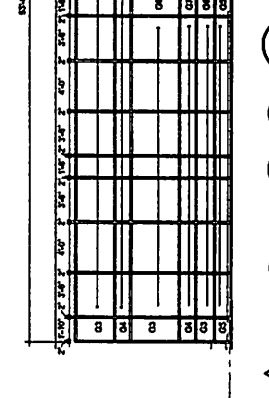
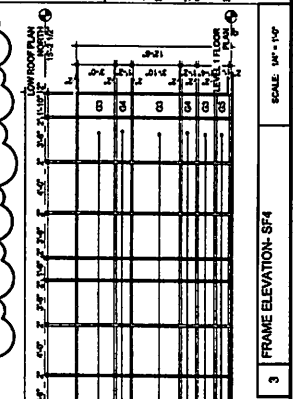
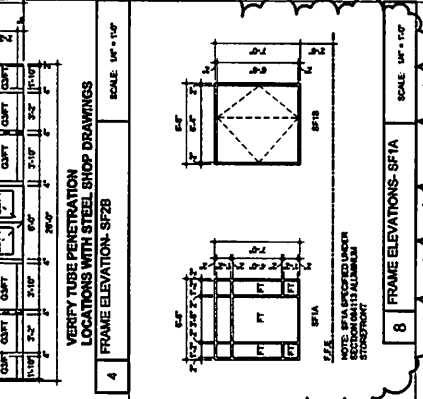
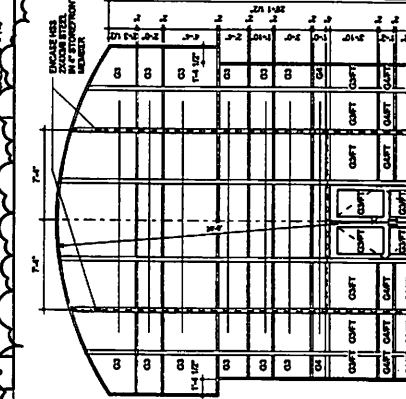
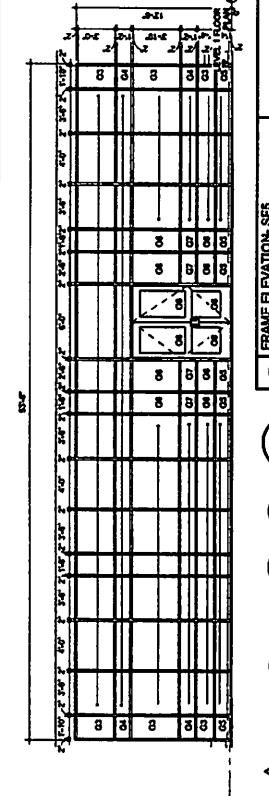

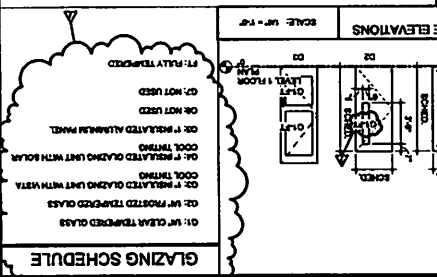
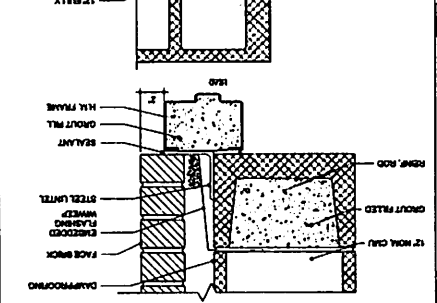
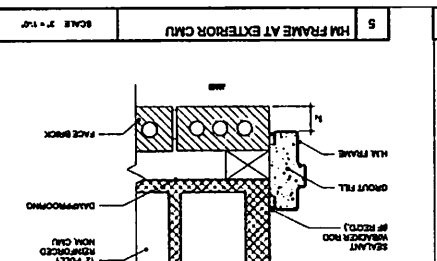
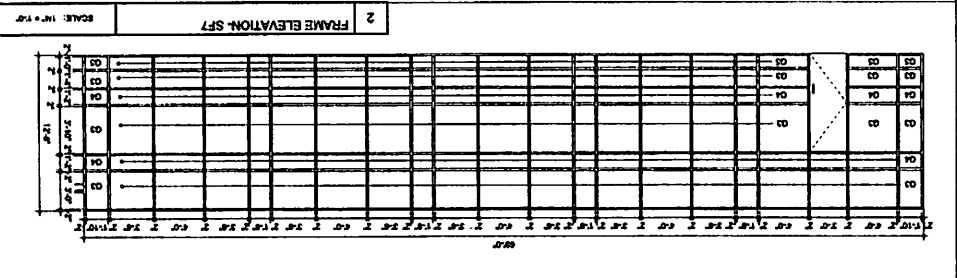
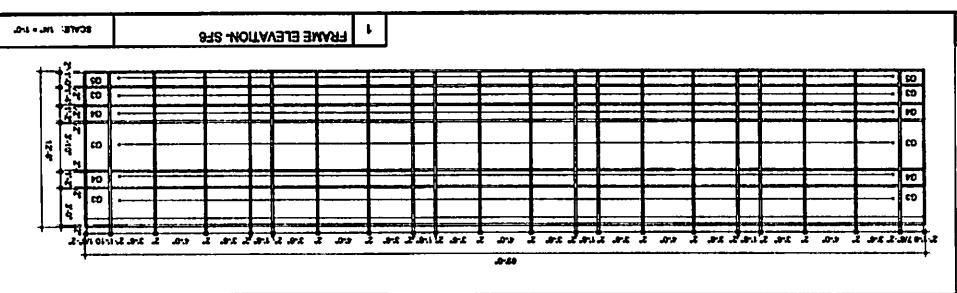
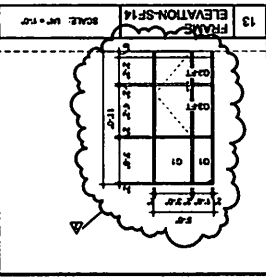
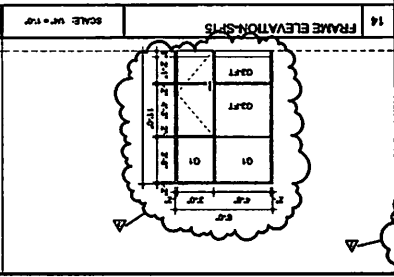
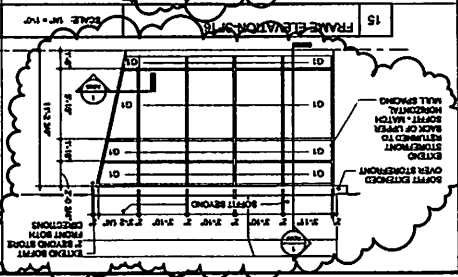
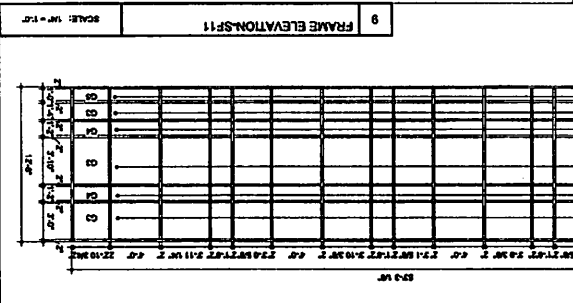
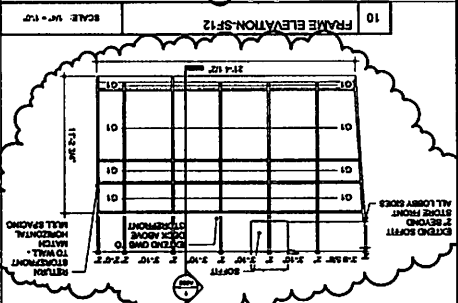
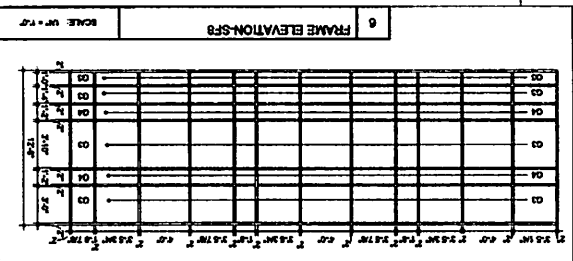
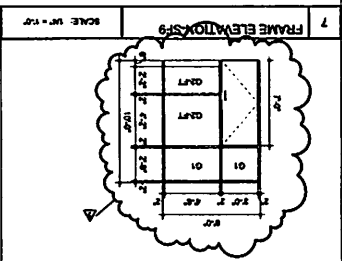
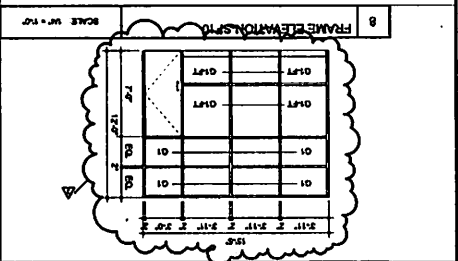
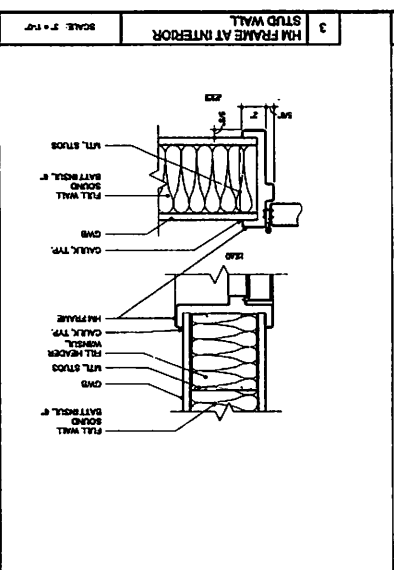
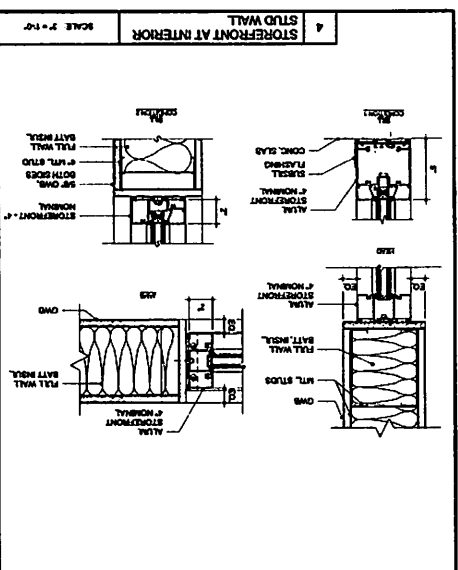

A003

DATE: 7.26.15
PROJECT NO: 15073
CONSTRUCTION DOCUMENTS

REVISIONS
DESC. DATE
BY
APPROVED DATE
BY

OPENING ELEVATION A
DETAILS

THE EDGE BUSINESS RESOURCE CENTER
THE CITY OF TUSCALOOSA
2827 10TH AVENUE
TUSCALOOSA, ALABAMA

WARD SCOTT ARCHITECTURE
2725 UNIVERSITY AVENUE, SUITE 200
TUSCALOOSA, ALABAMA 35404
205.335.1111

GLAZING SCHEDULE

- G1: 1/2" CLEAR TEMPERED GLASS
- G2: 1/2" REFLECTED TEMPERED GLASS
- G3: 1/2" REFLECTED GLAZING UNIT WITH VENT
- G4: 1/2" REFLECTED GLAZING UNIT WITH SOLAR COOL TINTING
- G5: 1/2" REFLECTED ALUMINUM PANEL
- G6: NOT USED
- G7: FULLY TEMPERED

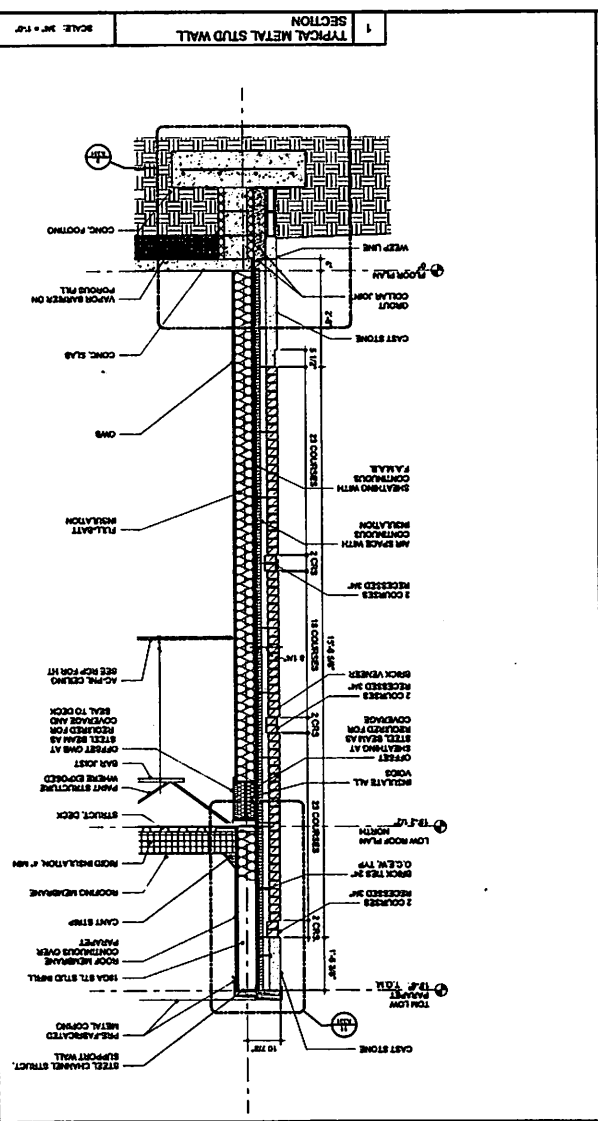
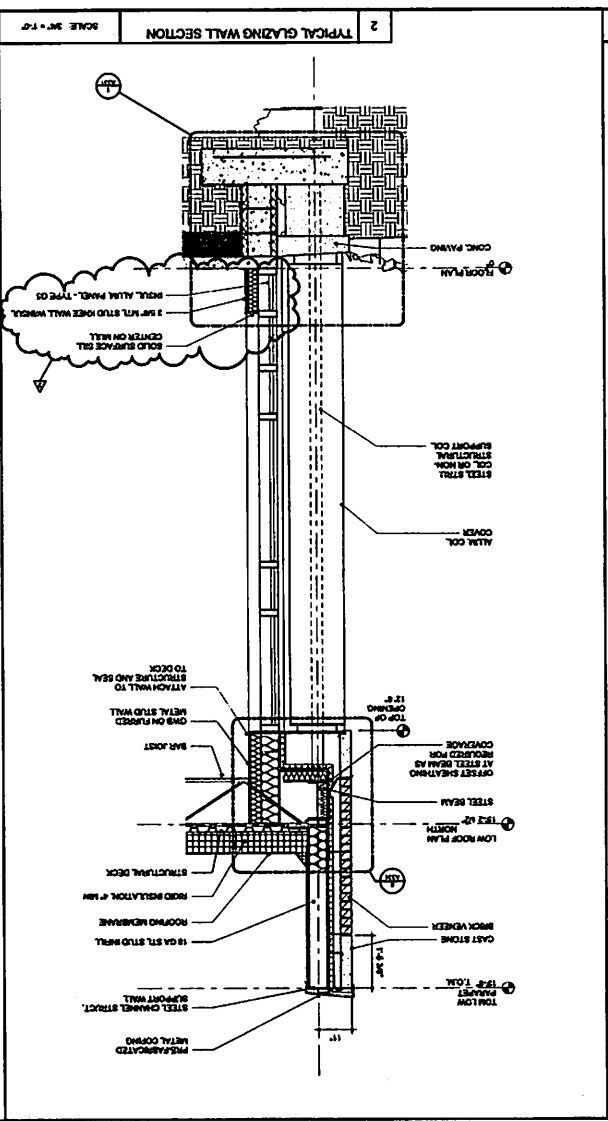
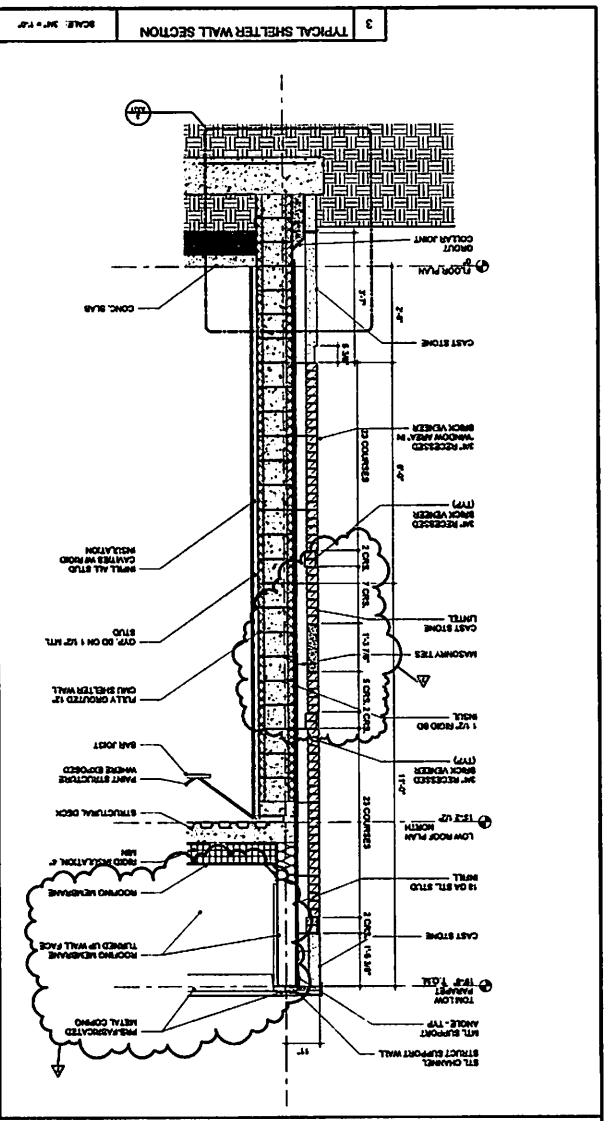

DATE: 10-18	PROJECT NO.: 10-07	CONSTRUCTION DOCUMENTS
REV. 1 DATE	DESCRIPTION	
REV. 2 DATE	DESCRIPTION	
REV. 3 DATE	DESCRIPTION	
REV. 4 DATE	DESCRIPTION	
REV. 5 DATE	DESCRIPTION	
REV. 6 DATE	DESCRIPTION	
REV. 7 DATE	DESCRIPTION	
REV. 8 DATE	DESCRIPTION	
REV. 9 DATE	DESCRIPTION	
REV. 10 DATE	DESCRIPTION	
REV. 11 DATE	DESCRIPTION	
REV. 12 DATE	DESCRIPTION	
REV. 13 DATE	DESCRIPTION	
REV. 14 DATE	DESCRIPTION	
REV. 15 DATE	DESCRIPTION	
REV. 16 DATE	DESCRIPTION	
REV. 17 DATE	DESCRIPTION	
REV. 18 DATE	DESCRIPTION	
REV. 19 DATE	DESCRIPTION	
REV. 20 DATE	DESCRIPTION	
REV. 21 DATE	DESCRIPTION	
REV. 22 DATE	DESCRIPTION	
REV. 23 DATE	DESCRIPTION	
REV. 24 DATE	DESCRIPTION	
REV. 25 DATE	DESCRIPTION	
REV. 26 DATE	DESCRIPTION	
REV. 27 DATE	DESCRIPTION	
REV. 28 DATE	DESCRIPTION	
REV. 29 DATE	DESCRIPTION	
REV. 30 DATE	DESCRIPTION	
REV. 31 DATE	DESCRIPTION	
REV. 32 DATE	DESCRIPTION	
REV. 33 DATE	DESCRIPTION	
REV. 34 DATE	DESCRIPTION	
REV. 35 DATE	DESCRIPTION	
REV. 36 DATE	DESCRIPTION	
REV. 37 DATE	DESCRIPTION	
REV. 38 DATE	DESCRIPTION	
REV. 39 DATE	DESCRIPTION	
REV. 40 DATE	DESCRIPTION	
REV. 41 DATE	DESCRIPTION	
REV. 42 DATE	DESCRIPTION	
REV. 43 DATE	DESCRIPTION	
REV. 44 DATE	DESCRIPTION	
REV. 45 DATE	DESCRIPTION	
REV. 46 DATE	DESCRIPTION	
REV. 47 DATE	DESCRIPTION	
REV. 48 DATE	DESCRIPTION	
REV. 49 DATE	DESCRIPTION	
REV. 50 DATE	DESCRIPTION	



THE EDGE BUSINESS RESOURCE CENTER
 THE CITY OF TUSCALOOSA
 2627 10TH AVENUE
 TUSCALOOSA, ALABAMA

2 TYPICAL SHELTER WINDOW SECTION
SCALE: 3/4" = 1'-0"

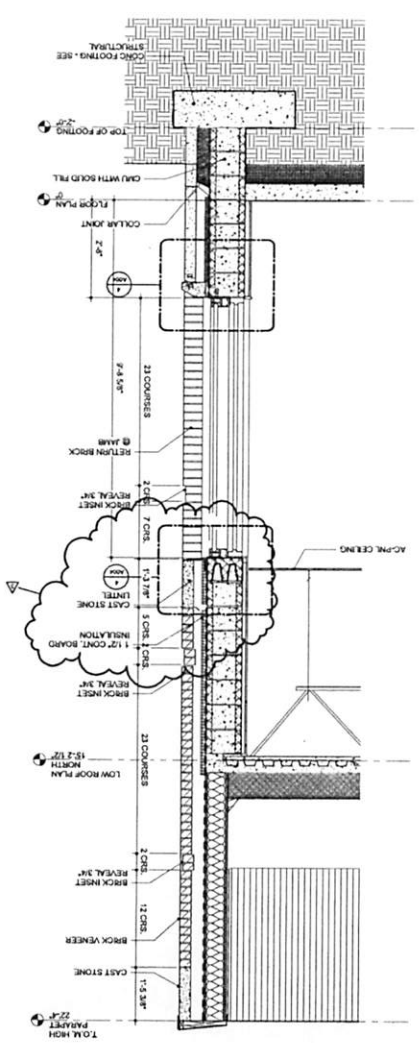

1 HIGH WALL SECTION
SCALE: 3/4" = 1'-0"

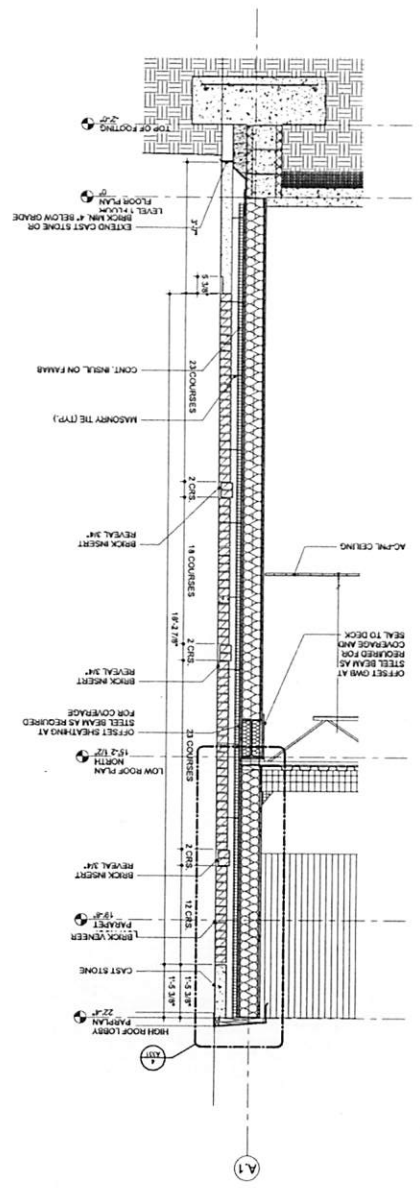

A312

REVISIONS	DATE: 7-25-10	PROJ. NO: 13-073	DOCUMENTS
BY: MRM	DATE: 12/11/11		CONSTRUCTIONS
WALL SECTIONS			

THE EDGE BUSINESS RESOURCE CENTER
THE CITY OF TUSCALOOSA
2627 10TH AVENUE,
TUSCALOOSA, ALABAMA



**WARD
SCOTT**
ARCHITECTURE

2715 Seventh Street
Tuscaloosa, AL 35601
www.ward-scott.com

SECTION 088000 - GLAZING

PART 1 - GENERAL

1.1 RELATED DOCUMENTS

- A. Drawings and general provisions of the Contract, including General and Supplementary Conditions and Division 1 Specification Sections, apply to this Section.

1.2 SUMMARY

- A. This Section includes glazing for the following products and applications, including those specified in other Sections where glazing requirements are specified by reference to this Section:
 - 1. Doors.
 - 2. Glazed entrances.
 - 3. Interior borrowed lites.
 - 4. Storefront framing.

1.3 DEFINITIONS

- A. Manufacturers of Glass Products: Firms that produce primary glass, fabricated glass, or both, as defined in referenced glazing publications.
- B. Glass Thicknesses: Indicated by thickness designations in millimeters according to ASTM C 1036.
- C. Interspace: Space between lites of an insulating-glass unit that contains dehydrated air or a specified gas.
- D. Deterioration of Coated Glass: Defects developed from normal use that are attributed to the manufacturing process and not to causes other than glass breakage and practices for maintaining and cleaning coated glass contrary to manufacturer's written instructions. Defects include peeling, cracking, and other indications of deterioration in metallic coating.
- E. Deterioration of Insulating Glass: Failure of hermetic seal under normal use that is attributed to the manufacturing process and not to causes other than glass breakage and practices for maintaining and cleaning insulating glass contrary to manufacturer's written instructions. Evidence of failure is the obstruction of vision by dust, moisture, or film on interior surfaces of glass.
- F. Deterioration of Laminated Glass: Defects developed from normal use that are attributed to the manufacturing process and not to causes other than glass breakage and practices for maintaining and cleaning laminated glass contrary to manufacturer's written instructions. Defects include edge separation, delamination materially obstructing vision through glass, and blemishes exceeding those allowed by referenced laminated-glass standard.

1.4 PERFORMANCE REQUIREMENTS

- A. General: Provide glazing systems capable of withstanding normal thermal movement and wind and impact loads (where applicable) without failure, including loss or glass breakage attributable to the following: defective manufacture, fabrication, and installation; failure of sealants or gaskets to remain watertight and airtight; deterioration of glazing materials; or other defects in construction.
- B. Thermal Movements: Provide glazing that allows for thermal movements resulting from the following maximum change (range) in ambient and surface temperatures acting on glass framing members and glazing components. Base engineering calculation on surface temperatures of materials due to both solar heat gain and nighttime-sky heat loss.
 - 1. Temperature Change (Range): 120 deg F (67 deg C), ambient; 180 deg F (100 deg C), material surfaces.
- C. Thermal and Optical Performance Properties: Provide glass with performance properties specified based on manufacturer's published test data, as determined according to procedures indicated below:
 - 1. For monolithic-glass lites, properties are based on units with lites 6.0 mm thick.
 - 2. For laminated-glass lites, properties are based on products of construction indicated.
 - 3. For insulating-glass units, properties are based on units with lites 6.0 mm thick and a nominal 1/2-inch- (12.7-mm-) wide interspace.
 - 4. Center-of-Glass Values: Based on using LBL-44789 WINDOW 5.0 computer program for the following methodologies:
 - a. U-Factors: NFRC 100 expressed as Btu/ sq. ft. x h x deg F (W/sq. m x K).
 - b. Solar Heat Gain Coefficient: NFRC 200.
 - c. Solar Optical Properties: NFRC 300.

1.5 SUBMITTALS

- A. Product Data: For each glass product and glazing material indicated.
- B. Samples: For the following products, in the form of 12-inch- (300-mm-) square Samples for glass.
 - 1. Each color of tinted float glass.
 - a. Provide samples of colors as selected by Architect.
 - 2. Coated vision glass.
 - 3. Insulating glass for each designation indicated.
 - 4. For each color (except black) of exposed glazing sealant indicated.
- C. Glazing Schedule: Use same designations indicated on Drawings for glazed openings in preparing a schedule listing glass types and thicknesses for each size opening and location.
- D. Product Certificates: Signed by manufacturers of glass and glazing products certifying that products furnished comply with requirements.
 - 1. For solar-control low-e-coated glass, provide documentation demonstrating that manufacturer of coated glass is certified by coating manufacturer.
- E. Warranties: Special warranties specified in this Section.

1.6 QUALITY ASSURANCE

- A. Installer Qualifications: An experienced installer who has completed glazing similar in material, design, and extent to that indicated for this Project; whose work has resulted in glass installations with a record of successful in-service performance; and who employs glass installers for this Project who are certified under the National Glass Association Glazier Certification Program as Level 2 (Senior Glaziers) or Level 3 (Master Glaziers).
- B. Source Limitations for Glass: Obtain glass through one source from a single manufacturer for each glass type.
- C. Source Limitations for Glass Sputter-Coated with Solar-Control Low-E Coatings: Where solar-control low-e coatings of a primary glass manufacturer that has established a certified fabricator program is specified, obtain sputter-coated solar-control low-e-coated glass in fabricated units from a manufacturer that is certified by coated-glass manufacturer.
- D. Source Limitations for Glazing Accessories: Obtain glazing accessories through one source from a single manufacturer for each product and installation method indicated.
- E. Safety Glazing Products: Comply with testing requirements in 16 CFR 1201.
 - 1. Subject to compliance with requirements, obtain safety glazing products permanently marked with certification label of the Safety Glazing Certification Council or another certification agency acceptable to authorities having jurisdiction.
- F. Glazing Publications: Comply with published recommendations of glass product manufacturers and organizations below, unless more stringent requirements are indicated. Refer to these publications for glazing terms not otherwise defined in this Section or in referenced standards.
 - 1. GANA Publications: GANA Laminated Division's "Laminated Glass Design Guide" and GANA's "Glazing Manual."
 - 2. IGMA Publication for Insulating Glass: SIGMA TM-3000, "Glazing Guidelines for Sealed Insulating Glass Units."
- G. Insulating-Glass Certification Program: Permanently marked either on spacers or on at least one component lite of units with appropriate certification label of the following testing and inspecting agency:
 - 1. Insulating Glass Certification Council.

1.7 DELIVERY, STORAGE, AND HANDLING

- A. Protect glazing materials according to manufacturer's written instructions and as needed to prevent damage to glass and glazing materials from condensation, temperature changes, direct exposure to sun, or other causes.
- B. For insulating-glass units that will be exposed to substantial altitude changes, comply with insulating-glass manufacturer's written recommendations for venting and sealing to avoid hermetic seal ruptures.

1.8 PROJECT CONDITIONS

- A. Environmental Limitations: Do not proceed with glazing when ambient and substrate temperature conditions are outside limits permitted by glazing material manufacturers and when glazing channel substrates are wet from rain, frost, condensation, or other causes.

1.9 WARRANTY

- A. Manufacturer's Special Warranty for Coated-Glass Products: Manufacturer's standard form, made out to Owner and signed by coated-glass manufacturer agreeing to replace coated-glass units that deteriorate as defined in "Definitions" Article, f.o.b. the nearest shipping point to Project site, within specified warranty period indicated below.

1. Warranty Period: 10 years from date of Substantial Completion.
- B. Manufacturer's Special Warranty on Insulating Glass: Manufacturer's standard form, made out to Owner and signed by insulating-glass manufacturer agreeing to replace insulating-glass units that deteriorate as defined in "Definitions" Article, f.o.b. the nearest shipping point to Project site, within specified warranty period indicated below.
 1. Warranty Period: 10 years from date of Substantial Completion.

PART 2 - PRODUCTS

2.1 MANUFACTURERS

- A. In other Part 2 articles where titles below introduce lists, the following requirements apply to product selection:
 1. Product: Subject to compliance with requirements, provide product specified.
 2. Manufacturers: Subject to compliance with requirements, provide products by one of the manufacturers specified.
 3. Basis-of-Design Product: The design for each glazing product is based on the product named. Subject to compliance with requirements, provide either the named product or a comparable product by one of the other manufacturers specified.

2.2 GLASS PRODUCTS

- A. Annealed Float Glass: ASTM C 1036, Type I (transparent flat glass), Quality-Q3; of class indicated.
 1. Ultra-Clear (Low-Iron) Float Glass: Class I (clear); with a minimum 91 percent visible light transmission and a minimum solar heat gain coefficient of 0.87.
 - a. Available Products:
 - 1) AFG Industries Inc.; Krystal Klear.
 - 2) Pilkington Building Products North America; Optiwhite.
 - 3) PPG Industries, Inc.; Starphire.
 - 4) Schott Corporation; Amiran.
- B. Heat-Treated Float Glass: ASTM C 1048; Type I (transparent flat glass); Quality-Q3; of class, kind, and condition indicated.
 1. Fabrication Process: By horizontal (roller-hearth) process with roll-wave distortion parallel to bottom edge of glass as installed, unless otherwise indicated.
 2. Provide Kind HS (heat-strengthened) float glass in place of annealed float glass where needed to resist thermal stresses induced by differential shading of individual glass lites and to comply with glass design requirements specified in Part 1 "Performance Requirements" Article.
 3. For uncoated glass, comply with requirements for Condition A.
 4. For coated vision glass, comply with requirements for Condition C (other uncoated glass).
 5. Provide Kind FT (fully tempered) float glass in place of annealed or Kind HS (heat-strengthened) float glass where safety glass is indicated.
- C. Pyrolytic-Coated Float Glass: ASTM C 1376, float glass with metallic-oxide coating applied by pyrolytic deposition process during initial manufacture, and complying with other requirements specified.
- D. Insulating-Glass Units, General: Factory-assembled units consisting of sealed lites of glass separated by a dehydrated interspace, and complying with ASTM E 774 for Class CBA units and with requirements specified in this Article and in Part 2 "Insulating-Glass Units" Article.
 1. Provide Kind HS (heat-strengthened) float glass in place of annealed glass where needed to resist thermal stresses induced by differential shading of individual glass lites and to comply with glass design requirements specified in Part 1 "Performance Requirements" Article.
 2. Provide Kind FT (fully tempered) glass lites where safety glass is indicated.
 3. Overall Unit Thickness and Thickness of Each Lite: Dimensions indicated for insulating-glass units are nominal and the overall thicknesses of units are measured perpendicularly from outer surfaces of glass lites at unit's edge.
 4. Sealing System: Dual seal, with primary and secondary sealants as follows:
 - a. Manufacturer's standard sealants.
 5. Spacer Specifications: Manufacturer's standard spacer material and construction complying with the following requirements:
 - a. Spacer Material: Aluminum with black, color anodic finish.
 - b. Desiccant: Molecular sieve or silica gel, or blend of both.
 - c. Corner Construction: Manufacturer's standard corner construction.

2.3 GLAZING GASKETS

- A. Dense Compression Gaskets: Molded or extruded gaskets of material indicated below, complying with standards referenced with name of elastomer indicated below, and of profile and hardness required to maintain watertight seal:
1. Neoprene, ASTM C 864.
 2. EPDM, ASTM C 864.
 3. Silicone, ASTM C 1115.
 4. Thermoplastic polyolefin rubber, ASTM C 1115.
 5. Any material indicated above.
- B. Soft Compression Gaskets: Extruded or molded, closed-cell, integral-skinned gaskets of material indicated below; complying with ASTM C 509, Type II, black; and of profile and hardness required to maintain watertight seal:
1. Neoprene.
 2. EPDM.
 3. Silicone.
 4. Thermoplastic polyolefin rubber.
 5. Any material indicated above.

2.4 GLAZING SEALANTS

- A. General: Provide products of type indicated, complying with the following requirements:
1. Compatibility: Select glazing sealants that are compatible with one another and with other materials they will contact, including glass products, seals of insulating-glass units, and glazing channel substrates, under conditions of service and application, as demonstrated by sealant manufacturer based on testing and field experience.
 2. Suitability: Comply with sealant and glass manufacturers' written instructions for selecting glazing sealants suitable for applications indicated and for conditions existing at time of installation.
 3. Colors of Exposed Glazing Sealants: As selected by Architect from manufacturer's full range.
- B. Elastomeric Glazing Sealants: Comply with ASTM C 920 and other requirements indicated for each liquid-applied chemically curing sealant specified, including those referencing ASTM C 920 classifications for type, grade, class, and uses related to exposure and joint substrates.
1. Single-Component Neutral-Curing Silicone Glazing Sealants GS-:
 - a. Available Products:
 - 1) GE Silicones; SilPruf SCS2000.
 - 2) Pecora Corporation; 864.
 - 3) Pecora Corporation; 890.
 - 4) Polymeric Systems Inc.; PSI-641.
 - 5) Sonneborn, Div. of ChemRex, Inc.; Omniseal.
 - 6) Tremco; Spectrem 3.
 - b. Type and Grade: S (single component) and NS (nonsag).
 - c. Class: 50.
 - d. Use Related to Exposure: NT (nontraffic).
 - e. Uses Related to Glazing Substrates: M, G, A, and, as applicable to glazing substrates indicated, O.
- C. Glazing Sealants for Fire-Resistive Glazing Products: Identical to products used in test assemblies to obtain fire-protection rating.

2.5 GLAZING TAPES

- A. Back-Bedding Mastic Glazing Tapes: Preformed, butyl-based elastomeric tape with a solids content of 100 percent; nonstaining and nonmigrating in contact with nonporous surfaces; with or without spacer rod as recommended in writing by tape and glass manufacturers for application indicated; packaged on rolls with a release paper backing; and complying with ASTM C 1281 and AAMA 800 for products indicated below:
1. AAMA 806.3 tape, for glazing applications in which tape is subject to continuous pressure.

2.6 MISCELLANEOUS GLAZING MATERIALS

- A. General: Provide products of material, size, and shape complying with referenced glazing standard, requirements of manufacturers of glass and other glazing materials for application indicated, and with a proven record of compatibility with surfaces contacted in installation.
- B. Cleaners, Primers, and Sealers: Types recommended by sealant or gasket manufacturer.

- C. Setting Blocks: Elastomeric material with a Shore, Type A durometer hardness of 85, plus or minus 5.
- D. Spacers: Elastomeric blocks or continuous extrusions with a Shore, Type A durometer hardness required by glass manufacturer to maintain glass lites in place for installation indicated.
- E. Edge Blocks: Elastomeric material of hardness needed to limit glass lateral movement (side walking).

2.7 FABRICATION OF GLAZING UNITS

- A. Fabricate glazing units in sizes required to glaze openings indicated for Project, with edge and face clearances, edge and surface conditions, and bite complying with written instructions of product manufacturer and referenced glazing publications, to comply with system performance requirements.

2.8 MONOLITHIC FLOAT-GLASS UNITS

A. MG-1 Uncoated Clear Float-Glass Units:

- 1. Kind: Provide one of the following as shown on the drawings.
 - a. Class 1 (clear) annealed or Kind HS (heat-strengthened) float glass where heat strengthening is required to resist thermal stresses induced by differential shading of individual glass lites and to comply with system performance requirements
 - b. Kind HS (heat-strengthened) float glass
 - c. Kind FT (fully tempered) float glass, where indicated.
- 2. Thickness: 6.0 mm.

B. ~~MG-2 Coated tinted Float Glass Units:~~

- 1. ~~Kind: Provide one of the following as shown on the drawings.~~
 - a. ~~Class 2 (tinted) annealed or Kind HS (heat strengthened) float glass where heat strengthening is required to resist thermal stresses induced by differential shading of individual glass lites and to comply with system performance requirements~~
 - b. ~~Kind HS (heat strengthened) float glass~~
 - c. ~~Kind FT (fully tempered) float glass, where indicated.~~
- 2. ~~Thickness: 6.0 mm.~~
- 3. ~~Tint Color: PPG Optiblue and PPG Pacifica~~
- 4. ~~Low-E Coating: PPG Solarban z75 and PPG Solarban R100.~~
 - a. ~~Location: #2 surface.~~
- 5. ~~Visible Light Transmittance: Refer to Insulating Glazing Unit Requirements.~~
- 6. ~~Winter Nighttime U Factor: Refer to Insulating Glazing Unit Requirements.~~
- 7. ~~Summer Daytime U Factor: Refer to Insulating Glazing Unit Requirements.~~
- 8. ~~Solar Heat Gain Coefficient: Refer to Insulating Glazing Unit Requirements.~~
- 9. ~~Outdoor Visible Reflectance: Refer to Insulating Glazing Unit Requirements.~~

C. ~~MG-3 Coated Clear Float Glass Units:~~

- 1. ~~Kind: Provide one of the following as shown on the drawings.~~
 - a. ~~Class 1 (clear) annealed or Kind HS (heat strengthened) float glass where heat strengthening is required to resist thermal stresses induced by differential shading of individual glass lites and to comply with system performance requirements~~
 - b. ~~Kind HS (heat strengthened) float glass~~
 - c. ~~Kind FT (fully tempered) float glass~~
- 2. ~~Products:~~
 - a. ~~Pilkington Eclipse Advantage Low-E Glass.~~
- 3. ~~Thickness: 6.0 mm.~~
- 4. ~~Reflective Coating: Pyrolytic.~~
 - a. ~~Location: First surface.~~
- 5. ~~Visible Light Transmittance: 0.66 percent minimum.~~
- 6. ~~Winter Nighttime U Factor: 0.67 maximum.~~
- 7. ~~Summer Daytime U Factor: 0.53 maximum.~~
- 8. ~~Solar Heat Gain Coefficient: 0.61 maximum.~~
- 9. ~~Outdoor Visible Reflectance: 0.22 percent maximum.~~

2.9 INSULATING-GLASS UNITS

A. Solar-Control Low-E Insulating-Glass Units: G3 Designation

- 1. Basis of Design Product: Vitro Solarban z75 (2) Optiblue + 1/2" Air + Clear

2. Acceptable Manufacturers:
 - a. PPG Industries
 - b. Pilkington
 - c. Or equal
 3. Overall Unit Thickness and Thickness of Each Lite: As indicated.
 4. Interspace Content: Air.
 5. Outdoor Lite: Class 2 (tinted) float glass.
 - a. Tint Color: PPG Optiblu.
 - b. Low-E Coating: PPG Solarban z75
 6. Indoor Lite: Class 1 (clear) float glass.
 - a. Kind HS (heat strengthened).
 7. Visible Light Transmittance: 48 percent minimum.
 8. Winter Nighttime U-Factor: 0.28 maximum.
 9. Exterior Reflectance: 9% maximum.
 10. Interior Reflectance: 12% maximum.
 11. Solar Heat Gain Coefficient: 0.24 maximum.
 12. Shading Coefficient: 0.28 maximum.
- B. Solar-Control Low-E Insulating-Glass Units: G4 Designation
1. Basis of Design Product: Vitro Solarban R100 (2) Pacifica + 1/2" Air + Clear
 2. Available Products:
 - a. PPG Industries
 - b. Pilkington
 - c. Or equal
 3. Overall Unit Thickness and Thickness of Each Lite: As indicated.
 4. Interspace Content: Air.
 5. Outdoor Lite: Class 2 (tinted) float glass.
 - a. Tint Color: PPG Pacifica.
 - b. Low-E Coating: PPG Solarban R100
 6. Indoor Lite: Class 1 (clear) float glass.
 - a. Kind HS (heat strengthened).
 7. Visible Light Transmittance: 20 percent minimum.
 8. Winter Nighttime U-Factor: 0.29 maximum.
 9. Exterior Reflectance: 11% minimum.
 10. Interior Reflectance: 13% minimum.
 11. Solar Heat Gain Coefficient: 0.16 maximum.
 12. Shading Coefficient: 0.19 maximum.

PART 3 - EXECUTION

3.1 EXAMINATION

- A. Examine framing glazing, with Installer present, for compliance with the following:
 1. Manufacturing and installation tolerances, including those for size, squareness, and offsets at corners.
 2. Presence and functioning of weep system.
 3. Minimum required face or edge clearances.
 4. Effective sealing between joints of glass-framing members.
- B. Proceed with installation only after unsatisfactory conditions have been corrected.

3.2 PREPARATION

- A. Clean glazing channels and other framing members receiving glass immediately before glazing. Remove coatings not firmly bonded to substrates.

3.3 GLAZING, GENERAL

- A. Comply with combined written instructions of manufacturers of glass, sealants, gaskets, and other glazing materials, unless more stringent requirements are indicated, including those in referenced glazing publications.

- B. Glazing channel dimensions, as indicated on Drawings, provide necessary bite on glass, minimum edge and face clearances, and adequate sealant thicknesses, with reasonable tolerances. Adjust as required by Project conditions during installation.
- C. Protect glass edges from damage during handling and installation. Remove damaged glass from Project site and legally dispose of off Project site. Damaged glass is glass with edge damage or other imperfections that, when installed, could weaken glass and impair performance and appearance.
- D. Apply primers to joint surfaces where required for adhesion of sealants, as determined by preconstruction sealant-substrate testing.
- E. Install setting blocks in sill rabbets, sized and located to comply with referenced glazing publications, unless otherwise required by glass manufacturer. Set blocks in thin course of compatible sealant suitable for heel bead.
- F. Do not exceed edge pressures stipulated by glass manufacturers for installing glass lites.
- G. Provide spacers for glass lites where length plus width is larger than 50 inches (1270 mm) as follows:
 - 1. Locate spacers directly opposite each other on both inside and outside faces of glass. Install correct size and spacing to preserve required face clearances, unless gaskets and glazing tapes are used that have demonstrated ability to maintain required face clearances and to comply with system performance requirements.
 - 2. Provide 1/8-inch (3-mm) minimum bite of spacers on glass and use thickness equal to sealant width. With glazing tape, use thickness slightly less than final compressed thickness of tape.
- H. Provide edge blocking where indicated or needed to prevent glass lites from moving sideways in glazing channel, as recommended in writing by glass manufacturer and according to requirements in referenced glazing publications.
- I. Set glass lites in each series with uniform pattern, draw, bow, and similar characteristics.
- J. Where wedge-shaped gaskets are driven into one side of channel to pressurize sealant or gasket on opposite side, provide adequate anchorage so gasket cannot walk out when installation is subjected to movement.
- K. Square cut wedge-shaped gaskets at corners and install gaskets in a manner recommended by gasket manufacturer to prevent corners from pulling away; seal corner joints and butt joints with sealant recommended by gasket manufacturer.

3.4 TAPE GLAZING

- A. Position tapes on fixed stops so that, when compressed by glass, their exposed edges are flush with or protrude slightly above sightline of stops.
- B. Install tapes continuously, but not necessarily in one continuous length. Do not stretch tapes to make them fit opening.
- C. Cover vertical framing joints by applying tapes to heads and sills first and then to jambs. Cover horizontal framing joints by applying tapes to jambs and then to heads and sills.
- D. Place joints in tapes at corners of opening with adjoining lengths butted together, not lapped. Seal joints in tapes with compatible sealant approved by tape manufacturer.
- E. Do not remove release paper from tape until just before each glazing unit is installed.
- F. Center glass lites in openings on setting blocks and press firmly against tape by inserting dense compression gaskets formed and installed to lock in place against faces of removable stops. Start gasket applications at corners and work toward centers of openings.

3.5 GASKET GLAZING (DRY)

- A. Fabricate compression gaskets in lengths recommended by gasket manufacturer to fit openings exactly, with allowance for stretch during installation.
- B. Insert soft compression gasket between glass and frame or fixed stop so it is securely in place with joints miter cut and bonded together at corners.
- C. Center glass lites in openings on setting blocks and press firmly against soft compression gasket by inserting dense compression gaskets formed and installed to lock in place against faces of removable stops. Start gasket applications at corners and work toward centers of openings. Compress gaskets to produce a weathertight seal without developing bending stresses in glass. Seal gasket joints with sealant recommended by gasket manufacturer.
- D. Install gaskets so they protrude past face of glazing stops.

3.6 SEALANT GLAZING (WET)

- A. Install continuous spacers, or spacers combined with cylindrical sealant backing, between glass lites and glazing stops to maintain glass face clearances and to prevent sealant from extruding into glass channel and blocking weep systems until sealants cure. Secure spacers or spacers and backings in place and in position to control depth of installed sealant relative to edge clearance for optimum sealant performance.

- B. Force sealants into glazing channels to eliminate voids and to ensure complete wetting or bond of sealant to glass and channel surfaces.
- C. Tool exposed surfaces of sealants to provide a substantial wash away from glass.

3.7 CLEANING AND PROTECTION

- A. Protect exterior glass from damage immediately after installation by attaching crossed streamers to framing held away from glass. Do not apply markers to glass surface. Remove nonpermanent labels, and clean surfaces.
- B. Protect glass from contact with contaminating substances resulting from construction operations, including weld splatter. If, despite such protection, contaminating substances do come into contact with glass, remove substances immediately as recommended by glass manufacturer.
- C. Examine glass surfaces adjacent to or below exterior concrete and other masonry surfaces at frequent intervals during construction, but not less than once a month, for buildup of dirt, scum, alkaline deposits, or stains; remove as recommended in writing by glass manufacturer.
- D. Remove and replace glass that is broken, chipped, cracked, or abraded or that is damaged from natural causes, accidents, and vandalism, during construction period.
- E. Wash glass on both exposed surfaces in each area of Project not more than four days before date scheduled for inspections that establish date of Substantial Completion. Wash glass as recommended in writing by glass manufacturer.

END OF SECTION 08800



ADDENDUM NO. 5:

Date: March 28, 2017
 Project: The EDGE Business Resource Center
 Owner: The City of Tuscaloosa
 Owner's Project No: A16-1320 (Previously City #A14-1210)
 Architect: Ward Scott Architecture, Inc.

This Addendum forms a part of the Contract Documents and modifies the original Bid Documents dated July 30, 2015, as noted below.

Acknowledge receipt of this Addendum in the location provided on the Bid Proposal Form.

1.1 GENERAL

A. N/A

1.2 SPECIFICATIONS AND DRAWINGS

A. Specifications:

1. Refer to Front End Documents
 - a. Davis-Bacon Wage Rates are located after the List of Certified Surety Companies and before the EDA Contracting Guidelines. Wage Rates are attached to this addendum for reference.
 - 1) Wage rates for Fire Sprinkler Fitters shall utilize 'Plumber' classification for bidding purposes.
2. Refer to Trade Package Summaries of Work
 - a. EDGE – 01 Site Work Trade Package will be responsible for exterior concrete pavement, curb and gutter, valley gutter, sidewalks, standup curb, permanent post mounted signs, truncated domes and parking stops per the unit price schedule. This trade package is responsible for the Sitework Unit Price Schedule in its entirety.
 - b. EDGE – 02 General Trade Package will no longer be responsible for these items. Revise Scope of work Item #24 as follows:

24. This Trade Contractor is responsible for concrete for interior slabs-on-grade, interior slabs on metal deck, foundations, footings, piers, beams, below grade block fill and reinforcing steel, housekeeping pads, ~~sidewalks, concrete paving, curb and gutter, concrete formed inlets, valley gutter, patios, door stoops~~ **and all** reinforcing, reinforcing accessories, excavation spoil removal from site, backfill, fine grading, saw cutting/control joints, paving joint sealants, curing, porous under slab fill, termite pretreat, vapor barriers, exterior utility pads, dowels, stone base under all concrete, recesses, and finishing as required **associated with the concrete included in this scope**.

 - 1) This requirement supersedes Addendum 3 Paragraph 1.2.A.1.b. regarding crushed aggregate base. All base shall be included at concrete included with the respective package.
3. Refer to Landscaping Unit Price Schedule.
 - a. For clarification, there shall be no separate line item for pine bark mulching. Mulch shall be included in the unit price for each plant item.
4. Refer to Specification Section 023119 Decorative Metal Fencing and Gates. Add the following to Paragraph 2.2 Decorative Steel Fences:
 - I. Acceptable Basis-of-Design Products:
 1. Factory preassembled fence panels and posts by Ameristar Fence or equal conforming to the requirements of the plans and specifications.
 2. Shop- and field-assembled fencing by steel supplier conforming to the requirements of the plans and specifications.

5. Insert the attached Specification Section 084223 Structural-Sealant-Glazed Aluminum Curtain Wall in the project manual. This specification shall apply to openings SF2A and SF2B.
- B. Drawings:
1. Refer to Sheet L-2 Landscaping Details:
 - a. Revise Planting Schedule item for 'Empire' Zoysia Sod to 7,155 sy to match Unit Price Schedule.
 2. Refer to Sheet A002 Opening Schedule & Elevations
 - a. Replace this sheet with the attached revised sheet. Revise vertical members of curtain wall to 2" nominal bypassing steel bridging at locations indicated as 6" nominal.
 3. Replace Sheet A101 in its entirety. All masonry control joints are located on the revised sheet.
 4. See attached Supplemental Drawing SD-5 for structural member penetration at Frame Elevations SF2A and SF2B.
 5. Refer to Elevation Sheets A201 and A202. Precast joints are noted for general aesthetic purposes. Specified dry-cast cast stone shall be provided and joints shall be adjusted to accommodate general limits of material.
 6. Refer to Sheet E301. Installation of STI Series 44 EZ-Path units with extension modules as required are acceptable at expansion joints.
 7. Refer to Addendum 4, Paragraph 1.2.B.5.b. and Sheet TD101. Each floor box should have one (1) 1" conduit home run to 'I.T. 134' for future data cabling by others. All floor boxes with A/V requirements as indicated on Sheet TD102 shall have one (1) 1 1/4" conduit home run to 'A/V 105' for future A/V cabling by others. Only two (2) floor boxes may be combined per home run.
 8. Refer to Sheets TD-101, TD102, and TD-301. Regarding 'City Walk Project QB/Vault requirements, there are two (2) QB Vaults shown on Drawings TD-101 and TD102 and just one (1) on Drawing TD-301. It shall be the responsibility of the Electrical Contractor to provide and install One (1) 4'x6'x4' Vault. The Vault shown inside the Property Line shall be included in the contract under the Electrical/ DataCom Contractors scope. The second vault outside the property line will be installed under a separate contract.

1.3 ATTACHED TO ADDENDUM

- A. Davis-Bacon Wage Rates
- B. Supplemental Sheet SD-5
- C. Revised Sheet A002 Opening Schedule and Elevations.
- D. Revised Sheet A101 Floor Plan
- E. Specification Section 084223 Structural-Sealant Glazed Curtain Walls

END OF ADDENDUM

General Decision Number: AL170063 01/06/2017 AL63

Superseded General Decision Number: AL20160063

State: Alabama

Construction Type: Building

County: Tuscaloosa County in Alabama.

The Edge- Building

BUILDING CONSTRUCTION PROJECTS (does not include single family homes or apartments up to and including 4 stories).

Note: Under Executive Order (EO) 13658, an hourly minimum wage of \$10.20 for calendar year 2017 applies to all contracts subject to the Davis-Bacon Act for which the contract is awarded (and any solicitation was issued) on or after January 1, 2015. If this contract is covered by the EO, the contractor must pay all workers in any classification listed on this wage determination at least \$10.20 per hour (or the applicable wage rate listed on this wage determination, if it is higher) for all hours spent performing on the contract in calendar year 2017. The EO minimum wage rate will be adjusted annually. Additional information on contractor requirements and worker protections under the EO is available at www.dol.gov/whd/govcontracts.

Modification Number 0 Publication Date 01/06/2017

ENGI0312-007 09/01/2011

	Rates	Fringes
Operating Engineers:		
Crane, Cherry Picker, Forklift, and Front End		
Loader.....	\$ 25.90	10.65
Oiler.....	\$ 22.83	10.65

Cranes with 100 ft. or more boom receive \$0.25 extra per hour,
Cranes with 200 ft. or more boom receive \$0.50 extra per hour,
Cranes with 350 ft. or more boom receive \$1.10 extra per hour,
Cranes with 500 ft. or more boom receive \$1.45 extra per hour,
Tower Cranes, Derricks, Climbing Cranes, Ringer Cranes shall receive \$0.35 in addition to A-rate and boom pay per hour

* IRON0092-002 05/01/2016

	Rates	Fringes
IRONWORKER, STRUCTURAL.....	\$ 24.06	13.68

SUAL2007-055 10/02/2007

	Rates	Fringes
BRICKLAYER.....	\$ 17.00	0.00
CARPENTER, Includes Form Work....	\$ 17.00	0.00
CEMENT MASON/CONCRETE FINISHER...	\$ 11.84	0.00

Wages ran 3/13/17

ELECTRICIAN.....	\$ 18.83	0.00
IRONWORKER, REINFORCING.....	\$ 8.00	0.00
LABORER: Common/General, Including Landscaping.....	\$ 9.00	0.00
LABORER: Pipelayer.....	\$ 9.15	1.18
OPERATOR: Backhoe.....	\$ 15.03	4.35
OPERATOR: Bulldozer.....	\$ 14.89	2.47
OPERATOR: Excavator.....	\$ 16.00	0.00
OPERATOR: Grader/Blade.....	\$ 13.83	0.00
PAINTER: Brush, Roller and Spray.....	\$ 12.85	0.00
PIPEFITTER.....	\$ 8.00	0.00
PLUMBER.....	\$ 14.28	0.00
ROOFER, Includes Built Up, Polyurethane Foam, Metal, Shake & Shingle, and Single Ply Roofs.....	\$ 11.79	0.00
SHEET METAL WORKER.....	\$ 13.00	0.00
TILE SETTER.....	\$ 13.00	0.72
TRUCK DRIVER.....	\$ 12.29	1.53

WELDERS - Receive rate prescribed for craft performing operation to which welding is incidental.

=====

Note: Executive Order (EO) 13706, Establishing Paid Sick Leave for Federal Contractors applies to all contracts subject to the Davis-Bacon Act for which the contract is awarded (and any solicitation was issued) on or after January 1, 2017. If this contract is covered by the EO, the contractor must provide employees with 1 hour of paid sick leave for every 30 hours they work, up to 56 hours of paid sick leave each year. Employees must be permitted to use paid sick leave for their own illness, injury or other health-related needs, including preventive care; to assist a family member (or person who is like family to the employee) who is ill, injured, or has other health-related needs, including preventive care; or for reasons resulting from, or to assist a family member (or person who is like family to the employee) who is a victim of, domestic violence, sexual assault, or stalking. Additional information on contractor requirements and worker protections under the EO is available at www.dol.gov/whd/govcontracts.

Unlisted classifications needed for work not included within the scope of the classifications listed may be added after award only as provided in the labor standards contract clauses (29CFR 5.5 (a) (1) (ii)).

The body of each wage determination lists the classification and wage rates that have been found to be prevailing for the cited type(s) of construction in the area covered by the wage determination. The classifications are listed in alphabetical order of "identifiers" that indicate whether the particular rate is a union rate (current union negotiated rate for local), a survey rate (weighted average rate) or a union average rate (weighted union average rate).

Union Rate Identifiers

A four letter classification abbreviation identifier enclosed in dotted lines beginning with characters other than "SU" or "UAVG" denotes that the union classification and rate were prevailing for that classification in the survey. Example: PLUM0198-005 07/01/2014. PLUM is an abbreviation identifier of the union which prevailed in the survey for this classification, which in this example would be Plumbers. 0198 indicates the local union number or district council number where applicable, i.e., Plumbers Local 0198. The next number, 005 in the example, is an internal number used in processing the wage determination. 07/01/2014 is the effective date of the most current negotiated rate, which in this example is July 1, 2014.

Union prevailing wage rates are updated to reflect all rate changes in the collective bargaining agreement (CBA) governing this classification and rate.

Survey Rate Identifiers

Classifications listed under the "SU" identifier indicate that no one rate prevailed for this classification in the survey and the published rate is derived by computing a weighted average rate based on all the rates reported in the survey for that classification. As this weighted average rate includes all rates reported in the survey, it may include both union and non-union rates. Example: SULA2012-007 5/13/2014. SU indicates the rates are survey rates based on a weighted average calculation of rates and are not majority rates. LA indicates the State of Louisiana. 2012 is the year of survey on which these classifications and rates are based. The next number, 007 in the example, is an internal number used in producing the wage determination. 5/13/2014 indicates the survey completion date for the classifications and rates under that identifier.

Survey wage rates are not updated and remain in effect until a new survey is conducted.

Union Average Rate Identifiers

Classification(s) listed under the UAVG identifier indicate that no single majority rate prevailed for those classifications; however, 100% of the data reported for the classifications was union data. EXAMPLE: UAVG-OH-0010 08/29/2014. UAVG indicates that the rate is a weighted union average rate. OH indicates the state. The next number, 0010 in the example, is an internal number used in producing the wage determination. 08/29/2014 indicates the survey completion date for the classifications and rates under that identifier.

A UAVG rate will be updated once a year, usually in January of each year, to reflect a weighted average of the current negotiated/CBA rate of the union locals from which the rate is based.

WAGE DETERMINATION APPEALS PROCESS

1.) Has there been an initial decision in the matter? This can be:

- * an existing published wage determination
- * a survey underlying a wage determination
- * a Wage and Hour Division letter setting forth a position on a wage determination matter
- * a conformance (additional classification and rate) ruling

On survey related matters, initial contact, including requests for summaries of surveys, should be with the Wage and Hour Regional Office for the area in which the survey was conducted because those Regional Offices have responsibility for the Davis-Bacon survey program. If the response from this initial contact is not satisfactory, then the process described in 2.) and 3.) should be followed.

With regard to any other matter not yet ripe for the formal process described here, initial contact should be with the Branch of Construction Wage Determinations. Write to:

Branch of Construction Wage Determinations
Wage and Hour Division
U.S. Department of Labor
200 Constitution Avenue, N.W.
Washington, DC 20210

2.) If the answer to the question in 1.) is yes, then an interested party (those affected by the action) can request review and reconsideration from the Wage and Hour Administrator (See 29 CFR Part 1.8 and 29 CFR Part 7). Write to:

Wage and Hour Administrator
U.S. Department of Labor
200 Constitution Avenue, N.W.
Washington, DC 20210

The request should be accompanied by a full statement of the interested party's position and by any information (wage payment data, project description, area practice material, etc.) that the requestor considers relevant to the issue.

3.) If the decision of the Administrator is not favorable, an interested party may appeal directly to the Administrative Review Board (formerly the Wage Appeals Board). Write to:

Administrative Review Board
U.S. Department of Labor
200 Constitution Avenue, N.W.
Washington, DC 20210

4.) All decisions by the Administrative Review Board are final.

END OF GENERAL DECISION

General Decision Number: AL170002 01/06/2017 AL2

Superseded General Decision Number: AL20160002

State: Alabama

Construction Type: Highway

Counties: Blount, Calhoun, Etowah, Shelby, St Clair and Tuscaloosa Counties in Alabama.

The Edge - Parking lot

HIGHWAY CONSTRUCTION PROJECTS (excluding tunnels, bulding structures in rest areas projects, and railroad construction; bascule, suspension & spandrel arch bridges desgned for commercial navigation; bridges involving marine construction; other major bridges)

Note: Under Executive Order (EO) 13658, an hourly minimum wage of \$10.20 for calendar year 2017 applies to all contracts subject to the Davis-Bacon Act for which the contract is awarded (and any solicitation was issued) on or after January 1, 2015. If this contract is covered by the EO, the contractor must pay all workers in any classification listed on this wage determination at least \$10.20 per hour (or the applicable wage rate listed on this wage determination, if it is higher) for all hours spent performing on the contract in calendar year 2017. The EO minimum wage rate will be adjusted annually. Additional information on contractor requirements and worker protections under the EO is available at www.dol.gov/whd/govcontracts.

Modification Number Publication Date
0 01/06/2017

* SUAL2011-001 01/04/2011

	Rates	Fringes
Carpenter.....	\$ 13.88	
Concrete finisher.....	\$ 13.26	
Electrician.....	\$ 19.73	
Laborers:		
Asphalt Raker.....	\$ 11.23	
Concrete Laborer.....	\$ 10.84	
Grade Checker.....	\$ 12.58	
Guardrail Erector.....	\$ 12.47	
Pipe Layer.....	\$ 12.58	
Side Rail/Form Setter.....	\$ 11.97	
Traffic Control Specialist..	\$ 11.27	
Unskilled.....	\$ 9.84	
Power equipment operators:		
Aggregate Spreader.....	\$ 14.17	
Asphalt Distributor.....	\$ 14.27	
Asphalt Paver.....	\$ 11.85	
Asphalt Spreader.....	\$ 13.65	
Backhoe, Clamshell, Dragline, and Shovel.....	\$ 15.87	
Broom (Sweeper).....	\$ 11.68	

Wtged van 2/13/17

Bulldozer.....	\$ 14.73
Crane & Derrick.....	\$ 20.63
Front End Loader.....	\$ 13.38
Mechanic.....	\$ 17.54
Milling Machine.....	\$ 12.31
Motor Grader and Motor Patrol.....	\$ 16.10
Oiler/Greaseman.....	\$ 13.33
Roller (Self-Propelled).....	\$ 12.38
Scraper.....	\$ 13.00
Striping Machine.....	\$ 15.20
Track Hoe/Excavator.....	\$ 14.64
Tractor and Loader (farm rubber tired).....	\$ 11.40
Tractor/Loader (all other work).....	\$ 11.22

Truck drivers:

Multi-Rear Axle.....	\$ 12.25
Single Rear Axle.....	\$ 11.54

WELDERS - Receive rate prescribed for craft performing operation to which welding is incidental.

=====

Note: Executive Order (EO) 13706, Establishing Paid Sick Leave for Federal Contractors applies to all contracts subject to the Davis-Bacon Act for which the contract is awarded (and any solicitation was issued) on or after January 1, 2017. If this contract is covered by the EO, the contractor must provide employees with 1 hour of paid sick leave for every 30 hours they work, up to 56 hours of paid sick leave each year. Employees must be permitted to use paid sick leave for their own illness, injury or other health-related needs, including preventive care; to assist a family member (or person who is like family to the employee) who is ill, injured, or has other health-related needs, including preventive care; or for reasons resulting from, or to assist a family member (or person who is like family to the employee) who is a victim of, domestic violence, sexual assault, or stalking. Additional information on contractor requirements and worker protections under the EO is available at www.dol.gov/whd/govcontracts.

Unlisted classifications needed for work not included within the scope of the classifications listed may be added after award only as provided in the labor standards contract clauses (29CFR 5.5 (a) (1) (ii)).

The body of each wage determination lists the classification and wage rates that have been found to be prevailing for the cited type(s) of construction in the area covered by the wage determination. The classifications are listed in alphabetical order of "identifiers" that indicate whether the particular rate is a union rate (current union negotiated rate for local), a survey rate (weighted average rate) or a union average rate (weighted union average rate).

Union Rate Identifiers

A four letter classification abbreviation identifier enclosed in dotted lines beginning with characters other than "SU" or "UAVG" denotes that the union classification and rate were prevailing for that classification in the survey. Example: PLUM0198-005 07/01/2014. PLUM is an abbreviation identifier of the union which prevailed in the survey for this classification, which in this example would be Plumbers. 0198 indicates the local union number or district council number where applicable, i.e., Plumbers Local 0198. The next number, 005 in the example, is an internal number used in processing the wage determination. 07/01/2014 is the effective date of the most current negotiated rate, which in this example is July 1, 2014.

Union prevailing wage rates are updated to reflect all rate changes in the collective bargaining agreement (CBA) governing this classification and rate.

Survey Rate Identifiers

Classifications listed under the "SU" identifier indicate that no one rate prevailed for this classification in the survey and the published rate is derived by computing a weighted average rate based on all the rates reported in the survey for that classification. As this weighted average rate includes all rates reported in the survey, it may include both union and non-union rates. Example: SULA2012-007 5/13/2014. SU indicates the rates are survey rates based on a weighted average calculation of rates and are not majority rates. LA indicates the State of Louisiana. 2012 is the year of survey on which these classifications and rates are based. The next number, 007 in the example, is an internal number used in producing the wage determination. 5/13/2014 indicates the survey completion date for the classifications and rates under that identifier.

Survey wage rates are not updated and remain in effect until a new survey is conducted.

Union Average Rate Identifiers

Classification(s) listed under the UAVG identifier indicate that no single majority rate prevailed for those classifications; however, 100% of the data reported for the classifications was union data. EXAMPLE: UAVG-OH-0010 08/29/2014. UAVG indicates that the rate is a weighted union average rate. OH indicates the state. The next number, 0010 in the example, is an internal number used in producing the wage determination. 08/29/2014 indicates the survey completion date for the classifications and rates under that identifier.

A UAVG rate will be updated once a year, usually in January of each year, to reflect a weighted average of the current negotiated/CBA rate of the union locals from which the rate is based.

WAGE DETERMINATION APPEALS PROCESS

1.) Has there been an initial decision in the matter? This can be:

* an existing published wage determination

- * a survey underlying a wage determination
- * a Wage and Hour Division letter setting forth a position on a wage determination matter
- * a conformance (additional classification and rate) ruling

On survey related matters, initial contact, including requests for summaries of surveys, should be with the Wage and Hour Regional Office for the area in which the survey was conducted because those Regional Offices have responsibility for the Davis-Bacon survey program. If the response from this initial contact is not satisfactory, then the process described in 2.) and 3.) should be followed.

With regard to any other matter not yet ripe for the formal process described here, initial contact should be with the Branch of Construction Wage Determinations. Write to:

Branch of Construction Wage Determinations
Wage and Hour Division
U.S. Department of Labor
200 Constitution Avenue, N.W.
Washington, DC 20210

2.) If the answer to the question in 1.) is yes, then an interested party (those affected by the action) can request review and reconsideration from the Wage and Hour Administrator (See 29 CFR Part 1.8 and 29 CFR Part 7). Write to:

Wage and Hour Administrator
U.S. Department of Labor
200 Constitution Avenue, N.W.
Washington, DC 20210

The request should be accompanied by a full statement of the interested party's position and by any information (wage payment data, project description, area practice material, etc.) that the requestor considers relevant to the issue.

3.) If the decision of the Administrator is not favorable, an interested party may appeal directly to the Administrative Review Board (formerly the Wage Appeals Board). Write to:

Administrative Review Board
U.S. Department of Labor
200 Constitution Avenue, N.W.
Washington, DC 20210

4.) All decisions by the Administrative Review Board are final.

=====

◆
END OF GENERAL DECISION

SECTION 084423 – STRUCTURAL-SEALANT-GLAZED CURTAIN WALLS

PART 1 - GENERAL

1.1 RELATED DOCUMENTS

- A. Drawings and general provisions of the Contract, including General and Supplementary Conditions and Division 01 Specification Sections, apply to this Section.

1.2 SUMMARY

- A. Section includes glazed aluminum curtain walls.

1.3 PREINSTALLATION MEETINGS

- A. Pre-installation Conference: Conduct conference at Project site.

1.4 ACTION SUBMITTALS

- A. Product Data: For each type of product.
 - 1. Include construction details, material descriptions, dimensions of individual components and profiles, and finishes.
- B. Shop Drawings: For glazed aluminum curtain walls. Include plans, elevations, sections, full-size details, and attachments to other work.
 - 1. Include details of provisions for assembly expansion and contraction and for draining moisture occurring within the assembly to the exterior.
 - 2. Include full-size isometric details of each vertical-to-horizontal intersection of glazed aluminum curtain walls, showing the following:
 - a. Joinery, including concealed welds.
 - b. Anchorage.
 - c. Expansion provisions.
 - d. Glazing.
 - e. Flashing and drainage.
 - 3. Show connection to and continuity with adjacent thermal, weather, air, and vapor barriers.
- C. Samples for Initial Selection: For units with factory-applied color finishes.
- D. Fabrication Sample: Of each vertical-to-horizontal intersection of assemblies, made from 12-inch (300-mm) lengths of full-size components and showing details of the following:
 - 1. Joinery, including concealed welds.
 - 2. Anchorage.
 - 3. Expansion provisions.
 - 4. Glazing.
 - 5. Flashing and drainage.
- E. Delegated-Design Submittal: For glazed aluminum curtain walls indicated to comply with performance requirements and design criteria, including analysis data signed and sealed by the qualified professional engineer responsible for their preparation.

1.5 INFORMATIONAL SUBMITTALS

- A. Preconstruction Laboratory Mockup Testing Submittals:
 - 1. Testing Program: Developed specifically for Project.
 - 2. Test Reports: Prepared by a qualified preconstruction testing agency for each mockup test.
 - 3. Record Drawings: As-built drawings of preconstruction laboratory mockups showing changes made during preconstruction laboratory mockup testing.
- B. Qualification Data: For Installer.
- C. Energy Performance Certificates: For glazed aluminum curtain walls, accessories, and components from manufacturer.
 - 1. Basis for Certification: NFRC-certified energy performance values for each glazed aluminum curtain wall.
- D. Product Test Reports: For glazed aluminum curtain walls, for tests performed by a qualified testing agency.

- E. Sample Warranties: For special warranties.

1.6 CLOSEOUT SUBMITTALS

- A. Maintenance Data: For glazed aluminum curtain walls to include in maintenance manuals.

1.7 QUALITY ASSURANCE

- A. Installer Qualifications: An entity that employs installers and supervisors who are trained and approved by manufacturer.
- B. Product Options: Information on Drawings and in Specifications establishes requirements for aesthetic effects and performance characteristics of assemblies. Aesthetic effects are indicated by dimensions, arrangements, alignment, and profiles of components and assemblies as they relate to sightlines, to one another, and to adjoining construction.
1. Do not change intended aesthetic effects, as judged solely by Architect, except with Architect's approval. If changes are proposed, submit comprehensive explanatory data to Architect for review.

1.8 MOCKUPS

- A. Mockups: Build mockups to verify selections made under Sample submittals and to demonstrate aesthetic effects and set quality standards for fabrication and installation.
1. Build mockup of typical wall area as shown on Drawings.
 2. Approval of mockups does not constitute approval of deviations from the Contract Documents contained in mockups unless Architect specifically approves such deviations in writing.
 3. Subject to compliance with requirements, approved mockups may become part of the completed Work if undisturbed at time of Substantial Completion.

1.9 WARRANTY

- A. Special Assembly Warranty: Installer agrees to repair or replace components of glazed aluminum curtain wall that do not comply with requirements or that fail in materials or workmanship within specified warranty period.
1. Failures include, but are not limited to, the following:
 - a. Structural failures including, but not limited to, excessive deflection.
 - b. Noise or vibration created by wind and thermal and structural movements.
 - c. Deterioration of metals, metal finishes, and other materials beyond normal weathering.
 - d. Water penetration through fixed glazing and framing areas.
 - e. Failure of operating components.
 2. Warranty Period: 10 years from date of Substantial Completion.
- B. Special Finish Warranty: Standard form in which manufacturer agrees to repair finishes or replace aluminum that shows evidence of deterioration of factory-applied finishes within specified warranty period.
1. Deterioration includes, but is not limited to, the following:
 - a. Color fading more than 5 Hunter units when tested according to ASTM D 2244.
 - b. Chalking in excess of a No. 8 rating when tested according to ASTM D 4214.
 - c. Cracking, checking, peeling, or failure of paint to adhere to bare metal.
 2. Warranty Period: 10 years from date of Substantial Completion.

PART 2 - PRODUCTS

2.1 PERFORMANCE REQUIREMENTS

- A. Delegated Design: Engage a qualified professional engineer, as defined in Section 01400 "Quality Requirements," to design glazed aluminum curtain walls.
- B. General Performance: Comply with performance requirements specified, as determined by testing of glazed aluminum curtain walls representing those indicated for this Project without failure due to defective manufacture, fabrication, installation, or other defects in construction.
1. Glazed aluminum curtain walls shall withstand movements of supporting structure including, but not limited to, story drift, twist, column shortening, long-term creep, and deflection from uniformly distributed and concentrated live loads.
 2. Failure also includes the following:
 - a. Thermal stresses transferring to building structure.
 - b. Glass breakage.
 - c. Noise or vibration created by wind and thermal and structural movements.
 - d. Loosening or weakening of fasteners, attachments, and other components.

- e. Failure of operating units.
- C. Structural Loads:
 - 1. Wind Loads: As indicated on Structural Drawings.
 - 2. Other Design Loads: As indicated in Construction documents / Structural Drawings.
- D. Deflection of Framing Members: At design wind pressure, as follows:
 - 1. Deflection Parallel to Glazing Plane: Limited to amount not exceeding that which reduces glazing bite to less than 75 percent of design dimension and that which reduces edge clearance between framing members and glazing or other fixed components to less than 1/8 inch (3.2 mm).
 - a. Operable Units: Provide a minimum 1/16-inch (1.6-mm) clearance between framing members and operable units.
- E. Structural: Test according to ASTM E 330 as follows:
 - 1. When tested at positive and negative wind-load design pressures, assemblies do not evidence deflection exceeding specified limits.
 - 2. When tested at 150 percent of positive and negative wind-load design pressures, assemblies, including anchorage, do not evidence material failures, structural distress, or permanent deformation of main framing members exceeding 0.2 percent of span.
 - 3. Test Durations: As required by design wind velocity, but not less than 10 seconds.
- F. Air Infiltration: Test according to ASTM E 283 for infiltration as follows:
 - 1. Fixed Framing and Glass Area:
 - a. Maximum air leakage of 0.06 cfm/sq. ft. (0.30 L/s per sq. m) at a static-air-pressure differential of 6.24 lbf/sq. ft. (300 Pa).
- G. Water Penetration under Static Pressure: Test according to ASTM E 331 as follows:
 - 1. No evidence of water penetration through fixed glazing and framing areas when tested according to a minimum static-air-pressure differential of 20 percent of positive wind-load design pressure, but not less than 15 lbf/sq. ft. (720 Pa).
- H. Water Penetration under Dynamic Pressure: Test according to AAMA 501.1 as follows:
 - 1. No evidence of water penetration through fixed glazing and framing areas when tested at dynamic pressure equal to 20 percent of positive wind-load design pressure, but not less than 15 lbf/sq. ft. (720 Pa).
 - 2. Maximum Water Leakage: No uncontrolled water penetrating assemblies or water appearing on assemblies' normally exposed interior surfaces from sources other than condensation. Water leakage does not include water controlled by flashing and gutters, or water that is drained to exterior.
- I. Seismic Performance: Glazed aluminum curtain walls shall withstand the effects of earthquake motions determined according to ASCE/SEI 7.
 - 1. Seismic Drift Causing Glass Fallout: Complying with criteria for passing based on building occupancy type when tested according to AAMA 501.6 at design displacement and 1.5 times the design displacement.
- J. Energy Performance: Certify and label energy performance according to NFRC as follows:
 - 1. Thermal Transmittance (U-factor): Fixed glazing and framing areas shall have U-factor of not more than 0.57 Btu/sq. ft. x h x deg F (3.23 W/sq. m x K) as determined according to NFRC 100.
 - 2. Solar Heat Gain Coefficient: Fixed glazing and framing areas shall have a solar heat gain coefficient of no greater than 0.61 as determined according to NFRC 200.
 - 3. Condensation Resistance: Fixed glazing and framing areas shall have an NFRC-certified condensation resistance rating of no less than 35 as determined according to NFRC 500.
- K. Noise Reduction: Test according to ASTM E 90, with ratings determined by ASTM E 1332, as follows:
 - 1. Outdoor-Indoor Transmission Class: Minimum 26.
- L. Blast Resistance:
 - 1. Hazard Rating: per ASTM F 1642 for AHJ
 - 2. Performance Condition: per GSA-TS01 for AHJ
- M. Windborne-Debris Impact Resistance: Pass missile-impact and cyclic-pressure tests when tested according to ASTM E 1886 and testing information in ASTM E 1996 for FEMA Wind Zone 4.
 - 1. Large-Missile Test: For glazed openings located within 30 feet (9.1 m) of grade.
 - 2. Small-Missile Test: For glazed openings located more than 30 feet (9.1 m) above grade.
- N. Thermal Movements: Allow for thermal movements resulting from ambient and surface temperature changes:
 - 1. Temperature Change: 120 deg F (67 deg C), ambient; 180 deg F (100 deg C), material surfaces.
 - 2. Thermal Cycling: No buckling; stress on glass; sealant failure; excess stress on framing, anchors, and fasteners; or reduction of performance when tested according to AAMA 501.5.
 - a. High Exterior Ambient-Air Temperature: That which produces an exterior metal-surface temperature of 180 deg F (82 deg C).

- b. Low Exterior Ambient-Air Temperature: 0 deg F (minus 18 deg C).

2.2 MANUFACTURERS

- A. Kawneer North America; an Alcoa company.
 1. Basis of Design:
 - a. Kawneer Curtain Wall: 1600 - Wall System 3
- B. Coral Industries, Inc
- C. Tubelite Inc.
- D. YKK AP America Inc.
- E. Source Limitations: Obtain all components of curtain wall system, including framing spandrel panels entrances and accessories, from single manufacturer.

2.3 FRAMING

- A. Framing Members: Manufacturer's extruded- or formed-aluminum framing members of thickness required and reinforced as required to support imposed loads.
 1. Construction: Thermally broken.
 2. Glazing System: Retained mechanically with gaskets on four sides.
 3. Glazing Plane: Front.
 4. Finish: Clear anodic finish .
 5. Fabrication Method: Either factory- or field-fabricated system.
- B. Pressure Caps: Manufacturer's standard aluminum components that mechanically retain glazing.
 1. Include snap-on aluminum trim that conceals fasteners.
- C. Brackets and Reinforcements: Manufacturer's standard high-strength aluminum with nonstaining, nonferrous shims for aligning system components.
- D. Materials:
 1. Aluminum: Alloy and temper recommended by manufacturer for type of use and finish indicated.
 - a. Sheet and Plate: ASTM B 209 (ASTM B 209M).
 - b. Extruded Bars, Rods, Profiles, and Tubes: ASTM B 221 (ASTM B 221M).
 - c. Extruded Structural Pipe and Tubes: ASTM B 429/B 429M.
 - d. Structural Profiles: ASTM B 308/B 308M.
 2. Steel Reinforcement: Manufacturer's standard zinc-rich, corrosion-resistant primer complying with SSPC-PS Guide No. 12.00; applied immediately after surface preparation and pretreatment. Select surface preparation methods according to recommendations in SSPC-SP COM, and prepare surfaces according to applicable SSPC standard.
 - a. Structural Shapes, Plates, and Bars: ASTM A 36/A 36M.
 - b. Cold-Rolled Sheet and Strip: ASTM A 1008/A 1008M.
 - c. Hot-Rolled Sheet and Strip: ASTM A 1011/A 1011M.

2.4 ENTRANCES

- A. Entrances: Comply with Section 084113 "Aluminum-Framed Entrances and Storefronts."

2.5 GLAZING

- A. Glazing: Comply with Section 088000 "Glazing."
- B. Glazing Gaskets: Manufacturer's standard sealed-corner pressure-glazing system of black, resilient elastomeric glazing gaskets, setting blocks, and shims or spacers.
- C. Glazing Sealants: As recommended by manufacturer.
- D. Sealants used inside the weatherproofing system shall have a VOC content of 250 g/L or less.
- E. Weatherseal Sealants: ASTM C 920 for Type S; Grade NS; Class 25; Uses NT, G, A, and O; chemically curing silicone formulation that is compatible with structural sealant and other system components with which it comes in contact; recommended by structural-sealant, weatherseal-sealant, and structural-sealant-glazed curtain-wall manufacturers for this use.
 1. Color: Match structural sealant.

2.6 ACCESSORIES

- A. Fasteners and Accessories: Manufacturer's standard corrosion-resistant, nonstaining, nonbleeding fasteners and accessories compatible with adjacent materials.

1. Use self-locking devices where fasteners are subject to loosening or turning out from thermal and structural movements, wind loads, or vibration.
2. Reinforce members as required to receive fastener threads.
3. Use exposed fasteners with countersunk Phillips screw heads, finished to match framing system.
- B. Anchors: Three-way adjustable anchors with minimum adjustment of 1 inch (25.4 mm) that accommodate fabrication and installation tolerances in material and finish compatible with adjoining materials and recommended by manufacturer.
 1. Concrete and Masonry Inserts: Hot-dip galvanized cast-iron, malleable-iron, or steel inserts complying with ASTM A 123/A 123M or ASTM A 153/A 153M requirements.
- C. Concealed Flashing: Manufacturer's standard corrosion-resistant, nonstaining, nonbleeding flashing compatible with adjacent materials.
- D. Bituminous Paint: Cold-applied asphalt-mastic paint complying with SSPC-Paint 12 requirements except containing no asbestos, formulated for 30-mil (0.762-mm) thickness per coat.

2.7 FABRICATION

- A. Form or extrude aluminum shapes before finishing.
- B. Weld in concealed locations to greatest extent possible to minimize distortion or discoloration of finish. Remove weld spatter and welding oxides from exposed surfaces by descaling or grinding.
- C. Fabricate components that, when assembled, have the following characteristics:
 1. Profiles that are sharp, straight, and free of defects or deformations.
 2. Accurately fitted joints with ends coped or mitered.
 3. Physical and thermal isolation of glazing from framing members.
 4. Accommodations for thermal and mechanical movements of glazing and framing to maintain required glazing edge clearances.
 5. Provisions for field replacement of glazing from interior.
 6. Fasteners, anchors, and connection devices that are concealed from view to greatest extent possible.
- D. Fabricate components to resist water penetration as follows:
 1. Internal guttering system or other means to drain water passing joints, condensation occurring within framing members, and moisture migrating within glazed aluminum curtain wall to exterior.
- E. Curtain-Wall Framing: Fabricate components for assembly using manufacturer's standard assembly method.
- F. Factory-Assembled Frame Units:
 1. Rigidly secure nonmovement joints.
 2. Prepare surfaces that are in contact structural sealant according to sealant manufacturer's written instructions to ensure compatibility and adhesion.
 3. Preparation includes, but is not limited to, cleaning and priming surfaces.
 4. Seal joints watertight unless otherwise indicated.
 5. Install glazing to comply with requirements in Section 08800 "Glazing."
- G. After fabrication, clearly mark components to identify their locations in Project according to Shop Drawings.

2.8 ALUMINUM FINISHES

- A. Clear Anodic Finish: AAMA 611, AA-M12C22A41, Class I, 0.018 mm or thicker.

2.9 SOURCE QUALITY CONTROL

- A. Structural Sealant: Perform quality-control procedures complying with ASTM C 1401 recommendations including, but not limited to, assembly material qualification procedures, sealant testing, and assembly fabrication reviews and checks.

PART 3 - EXECUTION

3.1 EXAMINATION

- A. Examine areas, with Installer present, for compliance with requirements for installation tolerances and other conditions affecting performance of the Work.
- B. Proceed with installation only after unsatisfactory conditions have been corrected.

3.2 PREPARATION

- A. Prepare surfaces that will contact structural sealant according to sealant manufacturer's written instructions to ensure compatibility and adhesion. Preparation includes, but is not limited to, cleaning and priming surfaces.

3.3 INSTALLATION**A. General:**

1. Comply with manufacturer's written instructions.
2. Do not install damaged components.
3. Fit joints to produce hairline joints free of burrs and distortion.
4. Rigidly secure nonmovement joints.
5. Install anchors with separators and isolators to prevent metal corrosion and electrolytic deterioration and to prevent impeding movement of moving joints.
6. Where welding is required, weld components in concealed locations to minimize distortion or discoloration of finish. Protect glazing surfaces from welding.
7. Seal joints watertight unless otherwise indicated.

B. Metal Protection:

1. Where aluminum is in contact with dissimilar metals, protect against galvanic action by painting contact surfaces with primer, applying sealant or tape, or installing nonconductive spacers as recommended by manufacturer for this purpose.
2. Where aluminum is in contact concrete or masonry, protect against corrosion by painting contact surfaces with bituminous paint.

C. Install components to drain water passing joints, condensation occurring within framing members, and moisture migrating within glazed aluminum curtain wall to exterior.**D. Install components plumb and true in alignment with established lines and grades.****E. Install glazing as specified in Section 08800 "Glazing."**

1. Prepare surfaces that will contact structural sealant according to sealant manufacturer's written instructions to ensure compatibility and adhesion. Preparation includes, but is not limited to, cleaning and priming surfaces.

3.4 ERECTION TOLERANCES**A. Erection Tolerances: Install glazed aluminum curtain walls to comply with the following maximum tolerances:**

1. Plumb: 1/8 inch in 10 feet (3.2 mm in 3 m); 1/4 inch in 40 feet (6.35 mm in 12.2 m).
2. Level: 1/8 inch in 20 feet (3.2 mm in 6 m); 1/4 inch in 40 feet (6.35 mm in 12.2 m).
3. Alignment:
 - a. Where surfaces abut in line or are separated by reveal or protruding element up to 1/2 inch (12.7 mm) wide, limit offset from true alignment to 1/16 inch (1.6 mm).
 - b. Where surfaces are separated by reveal or protruding element from 1/2 to 1 inch (12.7 to 25.4 mm) wide, limit offset from true alignment to 1/8 inch (3.2 mm).
 - c. Where surfaces are separated by reveal or protruding element of 1 inch (25.4 mm) wide or more, limit offset from true alignment to 1/4 inch (6 mm).
4. Location: Limit variation from plane to 1/8 inch in 12 feet (3.2 mm in 3.6 m); 1/2 inch (12.7 mm) over total length.

END OF SECTION 084423

CURTAIN WALL
VERTICAL
MEMBER BYPASSING
STEEL BRIDGING

FILL JOINT
WITH SEALANT

FILLER PANEL
W/ RECEIVER
FOR CAULK JOINT

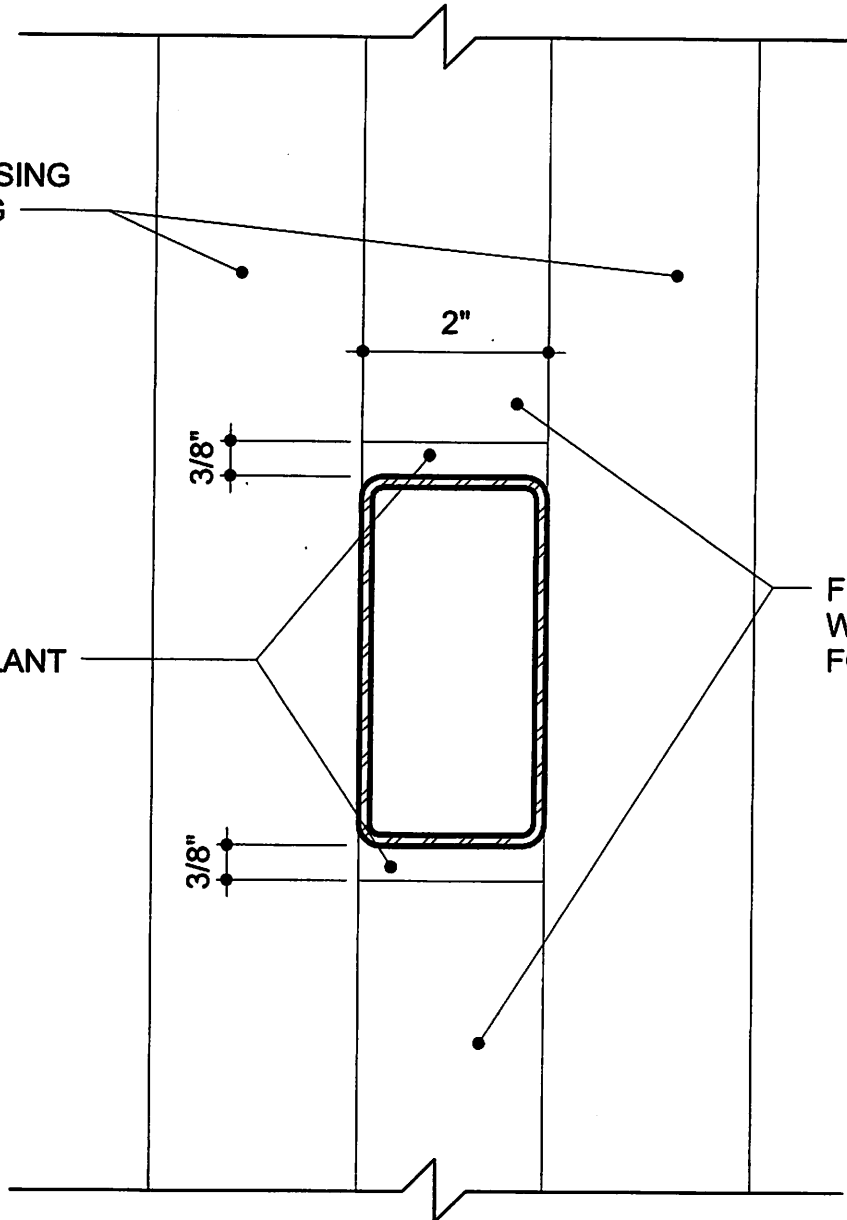

1

**CURTAIN WALL
PENETRATION**

SCALE: 6" = 1'-0"

JOB NO.: 13-073

DATE: 03/27/17

REVISIONS:

SD-5

**WARD
SCOTT**
ARCHITECTURE

2715 Seventh Street
Tuscaloosa, AL 35401
www.ward-scott.com



THE EDGE BUSINESS
THE CITY OF TUSCALOOSA
2627 10TH AVENUE,
TUSCALOOSA, ALABAMA

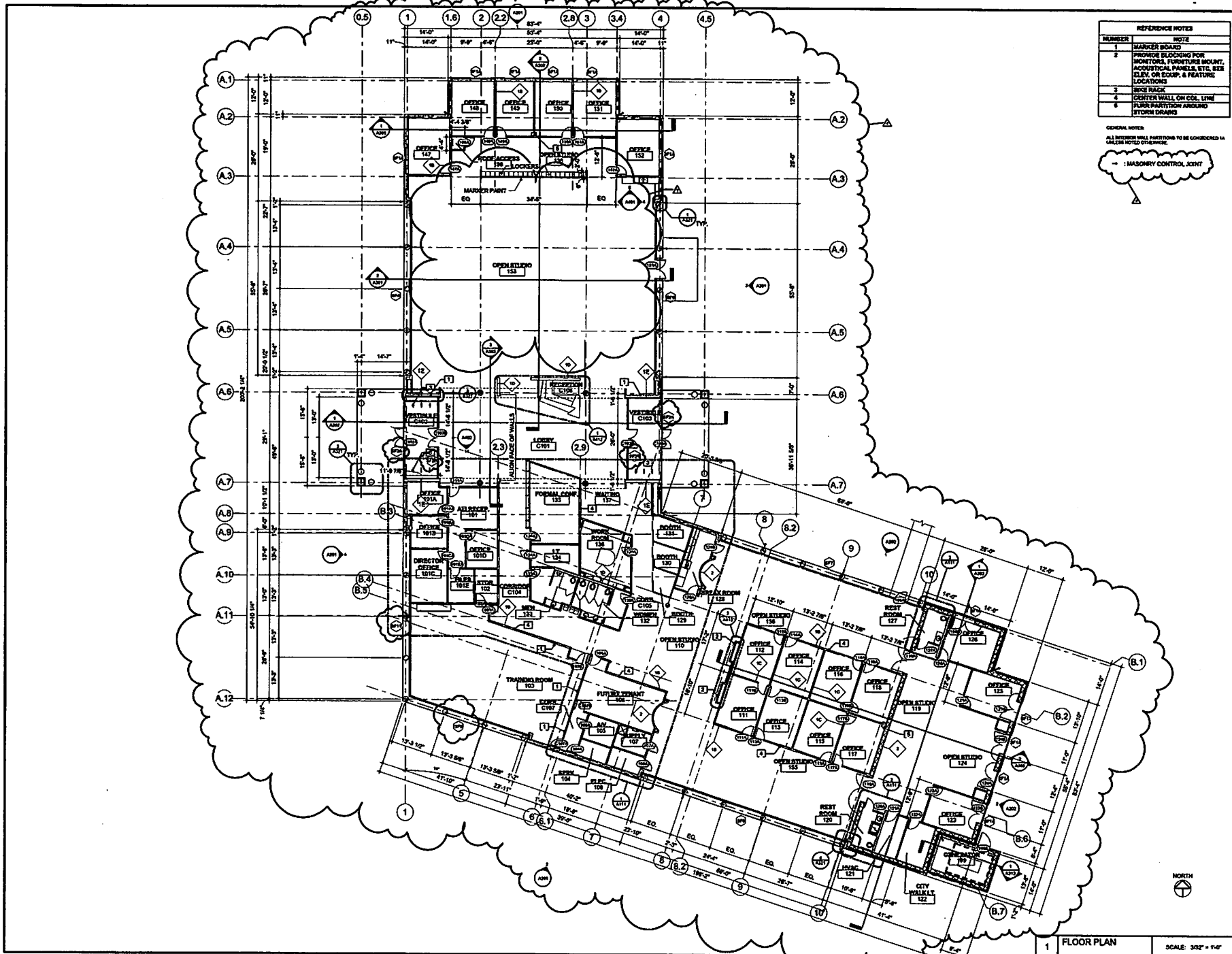

REFERENCE NOTES	
NUMBER	NOTE
1	MARKER BOARD
2	PROMOTE BLOCKING FOR MONITORS, FURNITURE MOUNT, ACOUSTICAL PANELS, ETC. SEE ELEV. OR E.O.P. & FEATURE LOCATIONS
3	WIRE RACK
4	CENTER WALL ON COIL LINE
5	FURN. PARTITION AROUND STORM DRAINS

GENERAL NOTES
 ALL INTERIOR WALL PARTITIONS TO BE CONSIDERED IN GALENS NOTED OTHERWISE.
 : MASONRY CONTROL JOINT

WARD SCOTT ARCHITECTS
 5715 S. Grand Street
 Tuscaloosa, AL 35401
 www.ward-scott.com



THE EDGE BUSINESS RESOURCE CENTER
 THE CITY OF TUSCALOOSA
 2627 10TH AVENUE,
 TUSCALOOSA, ALABAMA

CONSTRUCTION DOCUMENTS		
DATE:	1-30-15	
PROJ. NO.:	13-073	
REVISIONS		
#	DESC	DATE
1	ADDENDUM M.B.	02/17/17
2	ADDENDUM M.B.	02/17/17
3	ADDENDUM M.B.	02/17/17

FLOOR PLAN



ADDENDUM NO. 6:

Date: March 29, 2017
Project: The EDGE Business Resource Center
Owner: The City of Tuscaloosa
Owner's Project No: A16-1320 (Previously City #A14-1210)
Architect: Ward Scott Architecture, Inc.

This Addendum forms a part of the Contract Documents and modifies the original Bid Documents dated July 30, 2015, as noted below.

Acknowledge receipt of this Addendum in the location provided on the Bid Proposal Form.

1.1 GENERAL

A. N/A

1.2 SPECIFICATIONS AND DRAWINGS

A. Specifications:

1. Refer to Trade Package Summaries of Work

a. EDGE – 02 General Trade Package will no longer be responsible for these items. Add the following at Scope of Work Item #51.:

51. This Trade Contractor shall provide and install the trench drains units at the patio area as indicated on Sheet AC03.

1.3 ATTACHED TO ADDENDUM

A. N/A

END OF ADDENDUM



ADDENDUM NO. 7:

Date: March 29, 2017
Project: The EDGE Business Resource Center
Owner: The City of Tuscaloosa
Owner's Project No: A16-1320 (Previously City #A14-1210)
Architect: Ward Scott Architecture, Inc.

This Addendum forms a part of the Contract Documents and modifies the original Bid Documents dated July 30, 2015, as noted below.

Acknowledge receipt of this Addendum in the location provided on the Bid Proposal Form.

1.1 GENERAL

A. Refer to attached BKI Addendum and Unit Price Schedule.

1.2 SPECIFICATIONS AND DRAWINGS

A. Specifications:

1. Refer to Trade Package Summaries of Work

a. EDGE – 02 General Trade Package. Add the following at Scope of Work Item #51.:

51. This Trade Contractor shall provide and install the trench drains units at the patio area as indicated on Sheet AC03.

1) This shall supersede Addendum 6 Item #: 1.2.A.1.a.

1.3 ATTACHED TO ADDENDUM

A. BKI Addendum and Unit Price Schedule

END OF ADDENDUM

BURK-KLEINPETER, INC.

ENGINEERS, ARCHITECTS, PLANNERS, ENVIRONMENTAL SCIENTISTS
2900 8TH STREET
TUSCALOOSA, AL 35401
PHONE (205) 759-3221 FAX (205) 759-9166

ADDENDUM NO. 7

The EDGE Business Resource Center City of Tuscaloosa Project No. A16-1320 March 29, 2017

This addendum forms a part of the Contract Documents and modifies the original Bidding Documents dated July 30, 2015.

ITEM NO. 1 – REVISION UNIT PRICE SCHEDULE:

Replace the Unit Price Schedule for Sitework found within the Contract Documents in its entirety with the attached. Review the revised Unit Price Schedule dated March 29, 2017. An item has been added for "Contingency Allowance".

ITEM NO. 2 – CLARIFICATION WATER SYSTEM IMPROVEMENTS UNIT PRICES:

The City of Tuscaloosa Water Department will provide the water meters and double check detector assembly listed as part of Item Nos. 44 - 46 on the Unit Price Schedule. The contractor is responsible for providing all other materials, labor, equipment, tools, incidentals, etc. necessary to install these items, including but not limited to curb stops, backflow preventers, meter boxes and concrete vaults.

Attachments:

1. Unit Price Schedule for Sitework

END OF ADDENDUM NO. 7



City of Tuscaloosa
The EDGE Business Resource Center

Sitework Unit Price Schedule

March 29, 2017

PREPARED BY: BURK-KLEINPETER, INC.

ITEM NO.	APPROX. QTY.	UNIT	ITEM DESCRIPTION	UNIT PRICE	AMOUNT
BASE BID ITEMS					
General, Demolition, Clearing, Grubbing, and Earthwork					
1	1	LS	Demolition, Clearing & Grubbing (Approx. 5 Acres)		
2	650	LF	Remove Existing Piping		
3	4	Each	Remove Existing Storm/Sanitary Structure		
4	2	Each	Plug & Abandon Existing Pipe		
5	1,800	LF	Remove Existing Fence		
6	5,155	SY	Remove Existing Pavements (Asphalt & Concrete)		
7	1	LS	Earthwork		
8	11,500	CYIP	Removal of Unsuitable Material (Only as Directed by the Owner's Representative)		
9	11,500	CYIP	Off-Site Borrow - Select for Unsuitable Material Replacement		
Base, Pave, and Curb and Gutter Improvements					
10	4,600	SY	Roadbed Processing (Only as Directed by the Owner's Representative)		
11	1,240	SY	Crushed Aggregate Base Course, ALDOT 825B, Plant Mixed, 4" Compacted Thickness		
12	4,290	SY	Crushed Aggregate Base Course, ALDOT 825B, Plant Mixed, 6" Compacted Thickness		
13	4,600	SY	Bituminous Treatment A		
14	385	Gal	Tack Coat		
15	620	SY	Milling Existing Pavement		
16	240	Ton	Superpave Bituminous Concrete Wearing Surface Layer, 1/2" Maximum Aggregate Size Mix, ESAL Range A/B		
17	425	Ton	Superpave Bituminous Concrete Upper Binder Layer, 1" Maximum Aggregate Size Mix, ESAL Range A/B		
18	1,235	SY	Concrete Pavement, 6" Thick Installed		
19	2,350	LF	Type C Combination Curb & Gutter (1.5' Width) Installed		
20	665	LF	Type C Combination Curb & Gutter (2' Width) Installed		
21	120	LF	Valley Gutter Installed		
22	1,310	SY	Concrete Sidewalk, 4" Thick w/ Stone Installed		
23	5	Each	Truncated Domes Installed		
24	3	Each	Parking Stops		
Storm Drain System Improvements					
25	238	LF	12" PVC Storm Pipe, SDR 26 Installed		
26	336	LF	15" HDPE, N-12 Installed		
27	360	LF	15" R.C. Pipe, Class 3 Installed		
28	957	LF	18" R.C. Pipe, Class 3 Installed		
29	1	Each	Junction Box Installed		
30	4	Each	S-Inlet (1-Wing) Installed		

ITEM NO.	APPROX. QTY.	UNIT	ITEM DESCRIPTION	UNIT PRICE	AMOUNT
31	1	Each	S-Inlet (2-Wing) Installed		
32	4	Each	Yard Inlet Installed		
33	4	Each	24" Drain Basin and Grate Installed		
34	1	Each	24" Drain Basin and Solid Cover Installed		
35	3	Each	Slope Paved Headwall Installed		
Sanitary Sewer System Improvements					
36	190	LF	4" PVC Pipe, SDR 26, Sanitary Sewer Lateral Installed		
37	1	Each	8" X 4" Sanitary Sewer Wye (Tie to Existing Main) Installed		
38	2	Each	Sanitary Sewer Cleanout w/ Required Wyes Installed		
Water System Improvements					
39	188	LF	2" PVC Pipe, Class 200, Water Service Line Installed		
40	76	LF	6" DI Class 350 Water Main Installed		
41	1	Each	2" Watermain Service Tap Installed		
42	1	Each	6" Hot Tap w/ 4" Tapping Valve & Sleeve Installed		
43	1	Each	6" Hot Tap w/ 6" Tapping Valve & Sleeve Installed		
44	1	Each	1-1/2" Domestic Meter, Backflow Preventer & Meter Box Installed		
45	1	Each	2" Irrigation Meter, Backflow Preventer & Meter Box Installed		
46	1	Each	6" Double Check Detector Assembly & Vault Installed		
47	1	Each	Siamese Post Connection & Vault Installed		
Traffic Control, Permanent Signing and Striping					
48	1	LS	Traffic Control		
49	1,332	LF	Solid White, Class 1, Type B Traffic Stripe (4" Wide) Installed		
50	234	LF	Solid Blue, Class 1, Type B Traffic Stripe (4" Wide) Installed		
51	4	Each	Handicap Symbols (Traffic Control Markings, Class 1, Type B) Installed		
52	155	LF	Solid White Traffic Control Markings, Class 1, Type B (6" Wide) Installed		
53	29	LF	2' Wide Stop Bar (Traffic Control Markings, Class 1, Type B) Installed		
54	6	Each	Permanent Post Mounted Signs		
Erosion Control and Site Maintenance					
55	1	LS	Erosion Control Management and Maintenance		
Miscellaneous Items					
56	500	Ton	ALDOT No. 57 Stone (Only as Directed by the Owner's Representative)		
57	700	CY	Utility Trench Foundation Material (ALDOT No. 2 Stone) (Only as Directed by the Owner's Representative)		
58	6,700	SY	Geotextile Separation Fabric (Miraf, HP570 or Approved Equal)(Only as Directed by the Owner's Representative) Installed		
Allowances					
59	1	LS	Contingency Allowance	\$15,000.00	\$15,000.00
TOTAL BASE BID					
ALTERNATE BID ITEMS					
100	45	LF	Standup Curb		
TOTAL BASE BID + ALTERNATE BID					

Note:
Unit prices shall be compensation in full for furnishing all materials, equipment, tools, labor and incidentals necessary to complete the work. No extra payment will be made for items not specifically called out in a line item on the Unit Price Schedule such as site preparation, saw-cutting, trench excavation, pipe bedding, trench backfill (including stone), asphalt patching for utility trenches, etc. and the cost of these items shall be included in the appropriate unit price listed in the Schedule.

TABLE OF CONTENTS

SECTION	PAGE
TITLE PAGE	i
TABLE OF CONTENTS	ii-vii
SECTION ONE: ADVERTISEMENT AND NOTICE FOR BIDS	1-3
SECTION TWO: INSTRUCTION TO BIDDERS	
Intention	4
Definitions	4-5
Work to be Performed	5
Bidding, Generally	5-6
Responsible, Responsive Bidders	6
Bid Bonds	6-7
Return of Bid Bonds	7
Forfeiture of Bid Bonds	7
Consideration of Bid Proposals	7-8
Materials and Work	8-9
Execution of Contract, Notice to Proceed	9
Labor, Material and Performance Bonds	9
Surety and Insurer Qualifications	9-10
Power-of-Attorney	10
Insurance	10
Examination of Contract Documents and of the Site of the Project	10
Subsurface Reports	10-11
Interpretation of Plans and Specifications	11
General Contractor's Permit or License	11
U. S. Products Preference	11
Use of Domestic Steel	11
In State Bidder Preference	11-12
Applicable Laws	12
SRF/DWSRF Special Requirements	12
Special Conditions for Federally Funded Contracts	12

SECTION	TABLE OF CONTENTS	PAGE
----------------	--------------------------	-------------

Agent's Verification of Insurance	12
Compliance with Immigration Law	12
Compliance with Affordable Health Care Act	12-13
Compliance with the City of Tuscaloosa Minority Enterprise / Disadvantage Business Enterprise (MBE/DBE/WBE) Policy for Public Works Projects Over \$50,000	13
Buy American Clause	13
SECTION THREE: PROPOSAL (BID)	14-19
SECTION FOUR: BID BOND TO THE CITY OF TUSCALOOSA, ALABAMA	20-21
SECTION FIVE: CONTRACT AGREEMENT	
<u>Article I. Generally</u>	
Contract Documents	22
Independent Contractor	22
Order of Precedence	22-23
Integration; Contract Terms and Construction	23
Rules of Construction	24
Construction Manager - Multiple Trade Contracts	24
Coordination of Plans, Specifications, etc.	24
Corrections of Plans, etc.	24
Taxes and Charges	24
Shop Drawings and Submittals	25
Alabama Immigration Law	25
Compliance with Affordable Health Care Act	25
Compliance with Act 2016-312	25
<u>Article II. Payments, Claims, and Charges, Etc.</u>	
Contract Price	25
Estimated Quantities and Unit Prices	25
Overtime Work by Contractor	25-26
Payments on Account/Payments Withheld/Retainage	26-27
Claims for Extra Cost	27
Differing Site Conditions	27

SECTION	TABLE OF CONTENTS	PAGE
----------------	--------------------------	-------------

Change Orders	27-28
Determination of Adjustment of the Contract Sum	28
Construction Schedule and Periodical Estimates	28
Sales and Use Tax Savings	28-29

Article III. Time

Time for Completion/Delays	29
Extensions of Time	29-30
Right of the City to Terminate Contract	30
Liquidated Damages	30

Article IV. Work and Materials

Cooperation of Contractor	31
Coordination - Trade Contractors	31
Superintendence	31
Contractor's Tools and Equipment	31
Furnishing Labor and Equipment	31
Employees	31
Materials and Appliances	32
Asbestos and Hazardous Materials	32
Protection of Work and Property	32-33
Protection of Existing Utilities	33
Limiting Exposures	34
Safety	34-35
Traffic Control	35
Responsibility to Act in Emergency	35
Sanitary Regulations	35
Cutting and Patching, etc.	35-36
Trailers	36
Construction Staking	36
Periodic Cleanup	36-37

SECTION	TABLE OF CONTENTS	PAGE
---------	-------------------	------

Termite Control	37-38
Erosion Control	38
Wastewater Containment and Management Plan	38-39
Environmental Clause/Covenant	39

Article V. Insurance, Liability, Etc.

Contractor's Insurance (Generally)	39-40
Insurance	40-42
No Personal Liability of Public Officials	42
Indemnity	42
Errors and Omissions	42
Exclusion of Contractor Claims	42
Inadequate Surety/Insurance	42-43
Changes	43

Article VI. Observation of the Project

Generally	43
Observation of the Project	43-44
Authority and Duties of Observers	44
Defective Work/Correction of Work by the City	44
Disagreement	44-45
Stop Work Orders	45
Progress Meetings	45

Article VII. Project Completion

Substantial Completion	45
Final Inspection	45-46
"As Built" Drawings	46
Final Cleanup	46
Notice of Completion	46-47
Final Payment	47

SECTION	TABLE OF CONTENTS	PAGE
----------------	--------------------------	-------------

Acceptance of Final Payment Constitutes Release	47
---	----

Article VIII. Warranty and Guarantees

Warranty and Guarantee	48
------------------------	----

Correction of Defective Work During Warranty/Guarantee Period	48-49
---	-------

Article IX. Laws, Permits, Etc.

Laws and Regulations/Royalties, Patents, Copyrights and Permits and Rights-of-Way	49-50
---	-------

Alabama Department of Transportation Rights-of-Way	50
--	----

Tuscaloosa County Right-of-Way	50
--------------------------------	----

Storm Water Permit and Monitoring	50-51
-----------------------------------	-------

Article X. Miscellaneous Clauses

Notice and Service Thereof	52
----------------------------	----

City Representative	52
---------------------	----

Contractor Representative	52
---------------------------	----

Capacity	52-53
----------	-------

Ownership of Contract Documents	53
---------------------------------	----

No Waiver of Rights	53
---------------------	----

Subletting or Assigning of Contract	53-54
-------------------------------------	-------

Third Party Beneficiaries	54
---------------------------	----

Final Integration	54
-------------------	----

Force Majeure	54
---------------	----

Amendment in Writing	54
----------------------	----

Binding Effect	54
----------------	----

Captions	54
----------	----

Construction	54
--------------	----

Mandatory and Permissive	54
--------------------------	----

Governing Laws	54
----------------	----

Liability of the City of City Officials	54
---	----

Non Discrimination	55
--------------------	----

SECTION	TABLE OF CONTENTS	PAGE
Fines and Penalties		55
Agreement Date/Counterparts		55
Use of Words and Phrases		55
Severability		55
SECTION SIX. PERFORMANCE BOND		57
SECTION SEVEN. LABOR AND MATERIAL BOND		58-59
CONTRACTOR'S RELEASE OF LIENS AND CLAIMS		60
ROOFING GUARANTEE		61
ASBESTOS AFFIDAVIT		62
AGENT'S VERIFICATION OF CONTRACTOR'S INSURANCE		63
NOTICE OF CONDITIONAL BID AWARD		64
NOTICE TO PROCEED WITH PUBLIC WORKS PROJECT		65
CONTRACT CHANGE ORDER		66
CONTRACT CHANGE ORDER REQUEST		67-68
NOTICE OF COMPLETION OF PUBLIC WORKS PROJECT		69
SPECIAL CONDITIONS FOR FEDERALLY FUNDED CONTRACTS		70-100
APPLICATION FOR SALES & USE TAX CERTIFICATE OF EXEMPTION		101-103
EXHIBIT A MINORITY ENTERPRISE / DISADVANTAGED BUSINESS ENTERPRISE (MBE/DBE/WBE) POLICY FOR PUBLIC WORKS PROJECTS OVER \$50,000		104-118
EXHIBIT B PRECONSTRUCTION CONFERENCE REQUIREMENTS		119-121
EXHIBIT C U.S. DEPARTMENT OF LABOR – PAYROLL		122-123
EXHIBIT D OSHA FACT SHEET		124-125
EXHIBIT E EMPLOYEE RIGHTS UNDER THE DAVIS-BACON ACT		126
EXHIBIT F DAVIS-BACON AND RELATED ACTS		127-145
EXHIBIT G RECORD OF EMPLOYEE INTERVIEW		146
EXHIBIT H EDA SITE SIGN SPECIFICATIONS		147-151
EXHIBIT I EDA-EXECUTED CONTRACTED DOCUMENT CHECKLIST		152
EXHIBIT J CERTIFICATION REGARDING LOBBYING		153
EXHIBIT K CERTIFICATIONS REGARDING DEBARMENT, SUSPENSION, INELIGIBILITY AND VOLUNTARY EXCLUSION-LOWER TIER COVERED TRANSACTIONS AND LOBBYING		154

STATE OF ALABAMA)
TUSCALOOSA COUNTY)
CITY OF TUSCALOOSA)

CITY OF TUSCALOOSA PUBLIC WORKS CONTRACT DOCUMENTS

SECTION ONE
ADVERTISEMENT AND NOTICE FOR BIDS
(2017)

Sealed bids will be received by the City of Tuscaloosa, Alabama, a Municipal Corporation, in the Council Chamber in the City Hall, 2201 University Boulevard, on the 23rd day of March, 2017, until 2:00, p.m., o'clock, local time, and then publicly opened and read for the furnishing of all labor and material (where required) and equipment for performing a public works project according to the plans, details, specifications and Contract Documents.

Award of the contract will be made within forty-five (45) calendar days from the date of the bid opening.

1. The Project:

A. The Project shall be known as The EDGE Business Resource Center and the general character of said public works project shall consist of the following:

A new 26,300 square foot business incubator consisting of open concept office space, private offices, meeting rooms and support spaces. The building consists of a steel frame with masonry veneer. The building includes a storm shelter.

B. The approximate quantities of said Project are as follows: Refer to Construction Documents

C. Special instructions are as follows: N/A

D. The City will furnish the following: N/A

E. Time of Construction: From the date stated in the Notice to Proceed, the Project time of construction is Four Hundred Thirty-Five consecutive calendar days.

2. Plans and Specifications:

Plans and specifications and all related Contract Documents are open for public inspection at the office of Ward Scott Architecture, located at 2715 7th Street, Tuscaloosa, Alabama, or the Construction Manager, Harrison Construction, 5870 Charlie Shirley Road, Northport, Alabama, and plans, specifications and other elements of the contract documents may be obtained from TuscaBlue, 1926 University Boulevard, Tuscaloosa Alabama, as designated as the office of the awarding authority for this purpose, located at Tuscaloosa, Alabama. The contact person for the project is Jordan Morris. They can be reached at Ward Scott Architecture, 2715 7th Street, Tuscaloosa.

A. Plans, specifications and Contract Documents may be obtained at the above location upon the deposit of \$ 200.00, which amount does not exceed twice the cost of printing, reproduction, handling and distribution of each set of such documents. Deposits by prime Contractor bidders are refundable in full upon return of all documents in reusable condition within ten (10) days of bid opening. Additional sets of bid documents for prime Contractor bidders, subcontractors, vendors or dealers

may be obtained upon payment of the same deposit. Such deposits will be refunded, less the cost of printing, reproduction, handling and distribution, if all the documents are returned in reusable condition within ten (10) days of bid opening.

- B. All eligible refunds of deposits for plans and specifications will be made by the City within twenty (20) days of bid opening.

3. Qualification of Bidders:

- A. All bidders must be responsible, meeting the criteria and requirements set forth in the Instructions to Bidders and bid proposal.
- B. Prequalification of Bidders IS _____ ; IS NOT X required.
If prequalification of bidders is indicated to be required by the preceding sentence, then written prequalification information is available for review at the same office where plans, specifications and Contract Documents are available.
- C. The attention of all bidders is called to the provisions of State law governing "general Contractors," as set forth in Ala. Code §34-8-1, et seq. (1975), and rules and regulations promulgated pursuant thereto.
- D. If a construction manager is being utilized and this contract is one of a multiple of trade contracts, then the bidder shall be fully licensed for the trade, as determined by applicable law.
- E. The City may not enter into a contract with a non-resident corporation or entity which is not qualified under State law to do business in the State of Alabama.
- F. All bidders shall possess all other licenses and/or permits required by applicable law, rule or regulation for the performance of the work.
- G. All bidders must submit with their proposal, Contractor's license number and a copy of the license. State law, Ala. Code §34-8-8(b), requires all bids to be rejected which do not contain the General Contractor's current license number.
- H. The City reserves the right to reject all bids and/or reject and rebid the Project should it determine the same is in the best interest of the City.

4. Construction Manager:

- X If the preceding blank is marked with an affirmative indication, it means that this contract involves the use of a construction manager and this contract is one of several multiple trade and/or multiple prime contracts for work on the Project. Bidders attention is called to the supplemental conditions attached to the General Conditions of the Contract Documents regarding this topic.

5. Bid Bonds: Each bidder must submit with its bid a cashier's check drawn on an Alabama bank or a fully executed bid bond on the form that is contained in the Contract Documents executed by a surety company duly authorized and qualified to make bond in the State of Alabama. All bonds, sureties and/or cashier checks will be made payable to the City for an amount not less than 5 percent of the City's or its engineers or architects estimated cost of the Project or of the total bid in the proposal, but in no event more than \$50,000.00. Provided, however, Federal Procurement Standards will prevail if conflicts arise with this provision in reference to Ala. Code § 41-16-50 through 41-16-63 and § 39-2-4, as amended, through the 1981 Regular Session as it relates to the "bid guarantee."

6. Sales and Use Tax Savings: Alabama Department of Revenue Rule 810-6-3.69.02(2010) exempts certain payment of state, county, and municipal sales and use taxes by the contractor or subcontractor on tangible personal property to be incorporated into the realty pursuant to a contract with a municipal corporation such as the City of Tuscaloosa. All tax exempt purchases shall be in accordance with the laws of this state and the Alabama Department of Revenue. It is the sole responsibility of the successful contractor to make the necessary inquiries and determinations as to what materials or items of tangible personal property to be incorporated into the project qualify as tax exempt in

the opinion of the Alabama Department of Revenue. Unless otherwise noted, the project will be bid and administered in compliance with the State of Alabama Act 2013-205, Certificate of Exemption from Sales and Use Tax for Governmental Entities, regarding sales and use taxes. Sales and use taxes shall not be included in the bid. The Contractor shall be responsible for obtaining a certificate of exemption from the Alabama Department of Revenue for purchases of materials and other tangible property made part of the project. Any subcontractors purchasing materials or other tangible personal property as part of the project shall also be responsible for obtaining a certificate of exemption. The estimate sales and use tax saving must be accounted for on the bid proposal. Failure to provide the estimated sales and use tax savings may render the bid as non-responsive. Other than determining responsiveness of the bid, sales and use tax accounting shall not affect the bid pricing nor shall be considered in the determination of the lowest responsible and responsive bidder.

7. Pre-Bid Conference: A Mandatory Pre-Bid Conference IS X IS NOT _____ required for this Project. The pre-bid Conference will be held March 8, 2017 at 10:00 a.m. in the Tuscaloosa City Hall Council Chambers.

NOTE: All bidders are advised to carefully read the Instructions to Bidders contained in the Contract Documents, which provisions and requirements are adopted herein by reference.

CITY OF TUSCALOOSA, ALABAMA,
A MUNICIPAL CORPORATION
Walter Maddox, Mayor

[END ADVERTISEMENT FOR BID—OFFICE OF THE CITY ATTORNEY]

CITY OF TUSCALOOSA PUBLIC WORKS CONTRACT DOCUMENTS
SECTION TWO
INSTRUCTION TO BIDDERS
(2017)

NOTE: THIS DOCUMENT CONTAINS IMPORTANT BIDDING AND CONTRACTING INFORMATION. ALL POTENTIAL BIDDERS SHOULD READ IT THOROUGHLY

1. **Intention:** The Advertisement for Bids, Instruction to Bidders, Contract Agreement, any modifications or supplemental conditions to the Contract Agreement, Bid Proposal, and the Plans and Specifications are interrelated and apply to the complete work to which they relate.

2. **Definitions:** Where the following words, or the pronouns used in their stead, occur herein, they shall have the following meaning:

"Awarding Authority" shall mean the City of Tuscaloosa, Alabama.

"Bidder" shall mean any person, firm or corporation, that is responsible, submitting a responsive bid for the Project contemplated by the contract documents, who meets the requirements set forth in the contract documents, maintains a permanent place of business, has adequate forces and equipment to perform the work on the Project properly and within the time limit that is established, has sufficient experience in the type work provided for in the contract documents and has adequate financial status and resources to meet its obligations contingent to the work.

"City" or "Owner" shall mean the City of Tuscaloosa, Alabama, as the awarding authority or its authorized and legal representatives.

"Construction Manager" shall mean that person or entity employed by the City to provide Construction Manager services on the work or Project, who shall be the City's representative on the Project.

"Contractor" shall mean initially the successful or probable low bidder and then the party of the first part to the construction agreement or the legally authorized representatives of such party, including a trade contractor.

"Engineer/Architect" shall mean an Engineer or Architect responsible for design and related services on the Project, and if no Construction Manager is employed, then the Engineer is the representative of the City of Tuscaloosa, Alabama, on the Project. References to the "Engineer" shall mean the Construction Manager, if the City has employed such services, to the extent such services are applicable to construction management activity as set forth in the agreement between the City and the Construction Manager, and the context herein indicates that it would relate to services traditionally and customarily performed by a Construction Manager; otherwise, "Engineer" shall refer to the Engineer or Architect.

"Force Account Work" work paid for by reimbursing for the actual cost for labor, materials and equipment usage incurred in the performance of the work, as directed, including a percentage for overhead and profit where appropriate.

"Gender": a word importing one gender shall if appropriate extend to and be applied to the other gender. The masculine shall include the feminine and vice versa, unless the context clearly indicates otherwise.

"Inspector" shall mean a representative of the Engineer/Architect, Construction Manager or the City, as the case may be.

"Non-Resident Contractor" shall mean a contractor which is neither (a) organized and existing under the laws of the State of Alabama nor (b) maintains its principal place of business in the State of Alabama. A non-

resident contractor which has maintained a permanent branch office within the State of Alabama for at least five (5) continuous years shall not thereafter be deemed to be a non-resident contractor so long as the contractor continues to maintain a branch office within Alabama.

"Project" shall mean the Public Work to which these Contract Documents relate, including the labor, materials and all work to be done by Contractor that is the subject of the bid, plans, specifications and contract documents.

"Public Property" Real property which the awarding authority owns or has contractual right to own or purchase, including easements, rights-of-way, or otherwise.

"Public Work(s)" shall mean a Project consisting of the construction, repair, renovation, or maintenance of public buildings, structures, sewers, water works, roads, bridges, docks, underpasses and viaducts, as well as any other improvement to be constructed, repaired or renovated or maintained on public property to be paid, in whole or in part, with public funds or with financing to be retired with public funds in the form of lease payments or otherwise.

"Responsible Bidder" shall mean a bidder who, among other qualities determined necessary for performance, is competent, experienced and financially able to perform the contract.

"Responsive Bidder" shall mean a bidder who submits a bid that complies with the terms and conditions of the invitation for bids, including plans, drawings, specifications and other provisions of the contract documents.

"Retainage" shall mean that money belonging to the Contractor which has been retained by the awarding authority conditioned upon final completion and acceptance of all work in connection with the Project.

"Singular/Plural" the singular shall include the plural and vice versa, unless the context clearly indicates otherwise.

"Trade Contracts" "Trade contracts" or "multiple prime contracts" are multiple but separate contracts with the City on the same Project that represent significant construction activities performed concurrently with and closely coordinated with construction activities performed on the Project under other trade contracts.

"Unbalanced Bid" Unbalanced bids may be considered non-responsive and may be subject to rejection. An unbalanced bid includes but is not limited to one which results in a substantial advance payment to the contractor.

3. Work to be Performed: The City contemplates the construction of a public works project as generally described in the Advertisement for Bid and as more particularly described, shown and depicted on the plans, specifications, drawings and in the contract documents.

4. Bidding, Generally:

- A. All bids must be made upon the bid proposal forms contained in the contract documents, shall state the amount bid for each item as shown therein and all blanks shall be properly filled in and bid proposal executed as required.
- B. Any bidder may withdraw his or its bid, either personally or by telegraphic or written request (not by facsimile), at any time prior to the scheduled opening time for receipt of bids. Except as provided in Ala. Code §39-2-11(b)(c)(d), no bid may be withdrawn after opening of bids prior to the time of returning bid bonds as provided for herein.
- C. Any unauthorized conditions, limitations or provisos attached to the bid proposal, except as otherwise provided herein, will render a bid proposal informal and may cause its rejection. Unbalanced bids

may be subject to rejection. Bids without the General Contractor's license number and a copy of the license will be rejected.

- D. All bids will be opened in public at the time and date specified in the Notice of Advertisement for bids, unless otherwise altered by addendum. All bidders are invited to be present at the opening of bids. No bids will be received after the time established for the opening of bids.
- E. All bids are to be enclosed in a sealed envelope addressed to the City of Tuscaloosa, P. O. Box 2089, Tuscaloosa, Alabama and/or hand delivered to the City Clerk, 2201 University Boulevard, City Hall, Tuscaloosa, Alabama. All bids are to be marked to indicate clearly the Project to which it applies and include the following language: "Bid Enclosed" and "Attention City Clerk."

NOTE: Bidders current General Contractor's license number must be displayed on the bid and the sealed envelope.

5. Responsible, responsive bidders: The City reserves the right to reject any bid that is submitted by a bidder that is determined by the City to not be a responsible bidder or whose bid proposal is not responsive.

In determining whether a bidder or bid is responsible and/or responsive, the City reserves the right to also request and consider the following factors:

- A. Types or kinds of materials or items best suited to the City's needs for the Project.
- B. A current financial statement of the bidder and/ or bonding capability or limits.
- C. An accurate inventory of equipment to be used on the Project for a list of key personnel to be used on the Project and detailed histories of their experience.
- D. A list of similar work performed by any person, firm, or corporation with the same name as the name or any of the names in the bidder's proposal within the last five (5) years.
- E. A list of five (5) references familiar with the bidder's competence, experience, capabilities, skill and integrity.
- F. A statement of bidder pertaining to bankruptcies, judgments, liens or litigation within the last five (5) years. Such statement shall also apply to each company, officer and the key personnel on the Project.
- G. The General Contractor's State license number and class.
- H. Bidder's performance and prosecution of past projects for the City.
- I. An unbalanced bid.
- J. Other information supplied in the bid proposal.

The City may make such investigations as he deems necessary to determine the ability of the Bidder to perform the work, and the Bidder shall furnish to the City all such information and data for this purpose as the City may request. The City reserves the right to reject any Proposal if the evidence submitted by, or investigation of, such Bidder fails to satisfy the City that such Bidder is properly qualified to carry out the obligations of the Contract and complete the work contemplated therein.

6. Bid Bonds: Each bidder must submit with its bid, a cashiers check drawn on an Alabama bank, made payable to the City of Tuscaloosa or a fully executed bid bond on the form that is contained in the contract documents, executed by a surety company duly authorized and qualified to make bond in the State of Alabama. All bonds and/or cashiers check will be made payable to the City of Tuscaloosa for an amount not less than five (5) percent of the City's or its engineers or architects estimated cost of the Project or of the total bid in the proposal, but in no event more than \$50,000.00. Provide, however, Federal Procurement Standards will prevail if a conflict arises between this section and Ala. Code § 41-16-50 through 41-16-63 and § 39-2-4, as amended, through the 1981 Regular Session as it relates to the "bid guarantee." The purpose of said bid bond is to insure that the successful bidder will enter into a written contract with the City for the Project on the form included in the contract documents and furnish a performance bond and payment bond executed by a surety company duly authorized and qualified to make such bond in the State of

Alabama, in the amount required and provide evidence of insurance as required by the bid documents within time specified or if no time is specified, within thirty (30) days after the forms have been presented to the successful bidder for signature. Provided; however, if extenuating circumstances prevail, the City may grant an extension of time not exceeding five (5) days for the return of the contract bonds and evidence of insurance.

The price or cost of all items bid shall remain in effect for a period of fifty (50) days after Notice of Award.

7. Return of Bid Bonds: All bid bonds, except those of the three lowest bona fide bidders, will be returned immediately after bids have been checked, tabulated and the relation of the bids established. The bid bonds of the three lowest bidders may be retained and if so will be returned as soon as the contract bonds and the contract documents of the successful bidder have been approved and properly executed.

In the event it is necessary to defer a contract award for longer than fifteen (15) days, after opening of bids, then all bid bonds, except that of the potential successful bidders will be returned.

Award of the contract will be made within the time specified after the opening of bids. In the event no award is made within such time, all bids may be rejected and all bonds returned.

Provided; however, the potentially successful bidder may enter into a written agreement with the City for an extension of time for consideration of its bid, in which case, the bidder's bond shall remain in full force and effect or the City may permit said bidder to substitute a satisfactory surety for the cashier's check if submitted as a guaranty to the bid bond.

8. Forfeiture of Bid Bonds: Should the successful bidder or bidders to whom a contract is awarded fail to execute a contract(s) and furnish acceptable contract securities and evidence of insurance, as required, within thirty (30) days after the prescribed forms have been presented to him/her, the City may retain from the proposal guaranty, if it is a cashier's check or recovered from the principal or the sureties, if the guaranty is a bid bond, the difference between the amount of the contract as awarded, and the amount of the proposals of the new lowest bidder. If no other bids are received, the full amount of the proposal guaranty may be so retained and recovered as liquidated damages for such default. Any sum so retained or recovered shall be the property of the awarding authority.

9. Consideration of Bid Proposals:

- A. Generally: The contract will be awarded to the lowest responsible and responsive bidder, unless the City determines that all the bids are unreasonable or that it is not in the best interest of the City to accept any of the bids. Award of the contract will be made on the basis of the lowest actual bid amount for the contract, which is defined as the total of the bid and/or extended total amounts for unit price items, plus requested and accepted additive or deductive alternates, pursuant to the provisions hereof. The City reserves the right to reject all bids and/or reject and rebid the Project should it determine the same is in the best interest of the City.
- B. Minor irregularities as determined by the City or its representatives, will not cause a bid to be non-responsive and may be waived by the City.
- C. Bidder must possess all licenses and permits required by applicable law, rule or regulation for the performance of the work prior to bidding.
- D. Where the City elects to prequalify contractors prior to bidding, it shall be understood that such prequalification may be general in nature and shall not limit the City's right to revoke such prequalification pursuant to Ala. Code §39-2-4(d) (1975).
- E. Joint ventures shall not generally be considered acceptable bids without special waiver from the City, which must be requested in writing at least thirty (30) days prior to bid opening.
- F. Additive and/or Deductive Alternates: If the City has elected to request bids for additive and/or deductive alternates, then the following procedure shall be the basis for calculating such bids:

- 1) Deductive Alternates: Any deductive alternate from the base bid shall constitute cumulative deductions from the base bid; and in determining the lowest bidder, if the City elects to consider any deductive alternates, the City will proceed to consider the bids upon the basis of the base bids of all qualified bidders minus the respective deduction stated for the first alternate. If the City determines that it wishes to proceed to consider additional deductive alternates, it may do so sequentially and in like manner throughout the deductive alternates the City elects, so that the base bids of all qualified bidders shall be calculated minus the respective number of deductive alternates in sequence the City has elected to consider. The lowest responsible responsive bid will be the lowest actual base bid of a qualified bidder less the selected sequential deductive alternates.
 - 2) Additive Alternates: To determine additive alternates, any additive alternate shall constitute cumulative additions to the base bid; and in determining the lowest bidder if the City elects to consider any additive alternates, the City will proceed to consider the bids upon the basis of the base bid of all bidders plus the respective addition stated for the first alternate. If the City determines that it wishes to proceed to consider additional additive alternates it may do so sequentially, and in like manner, throughout the additive alternates, the City elects, so that the base bids of all qualified bidders shall be calculated plus the respective number of additive alternates in sequence the City has elected to consider. The lowest responsible responsive bid will be the lowest actual base bid of a qualified bidder plus the selected sequential additive alternates. Once the City has determined the lowest responsible responsive bidder as set forth herein, then it may award the contract on the basis of accepting and/or rejecting any additive and/or deductive alternates of that bid as it determines is in the best interest of the City.
- G. **No Bids or Only One Bid**: In the event no bid proposals or only one bid proposal is received in response to the City's Advertisement for Bids at the time stated for the opening of bids, the City may elect at its discretion, any of the following options:
- 1) Advertise for and seek other competitive bids.
 - 2) Direct that the work shall be done by force account under its direction and control.
 - 3) Negotiate for the work through the receipt of informal bids. Provided; however, where only one responsible and responsive bid has been received, any negotiation for the work shall be for a price lower than that bid.
- H. An unbalanced bid.

10. Materials and Work: All materials, which the engineering plans specify or are required, will be installed as they are shown on the drawings, plans and/or specs.

- A. Brand names, catalog numbers, weights, etc., are used to indicate levels of quality only and are not intended to restrict the bidding. If bidding on an item of another brand or manufacturer than that specified, bidder's proposal should be accompanied by brochures or other pertinent literature giving detailed specifications of the item(s) on which the proposal is being made. Bids or proposals received without sufficient literature to determine equal quality may not be considered. Final determination as to equal quality will be made by the City.
- B. **Quantities**: The quantities shown in the proposal shall be considered by the contractor as the quantities required to complete the work for the purpose of bidding. Should the actual quantities required in the construction of the work be greater or less than the quantities shown, an amount equal to the difference of quantities at the unit prices bid for the items will be added to or deducted from the contract total.
- C. **Adjustment Items**: During the course of work, the prices bid for adjustment items may be used by the City to increase or decrease the total cost for the work if the quantity of work exceeds or is less than the amount shown on plans.

selected must be listed in the most current edition of Circular 570 of the U.S. Treasury Department, Companies Holding Certificates of Authority as Acceptable Sureties on Federal Bonds and as Acceptable Reinsuring Companies.

14. Power-of-Attorney: The attorney-in-fact (resident agent) who executes the performance bond and/or payment bond on behalf of the surety must attach a notarized copy of his or her power-of-attorney as evidence of his authority to bind the surety of the date of execution of the bonds. Certification by a resident agent authorized to do business in Alabama is required.

15. Insurance: The successful contractor shall file with the City, at the time of delivery of the signed contract, satisfactory evidence of insurance, the requirements as set forth in the contract agreement. Satisfactory evidence of insurance shall include at a minimum, the insurers standard "Certificate of Insurance" (modified pursuant to insurance requirements of the contract agreement) and the agents verification of insurance as required by Section 26. If the City deems that additional evidence or clarification, etc., of insurance is appropriate, the bidder shall promptly furnish the same to the City upon request.

16. Examination of Contract Documents and of the Site of the Project: Before submitting a bid proposal for the Project, each bidder shall carefully examine the Contract Documents, including but not limited to plans, drawings, specifications, contract, etc., visit the site, and satisfy itself as to the nature and location of the Project, and the general and local conditions, including weather, the general character of the site or building, the character and extent of existing work within or adjacent to the site, any other work being performed or proposed thereon at the time of submission of their bids. It shall obtain full knowledge as to transportation, disposal, handling, and storage of materials, availability of water, electric power, and all other facilities in the area which will have a bearing on the performance of the Project for which they submit their proposals. The submission of a proposal shall be prima facie evidence that the bidder has made such examination and visit and has judged for and satisfied himself as to conditions to be encountered regarding the character, difficulties, quality, and quantities of work to be performed and the material and equipment to be furnished, and as to the contract requirements and contingencies involved. It shall be the Bidder's obligation to verify for himself and to his complete satisfaction, all information concerning site and surface conditions.

17. Subsurface Reports: Prior to Bid opening, the City will make available to prospective Bidders, upon request, any information that it may have as to subsurface conditions and surface topography at the work site. Investigations of subsurface conditions were made for the purpose of study and design, and neither the City nor its consultants that performed such testing assume any responsibility whatsoever in respect to the sufficiency or accuracy of borings, or of the logs of test borings, or of other investigations that have been made, or of the interpretations made thereof, and there is no warranty or guarantee, either expressed or implied, that the conditions indicated by such investigations are representative of those existing throughout such area, or any part thereof, or that unforeseen developments may not occur.

Logs of test borings, geotechnical reports, or topographic maps showing a record of the data obtained by the investigations of surface and subsurface conditions that are made available shall not be considered a part of the Contract Documents, and are available only for the convenience of the Bidders. Such logs and reports represent only the opinion of the Engineer/Architect or Consultant as to the character of the materials encountered by him in his investigations of the test borings.

Information derived from inspection of logs of test borings, or pits, geotechnical reports, topographic maps, or from Drawings showing location of utilities and structures will not in any way relieve the Contractor from any risk, or from properly examining the site and making such additional investigations as he may elect, or from properly fulfilling all the terms of the Contract Documents.

The City shall not be responsible for any interpretations or conclusions drawn from any subsurface exploration reports or borings. Each bidder is to base his bid upon his determination of the subsurface conditions and of the types

and quantities or material to be encountered or needed. Additional tests or other exploratory operations may be made at no cost to the City.

18. Interpretation of Plans and Specifications: If any bidder contemplating submitting a bid for the proposed contract is in doubt as to the true meaning of any part of plans, specifications, or other proposed contract documents, he may submit to the Engineer/Architect or Construction Manager, as the case may be, a written request for an interpretation thereof at least ten (10) days prior to bid opening. The bidder submitting the request will be responsible for its prompt delivery. Any interpretation of the proposed documents will be made only by written addendum duly issued and a copy of such addendum will be mailed or delivered to each person receiving a set of such documents. The City, Construction Manager or Engineer/Architect will not be responsible for any other explanations or interpretations of the proposed documents.

19. General Contractor's Permit or License: The attention of all bidders is called to the provisions of the State law governing general contractors as set forth in Ala. Code §34-8-1 et seq. (1975), particularly in regard to the need for and evidence of a State general contractor's license. The provisions of said statute are adopted herein by reference and form a part of the Contract with the selected bidder should this Project be awarded.

Bidders are reminded that they will be governed by said statutes insofar as they are applicable. To summarize the above quoted statutes, Ala. Code §34-8-1, et seq. (1975) provides that no one is entitled to bid and no contract may be awarded to anyone who does not possess a valid general contractor's permit or license, including specialty classifications for the work, as provided by the foregoing sections of the State Code, and rules and regulations promulgated pursuant thereto and that said bid may not be considered without evidence being produced that he is so qualified. Trade contractors must be duly licensed in accordance with applicable law. The City may not enter into a contract with a nonresident corporation that is not qualified under the State law to do business in Alabama.

Bidder MUST include with proposal contractor's current license number and a copy of the license. State law, Ala. Code §34-8-8(b) (1975) requires all bids to be rejected which do not contain general contractor's license number.

20. U. S. Products Preference: The successful bidder (contractor) shall comply with Ala. Code §39-3-1 (1975), shall agree to utilize in the execution of the Project, materials, supplies and products manufactured, mined, processed or otherwise produced in the United States or its territories, if the same are available at reasonable and competitive prices and not contrary to any sole source specifications. It is further stipulated that a breach of the foregoing provision of this agreement by the contractor in failing to utilize domestic products shall result in a downward adjustment in the contract price equal to any realized savings or benefit to the Contractor.

21. Use of Domestic Steel: The attention of all bidders and that of the successful bidder (contractor) is drawn to Ala. Code §39-3-4 (1975), requiring the use of steel produced within the United States for municipal construction projects when specifications in the construction contract require the use of steel and do not limit its supply to a sole source. This provision is subject to waiver if the procurement of domestic steel products becomes impractical as a result of national emergency, national strike or other causes. Violations of the use of domestic steel requirements shall result in a downward adjustment in the contract price to equal any savings or benefit to the Contractor.

22. In State Bidder Preference: Pursuant to Ala. Code §39-3-5 (1975), in the letting of public contracts in which municipal funds are utilized, except those contracts funded in whole or in part with funds received from a federal agency, preference shall be given to resident contractors, and a nonresident bidder domiciled in a state having laws granting preference to local contractors shall be awarded Alabama public contracts only on the same basis as the nonresident bidders' state awards contracts to Alabama contractors bidding under similar circumstances; and resident contractors in Alabama, as defined in Ala. Code §39-2-12 (1975), be they corporate, individuals or partnerships, are to be granted preference over non-residents in awarding of contracts in the same manner and to the same extent as provided by the laws of the state of the domicile of the nonresident.

Nonresident bidders must accompany any written bid documents with a written opinion of an attorney-at-law licensed to practice law in such nonresident bidder's state of domicile, as to the preferences, if any or none, granted by the law of that state to its own business entities whose principal places of business are in that state in the letting of a public contract.

23. Applicable Laws: Each Bidder shall inform himself of, and the Bidder awarded a contract shall comply with, federal, state, and local laws, statutes, and ordinances relative to the execution of the work. This requirement includes, but is not limited to, applicable regulations concerning minimum wage rates, the use of domestic products, U.S. steel and resident labor, non-discrimination in the employment of labor, protection of public and employee safety and health, environmental protection, the protection of natural resources, fire protection, burning and non-burning requirements, permits, fees and similar subjects. Certain statutory requirements are summarized immediately hereinafter. The attention of all bidders is called to the fact that the work will be subject to compliance with all applicable City building and technical codes and will be subject, in addition to all other inspections, to inspection by a representative of the City of Tuscaloosa Building Inspections Department.

24. SRF/DWSRF Special Requirements. If all or any portion of the Project to which this contract applies is funded in whole or in part by the proceeds of a loan or loans from the Alabama Department of Environmental Management (ADEM) through either a State Revolving Fund for Wastewater or Water (SRF or DWSRF, respectively), additional requirements for the Contractor exist (Requirements). These Requirements relate to Project objectives for utilization of Minority Business Enterprises/Women Business Enterprises (MBE/WBE). The Contractor must document efforts made to utilize MBE/WBE firms and submit to ADEM, with a copy to the City within ten (10) days after contract execution, evidence of the positive steps in accordance with the requirements to utilize small minority and women businesses in the procurement of subcontracts.

Other Requirements relate to Federal Labor Standards, Title VI of the Civil Rights Act of 1964, Equal Employment Opportunity, Affirmative Action Equal Opportunity Clause, Goals and Timetables, compliance with Occupational Safety and Health Act of 1970 and Section 107 of Contract Work Hours and Safety Standards Act (PL91-54) which are adopted herein by reference to the extent applicable.

For DWSRF and SRF funded projects, special requirements are also set forth in Supplemental General Conditions. If not attached to the contract documents, Contractors should contact the City representative and/or the City's consulting engineer for a copy of all special requirements and conditions.

25. Special Conditions for Federally Funded Contracts. If all or any portion of the Project to which this contract applies is funded in whole or in part by the proceeds of a grant from an agency of the United States Government, additional requirements for the Contractor exist. A summary of these requirements entitled, "Special Conditions for Federally funded Contracts," is attached hereto and made a part hereof. Bidder should contact the Engineer or City Representative to confirm the applicability of these requirements to the Project.

26. Agent's Verification of Insurance. This form or a letter equivalent from the Insurance Agent should be submitted with each Contractor's Bid, or in the alternative, Contractor may provide a copy of the insurance policy or policies reflecting the coverages required herein.

27. Compliance with Immigration Law. By signing this contract, the contracting parties affirm, for the duration of the agreement, that they will not violate federal immigration law or knowingly employ, hire for employment or continue to employ an unauthorized alien within the State of Alabama. Furthermore, a contracting party found to be in violation of this provision shall be deemed in breach of the agreement and shall be responsible for all damages resulting therefrom, to the extent allowed by Federal law.

28. Compliance with Affordable Health Care Act. By signing this contract, the contracting parties affirm, for the duration of the agreement, that they will not violate federal compliance laws pertaining to the Affordable Health Care

Alternate No. 1 – Fencing: Select One: (ADD / DEDUCT)

The following lump sum of: N/A Dollars and _____ cents (\$ _____). (Amount written in words has precedence)

Alternate No. 2 – HVAC Controls: Select One: (ADD / DEDUCT)

The following lump sum of: N/A Dollars and _____ cents (\$ _____). (Amount written in words has precedence)

Alternate No. 3 – Paint at High Steel: Select One: (ADD / DEDUCT)

The following lump sum of: N/A Dollars and _____ cents (\$ _____). (Amount written in words has precedence)

Alternate No. 4 – Monument Sign: Select One: (ADD / DEDUCT)

The following lump sum of: N/A Dollars and _____ cents (\$ _____). (Amount written in words has precedence)

UNIT PRICES: Attach Bid Schedule for Landscaping and Sitework.

SALES AND USE TAX SAVINGS ACCOUNTING:

Pursuant to State of Alabama Act 2013-205, Section 1(g) the Contractor accounts for the sales tax NOT included in the bid proposal form as follows:

	<u>ESTIMATED SALES AND USE TAX</u>
BASE BID:	\$ <u>5,850.00</u>
Additive Alternate (if applicable):	\$ _____

Failure to provide an accounting of sales tax may render the bid non-responsive. Other than determining responsiveness, sales tax accounting shall not affect the bid pricing nor be considered in the determination of the lowest responsible and responsive bidder.

AS BUILT DRAWINGS: The Bidder's Proposal contains \$ 0.00 for "as built drawings."

BIDDER'S DECLARATION AND UNDERSTANDING: The undersigned, hereinafter called the Bidder, declares that the only persons or parties interested in this Proposal are those named herein, that this Proposal is, in all respects, fair and without fraud, that it is made without collusion with any official of the City, and that the Proposal is made without any connection or collusion with any person submitting another Proposal on this Contract.

The Bidder further agrees that he has checked and verified the completeness of the Contract Documents and that he has exercised his own judgment regarding the interpretation of subsurface information utilizing all pertinent data in arriving at his conclusions. The Bidder shall be fully responsible for any damages or liability arising out of his or his subcontractors pre-bid investigations.

The Bidder understands and agrees that if a Contract is awarded, the City may elect to award all schedules under one Contract, lump sum, separately, or in any combination that best serves the interests of the City.

The Bidder further declares that he has carefully examined the Contract documents for the construction of the Project and has checked and verified the completeness of the Contract Documents, that he has personally

inspected the site, that he has satisfied himself as to the quantities involved, including materials and equipment, and conditions of work involved. Bidder further declares that he is fully aware of the fact that the description of the work, quantities of work and materials, as included herein, is brief and is intended only to indicate the general nature of the work and to identify the said quantities with the detailed requirements of the Contract Documents. Bidder also declares that this Proposal is made according to the provisions and under the terms of the Contract Documents, which Documents are hereby made a part of this Proposal.

The Bidder declares that he understands and agrees that the quantities shown in the Advertisement for Bids and in the Proposal are approximate only and are subject to either increase or decrease; and that should quantities be decreased, he also understands and agrees that payment will be made on actual quantities installed at the unit bid prices, and will make no claim for anticipated profits for any decreases in the quantities. Actual quantities will be determined upon completion of the work.

START OF CONSTRUCTION AND CONTRACT COMPLETION TIME: The Bidder further agrees to begin work on the date stated in the Notice to Proceed and to fully complete the work, in all respects, within the time specified in the contract documents for completion.

EXPERIENCE OF BIDDER: Unless advised by the awarding authority in the Advertisement for Bids that the same is not required, the Bidder submits the following list of at least three clients for whom projects involving construction of similar projects have been performed within the past 5 years.

1.

<u>Salvation Army Center of Hope</u>	<u>800-728-7#25</u>
Name of Client	Telephone Number
<u>2902 Greensboro Avenue</u>	<u>Tuscaloosa</u>
Street	City
<u>Salvation Army Center of Hope</u>	<u>30,651</u>
Facility	Size
<u>Ward Scott Veron</u>	<u>205 345 6110</u>
Name of Engineer/Architect /Engineering Firm	Telephone Number

2.

<u>Tuscaloosa County Commision</u>	<u>205 248 4900</u>
Name of Client	Telephone Number
<u>Kauloosa Avenue</u>	<u>Tuscaloosa</u>
Street	City
<u>Environmental Services</u>	<u>60,000.00</u>
Facility	Size
<u>Elis Architects</u>	<u>205 752 4420</u>
Name of Engineer/Architect /Engineering Firm	Telephone Number

3.

<u>City of Northport</u>	<u>205 339 7000</u>
Name of Client	Telephone Number
<u>Union Chapel Road</u>	<u>Northport</u>
Street	City

Northport Fire Station #2	18,000	2016
Facility	Size	Date
Ward Scott Veron		205 345 6110
Name of Engineer/Architect/Engineering Firm		Telephone Number

PERFORMANCE OF WORK BY CONTRACTOR: The Bidder shall perform at least 50 percent of the work with his own forces (refer to the INSTRUCTIONS TO BIDDERS).

SUBCONTRACTORS: Unless the same information has been provided in the prequalification statement, the Bidder further certifies that if his bid is accepted, the following subcontracting firms or businesses will be awarded subcontracts for the following portions of the work:

Description of Work Insulation of piping

Crimson Insulation
Name

14116 Beck Lane Duncanville AL 35456
Street City State Zip

Description of Work _____

Name _____

Street City State Zip

Description of Work _____

Name _____

Street City State Zip

Description of Work _____

Name _____

Street City State Zip

SURETY: If the Bidder is awarded a construction contract on this Proposal, the Surety who provides the Performance Bond and Payment Bond will be:

Traveler's Casualty and Surety Company of America whose address is
One Tower Square, Hartford CT, 06183
Street City State Zip
Single Job Bond Limit 750,000.00 Aggregate Job Bond Limit 1,000,000.00

If Sole Proprietor or Partnership:

IN WITNESS hereto the undersigned has set his (its) hand this _____ day of _____, 20____.

Signature of Bidder

Title

If Corporation:

IN WITNESS WHEREOF the undersigned corporation has caused this instrument to be executed and its seal affixed by its duly authorized officers, this 30th day of March, 2017.

(seal) _____
Turner Plumbing, Inc.
Name of Corporation
By [Signature]
President
Title
Attest [Signature]
Secretary

The Bidder declares that he understands and agrees that the quantities shown in the Advertisement for Bids and in the Proposal are approximate only and are subject to either increase or decrease; and that should quantities be decreased, he also understands and agrees that payment will be made on actual quantities installed at the unit bid prices, and will make no claim for anticipated profits for any decreases in the quantities. Actual quantities will be determined upon completion of the work.

Attached hereto is a (Bid Bond) or (Check) for the sum of 5% NTE \$50,000.00 according to the conditions under "Instructions to Bidders" and provisions therein.

Dated this 30th day of March, 2017.

STATE OF ALABAMA)
TUSCALOOSA COUNTY)

CITY OF TUSCALOOSA PUBLIC WORKS CONTRACT DOCUMENTS

SECTION FOUR
BID BOND TO THE CITY OF TUSCALOOSA, ALABAMA
(2017)

KNOW ALL MEN BY THESE PRESENTS, that we, the undersigned, _____
Turner Plumbing, Inc. as Principal; and _____
Travelers Casualty and Surety Company of America as Surety, (NOTE: If cashier's check drawn on an
Alabama Bank utilized in lieu of corporate surety, attach check as required by bid documents) are hereby held and
firmly bound unto the City of Tuscaloosa, Alabama, a Municipal Corporation, as obligee, hereinafter called the City, in
the sum of Five Percent of the Bid Amount not to Exceed Fifty Thousand Dollars Dollars
(\$ 5% NTE \$50,000) for the payment of which sum, well and truly to be made, the said Principal and Surety
hereby jointly and severally bind ourselves, our heirs, executors, administrators, successors, and assigns.

The condition of the above obligation is such that whereas the Principal has submitted to the City a certain
Bid (Proposal), attached hereto and made a part hereof, to enter into a contract in writing with the City, for the
following Project or portion thereof:

Project: The EDGE Business Resource Center, Trade Contractor Bid Package 8 Plumbing

Location: Tuscaloosa, AL

Architect or Engineer: Ward Scott Architecture

Project Number: A16-1320

NOW, THEREFORE,

(a) If said Bid shall be rejected, or in the alternate,

(b) If said Bid shall be awarded and the Principal shall execute and deliver a contract in the Form of
Agreement as included in the Contract Documents for the Project, and shall execute and deliver Performance Bond
and Payment Bond in the Forms as attached to the Contract Documents executed by a surety company authorized
and qualified to make such bonds in the State of Alabama and in the amounts as required by the Instructions to
Bidders and submit the insurance certifications as required by the bid document and fulfill all other qualifications and
requirements of the Contract Documents and bid specifications (all properly completed in accordance with said Bid),
and shall in all other respects perform the agreement created by the acceptance of said Bid within thirty (30) days
after the prescribed forms have been presented to Bidder for execution;

Then, this obligation shall be void, otherwise, the same shall remain in full force and effect; it being
expressly understood and agreed that the liability of the Surety for any and all default of the Principal hereunder shall
be the amount of this obligation as herein stated.

The Surety, for value received, hereby stipulates and agrees that the obligations of said Surety and its bond shall in no way be impaired or affected by any extension of the time within which the City may accept such Bid; and said Surety does hereby waive notice of any such extension.

IN WITNESS WHEREOF, the above-bonded parties have executed this instrument under their several seals, this the 30th day of March, 2017 the name and corporate seal of each corporate party being hereto affixed and these presents duly signed by its undersigned representative, pursuant to authority of its governing body.

WITNESS:



PRINCIPAL:

Turner Plumbing, Inc. (SEAL)

By: 

Title: President

Address: P.O. Box 1276

Tuscaloosa, AL 35403

SURETY:

Travelers Casualty and Surety Company of America (SEAL)

One Tower Square

(Business Address)

Hartford, CT 06183

ATTEST:



By: 

Title: Charles F. Horton, Jr.
Attorney in Fact

NOTE: Surety must be qualified and duly authorized to make bonds in the state. All Bonds and Sureties are subject to review and approval by the City Attorney. Valid current Power of Attorney for Corporate Surety must be attached.

NOTE: Bidder may submit a cashier's check drawn on an Alabama bank to the order of the City of Tuscaloosa equal to 5% of the amount bid, in lieu of a Corporate Surety, under the same terms.

[END DOCUMENT—OFFICE OF THE CITY ATTORNEY]



POWER OF ATTORNEY

Farmington Casualty Company
Fidelity and Guaranty Insurance Company
Fidelity and Guaranty Insurance Underwriters, Inc.
St. Paul Fire and Marine Insurance Company
St. Paul Guardian Insurance Company

St. Paul Mercury Insurance Company
Travelers Casualty and Surety Company
Travelers Casualty and Surety Company of America
United States Fidelity and Guaranty Company

Attorney-In Fact No. 230377

Certificate No. 007022504

KNOW ALL MEN BY THESE PRESENTS: That Farmington Casualty Company, St. Paul Fire and Marine Insurance Company, St. Paul Guardian Insurance Company, St. Paul Mercury Insurance Company, Travelers Casualty and Surety Company, Travelers Casualty and Surety Company of America, and United States Fidelity and Guaranty Company are corporations duly organized under the laws of the State of Connecticut, that Fidelity and Guaranty Insurance Company is a corporation duly organized under the laws of the State of Iowa, and that Fidelity and Guaranty Insurance Underwriters, Inc. is a corporation duly organized under the laws of the State of Wisconsin (herein collectively called the "Companies"), and that the Companies do hereby make, constitute and appoint

Timothy L. Donahue, T. Gary Fitts, J. David Fitts, Charles F. Horton Jr., R. Forrest Fitts, Cheryl Camak, Julie Tubbs, and Chris Davidson

of the City of Tuscaloosa, State of Alabama, their true and lawful Attorney(s)-in-Fact, each in their separate capacity if more than one is named above, to sign, execute, seal and acknowledge any and all bonds, recognizances, conditional undertakings and other writings obligatory in the nature thereof on behalf of the Companies in their business of guaranteeing the fidelity of persons, guaranteeing the performance of contracts and executing or guaranteeing bonds and undertakings required or permitted in any actions or proceedings allowed by law.

The authority granted hereunder to sign, execute, seal and acknowledge any individual bond, recognizance, conditional undertaking, and other writing obligatory in the nature thereof is limited to the sum of TEN MILLION (\$10,000,000.00) DOLLARS per bond.

IN WITNESS WHEREOF, the Companies have caused this instrument to be signed and their corporate seals to be hereto affixed, this 24th day of October, 2016.

Farmington Casualty Company
Fidelity and Guaranty Insurance Company
Fidelity and Guaranty Insurance Underwriters, Inc.
St. Paul Fire and Marine Insurance Company
St. Paul Guardian Insurance Company

St. Paul Mercury Insurance Company
Travelers Casualty and Surety Company
Travelers Casualty and Surety Company of America
United States Fidelity and Guaranty Company



State of Connecticut
City of Hartford ss.

By: [Signature]
Robert L. Raney, Senior Vice President

On this the 24th day of October, 2016, before me personally appeared Robert L. Raney, who acknowledged himself to be the Senior Vice President of Farmington Casualty Company, Fidelity and Guaranty Insurance Company, Fidelity and Guaranty Insurance Underwriters, Inc., St. Paul Fire and Marine Insurance Company, St. Paul Guardian Insurance Company, St. Paul Mercury Insurance Company, Travelers Casualty and Surety Company, Travelers Casualty and Surety Company of America, and United States Fidelity and Guaranty Company, and that he, as such, being authorized so to do, executed the foregoing instrument for the purposes therein contained by signing on behalf of the corporations by himself as a duly authorized officer.

In Witness Whereof, I herunto set my hand and official seal. My Commission expires the 30th day of June, 2021.



[Signature]
Marie C. Tetreault, Notary Public

STATE OF ALABAMA



LICENSE NO. 22077
TYPE: RENEWAL

BID LIMIT: U
AMOUNT: UNLIMITED

State Licensing Board for General Contractors

THIS IS TO CERTIFY THAT

TURNER PLUMBING INC

TUSCALOOSA, AL 35407

is hereby licensed a General Contractor in the State of Alabama and is authorized to perform the following type(s) of work:
M-S: GAS PIPING, M-S: PLUMBING

until July 31, 2017

when this Certificate expires.

Witness our hands and seal of the Board, dated Montgomery, Ala.,

1st day of July, 2016

SECRETARY-TREASURER

Mark N. Conner

CHAIRMAN

Way W. King, Jr.

124951

E-Verify



Company ID Number: 479130

To be accepted as a participant in E-Verify, you should only sign the Employer's Section of the signature page. If you have any questions, contact E-Verify at 888-464-4218.

Employer Turner Plumbing Inc.	
Mary Fitts Name (Please Type or Print)	Title
Electronically Signed Signature	12/27/2011 Date
Department of Homeland Security – Verification Division	
USCIS Verification Division	
Name (Please Type or Print)	Title
Electronically Signed Signature	12/27/2011 Date

Information Required for the E-Verify Program

Information relating to your Company:

Company Name:	Turner Plumbing Inc.
Company Facility Address:	7532 Old Jug Factory Rd Duncanville, AL 35456
Company Alternate Address:	P.O. BOX 71531 TUSCALOOSA, AL 35407
County or Parish:	TUSCALOOSA
Employer Identification Number:	631215811

E-Verify



Company ID Number: 479130

North American Industry Classification Systems Code:	238
Administrator:	
Number of Employees:	20 to 99
Number of Sites Verified for:	1
Are you verifying for more than 1 site? If yes, please provide the number of sites verified for in each State:	
<ul style="list-style-type: none">• ALABAMA 1 site(s)	

Information relating to the Program Administrator(s) for your Company on policy questions or operational problems:

Name:	CONNIE F TURNER	Fax Number:	(205) 345 - 4886
Telephone Number:	(205) 345 - 4825		
E-mail Address:	connieturner@turnerplumbinginc.net		
Name:	Roberts F Karen	Fax Number:	(205) 345 - 4886
Telephone Number:	(205) 345 - 4825		
E-mail Address:	kroberts@turnerplumbinginc.net		
Name:	Mary B Fitts	Fax Number:	(205) 345 - 4886
Telephone Number:	(205) 345 - 4825		
E-mail Address:	maryfitts@turnerplumbinginc.net		

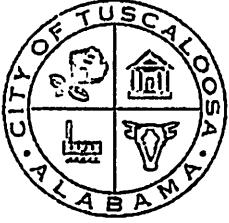

CITY OF TUSCALOOSA

BUSINESS LICENSE

EXPIRES DECEMBER 31, 2017

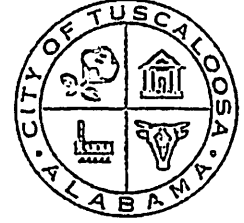

THIS LICENSE IS NOT TRANSFERABLE
OWNERSHIP CHANGE REQUIRES NEW LICENSE
LOCATION CHANGE REQUIRES APPROVAL

ACCOUNT ID: 000508
ISSUE NO: 263
ISSUE DATE: 01/09/2017

2017

NAICS: 238220
CATEGORY: CONTRACTOR
TYPE: PLUMBING (CERTIFIED)

LICENSED LOCATION:
1700 26TH AVENUE
TUSCALOOSA, AL 35401

TURNER PLUMBING INC
DBA: TURNER PLUMBING
P.O. BOX 1276
TUSCALOOSA, AL 35403

SUSAN F. SNOWDEN
DEPUTY CHIEF FINANCIAL OFFICER

WALTER MADDOX
MAYOR

****RENEW BEFORE FEBRUARY 15TH 2018 TO AVOID PENALTIES****



TURNPLU-01 TJACKSON

CERTIFICATE OF LIABILITY INSURANCE

DATE (MM/DD/YYYY)
3/20/2017

THIS CERTIFICATE IS ISSUED AS A MATTER OF INFORMATION ONLY AND CONFERS NO RIGHTS UPON THE CERTIFICATE HOLDER. THIS CERTIFICATE DOES NOT AFFIRMATIVELY OR NEGATIVELY AMEND, EXTEND OR ALTER THE COVERAGE AFFORDED BY THE POLICIES BELOW. THIS CERTIFICATE OF INSURANCE DOES NOT CONSTITUTE A CONTRACT BETWEEN THE ISSUING INSURER(S), AUTHORIZED REPRESENTATIVE OR PRODUCER, AND THE CERTIFICATE HOLDER.

IMPORTANT: If the certificate holder is an ADDITIONAL INSURED, the policy(ies) must be endorsed. If SUBROGATION IS WAIVED, subject to the terms and conditions of the policy, certain policies may require an endorsement. A statement on this certificate does not confer rights to the certificate holder in lieu of such endorsement(s).

PRODUCER Fitts Agency Inc. 1808 8th Street Tuscaloosa, AL 35401	CONTACT NAME: Tiffany Jackson, CISR PHONE (A/C, No, Ext): (205) 342-3556 E-MAIL ADDRESS: tjackson@fittsagency.com	FAX (A/C, No): (205) 342-3467
	INSURER(S) AFFORDING COVERAGE	
INSURED Turner Plumbing, Inc. P.O. Box 1276 Tuscaloosa, AL 35407	INSURER A: Frankenmuth Mutual	NAC # 13986
	INSURER B: Benchmark Ins Companies	NAC # 41394
	INSURER C:	
	INSURER D:	
	INSURER E:	

COVERAGES	CERTIFICATE NUMBER:	REVISION NUMBER:
------------------	----------------------------	-------------------------

THIS IS TO CERTIFY THAT THE POLICIES OF INSURANCE LISTED BELOW HAVE BEEN ISSUED TO THE INSURED NAMED ABOVE FOR THE POLICY PERIOD INDICATED. NOTWITHSTANDING ANY REQUIREMENT, TERM OR CONDITION OF ANY CONTRACT OR OTHER DOCUMENT WITH RESPECT TO WHICH THIS CERTIFICATE MAY BE ISSUED OR MAY PERTAIN, THE INSURANCE AFFORDED BY THE POLICIES DESCRIBED HEREIN IS SUBJECT TO ALL THE TERMS, EXCLUSIONS AND CONDITIONS OF SUCH POLICIES. LIMITS SHOWN MAY HAVE BEEN REDUCED BY PAID CLAIMS.

INSR LTR	TYPE OF INSURANCE	ADD'G SUBR INSD WVD	POLICY NUMBER	POLICY EFF (MM/DD/YYYY)	POLICY EXP (MM/DD/YYYY)	LIMITS
A	<input checked="" type="checkbox"/> COMMERCIAL GENERAL LIABILITY		BOP6123438	10/06/2016	10/06/2017	EACH OCCURRENCE \$ 1,000,000 DAMAGE TO RENTED PREMISES (Ea occurrence) \$ 500,000 MED EXP (Any one person) \$ 5,000 PERSONAL & ADV INJURY \$ 1,000,000 GENERAL AGGREGATE \$ 2,000,000 PRODUCTS - COMP/OP AGG \$ 2,000,000
	CLAIMS-MADE <input checked="" type="checkbox"/> OCCUR					
	GENL AGGREGATE LIMIT APPLIES PER					
	POLICY <input checked="" type="checkbox"/> PROJECT					
	LOC					
	OTHER					
A	<input checked="" type="checkbox"/> AUTOMOBILE LIABILITY		BA 6123438	10/06/2016	10/06/2017	COMBINED SINGLE LIMIT (Ea accident) \$ 1,000,000 BODILY INJURY (Per person) \$ BODILY INJURY (Per accident) \$ PROPERTY DAMAGE (Per accident) \$
	ANY AUTO					
	ALL OWNED AUTOS	SCHEDULED AUTOS				
	<input checked="" type="checkbox"/> HIRED AUTOS	<input checked="" type="checkbox"/> NON-OWNED AUTOS				
A	<input checked="" type="checkbox"/> UMBRELLA LIAB	<input checked="" type="checkbox"/> OCCUR	BOP6123438	10/06/2016	10/06/2017	EACH OCCURRENCE \$ 5,000,000 AGGREGATE \$ 5,000,000
	EXCESS LIAB	CLAIMS-MADE				
	DED <input checked="" type="checkbox"/> RETENTIONS	10,000				
B	WORKERS COMPENSATION AND EMPLOYERS' LIABILITY		WC044-0035704-2016A	10/06/2016	10/06/2017	<input checked="" type="checkbox"/> PER STATUTE <input checked="" type="checkbox"/> OTHER E L EACH ACCIDENT \$ 1,000,000 E L DISEASE - EA EMPLOYEE \$ 1,000,000 E L DISEASE - POLICY LIMIT \$ 1,000,000
	ANY PROPRIETOR/PARTNER/EXECUTIVE OFFICER/MEMBER EXCLUDED? (Mandatory in NH)	Y/N				
	If yes, describe under DESCRIPTION OF OPERATIONS below	N/A				
A	Installation Floater		BOP6123438	10/06/2016	10/06/2017	Limit 200,000
A	Leased/Rented Eqpmt		BOP6123438	10/06/2016	10/06/2017	Limit 50,000

DESCRIPTION OF OPERATIONS / LOCATIONS / VEHICLES (ACORD 101, Additional Remarks Schedule, may be attached if more space is required)
 Project: Central High School Renovations & Additions

CERTIFICATE HOLDER Tuscaloosa City Board of Education P.O. Box 038991 Tuscaloosa, AL 35403	CANCELLATION SHOULD ANY OF THE ABOVE DESCRIBED POLICIES BE CANCELLED BEFORE THE EXPIRATION DATE THEREOF, NOTICE WILL BE DELIVERED IN ACCORDANCE WITH THE POLICY PROVISIONS. AUTHORIZED REPRESENTATIVE
--	--

BID PROPOSAL ENCLOSED

PROPOSAL FROM: Turner Plumbing, Inc.

THE EDGE Business Resource Center

TO: City of Tuscaloosa
2201 University Blvd.
Tuscaloosa, AL 35401

Trade Package: EDGE-08 Plumbing

BID DATE: March 30, 2017

LICENSE NO.: General Contractor State of Alabama No.: 22077

BID LIMIT: U

STATE OF ALABAMA)
TUSCALOOSA COUNTY)
CITY OF TUSCALOOSA)

CITY OF TUSCALOOSA PUBLIC WORKS CONTRACT DOCUMENTS

SECTION FIVE
CONTRACT AGREEMENT
(2017)

THIS AGREEMENT made and entered into this 28th day of June, 2017, by and between TURNER PLUMBING, INC., hereinafter sometimes called the CONTRACTOR, as party of the first part, and the CITY OF TUSCALOOSA, Alabama, a Municipal Corporation, hereinafter sometimes called the CITY or OWNER, as party of the second part,

W-I-T-N-E-S-S-E-T-H:

In consideration of the amounts herein named and of the mutual agreements and provisions herein contained, the Contractor and the City agree in regard to a public works project (hereinafter either the "work" or the "Project") as described in the Advertisement for Bids.

The Contractor will perform the work and/or construct the Project as well as furnish at his own cost and expense all labor, tools, equipment and transportation as are herein and in the Contract documents required to be furnished by the Contractor, and shall perform all the work in a manner and form required to construct the Project described in and shown on the contract documents as the same are hereinafter more specifically described and as provided by the plans, specifications and documents which are attached hereto and made a part hereof, as if fully set out herein and addenda together with all plans and drawings on file in the office specified below.

ARTICLE I. GENERALLY

A. **Contract Documents:** As used throughout the documents constituting the contract, the term "Contract Documents" shall mean and include the following: Advertisement for Bids, Addenda (if issued), the Instructions to Bidders, the Bid Proposal, the General Specifications, the Detail Specifications, Supplemental and Special Conditions (if attached), together with this Contract Agreement and any modifications, including change orders, if made, and the drawings, plans and profiles that are now on file in the office referred to in the advertisement, the Performance Bond and the Labor and Material Bond, executed by the Contractor in connection with this Contract and insurance requirements and certificates.

All such documents hereinabove enumerated are adopted herein by reference and constitute the Contract between the parties to the same extent as if each were set out in full in this agreement.

B. **Independent Contractor:** The Contractor enters into this Contract with the City as an independent contractor and, as such, agrees that neither the City nor its officers, agents, employees or inspectors shall be responsible for the acts or omissions of the Contractor, or any subcontractor, or any of the Contractor's or subcontractor's agents or employees, or any other persons performing any of the work pursuant to this Contract. The Contractor shall be solely responsible for controlling construction manner, means and techniques consistent with the contract documents, plans and specifications.

C. **Order of Precedence:** Should there be a direct conflict between the various elements of the contract documents to the extent that the same cannot be reconciled to be read *in para materia*, then precedence shall be given the same in the following order:

1. Subsequent modifications (change orders or amendments) to contract agreement after execution
2. Addenda (if issued)
3. Supplemental general conditions and special conditions (if included)
4. The Contract Agreement
5. General and technical specifications
6. Large Scale Drawings (if included)
7. Enlarged Plans (if included)
8. Plans (if included)
9. Instructions to bidders
10. Advertisement for bids
11. Proposal (Bid)
12. Purchasing Agent Appointment Agreement (if utilized)

Where more than one document relates to the same matter if both can be given reasonable effect both are to be retained. Written specifications will take precedence over drawings.

D. Integration; Contract Terms and Construction:

1. **Integration:** This Agreement, together with all documents which constitute the "Contract Documents," constitute the entire agreement of the parties, as a complete and final integration thereof with respect to its subject matter. All understandings and agreements heretofore had between and among the parties are merged into this Agreement, which alone fully and completely expresses their understandings. No representation, warranty, or covenant made by any party which is not contained in this Agreement or expressly referred to herein has been relied on by any party in entering into this Agreement.
2. **Amendment in Writing:** This Agreement may not be amended, modified, altered, changed, terminated, or waived in any respect whatsoever, except by a further agreement or change order, in writing, properly executed by all of the parties.
3. **Binding Effect:** This Agreement shall bind the parties and their respective personal representatives, heirs, next of kin, legatees, distributees, successors, and assigns.
4. **Captions:** The captions of this Agreement are for convenience and reference only, are not a part of this Agreement, and in no way define, describe, extend, or limit the scope or intent of this Agreement.
5. **Construction:** This Agreement shall be construed in its entirety according to its plain meaning and shall not be construed against the party who provided or drafted it.
6. **Mandatory and Permissive:** "Shall," "will," and "agrees" are mandatory; "may" is permissive.
7. **Governing Laws:** The laws of the State of Alabama shall govern the validity of this Agreement, the construction of its terms, the interpretation of the rights, the duties of the parties, the enforcement of its terms, and all other matters relating to this Agreement.
8. **Ownership of Contract Documents:** The Contract Documents, and copies of parts thereof, are furnished and owned either by the City or the design professional. All portions of the Contract Documents, and copies of parts thereof, are the instruments of service for this Project. They are not to be used on other work and are to be returned to the City on request at the completion of the Project. Any reuse of these materials without specific written verification or adaptation by the City will be at the risk of the user and without liability or legal expense to the City or Engineer/Architect. Such user shall hold the City and Engineer/Architect harmless from any and all damages, including reasonable attorneys' fees, from any and all claims arising from any such reuse. Any such verification and adoption shall entitle the City to further compensation at rates to be agreed upon by the user and the City.

E. Rules of Construction: For the purposes of this contract, except as otherwise expressly provided or unless the context otherwise requires:

1. Words of masculine, feminine or neuter gender include the correlative words of other genders. Singular terms include the plural as well as the singular, and vice versa.
2. All references herein to designated "articles," "sections," and other subdivisions or to lettered exhibits are to the designated articles, sections and subdivisions hereof and the exhibits annexed hereto unless expressly otherwise designated in context. All article, section, other subdivision and exhibit captions herein are used for reference only and do not limit or describe the scope or intent of, or in any way affect this agreement.
3. The terms "include," "including," and similar terms shall be construed as if followed by the phrase, "without being limited to".
4. The terms "herein," "hereof," and "hereunder," and other words of similar import refer to this agreement as a whole and not to any particular article, section, other subdivision or exhibit.
5. All recitals set forth in, and all exhibits to, this agreement are hereby incorporated in this agreement by reference.
6. No inference in favor of or against any party shall be drawn from the fact that such party or such party's counsel has drafted any portion hereof.
7. All references in this agreement to a separate instrument are to such separate instrument as the same may be amended or supplemented from time to time pursuant to the applicable provisions thereof.

F. Construction Manager - Multiple Trade Contracts: If indicated in the Advertisement for Bids, the City has elected to engage the services of a Construction Manager for the work on this Project. If so, the same will be indicated in the bid packages and special supplemental conditions will be attached in regard to trade contracts. Contractor, as one of the multiple trade contractors on the Project shall adhere to all terms and conditions of the contract documents, particularly the supplemental conditions regarding multiple trade or multiple prime contractors. Any provision of the general conditions in direct conflict with the supplemental conditions is superseded to the extent of the conflict. If using a Construction Manager format, then this shall be a multiple trade or multiple prime contract agreement subject to the supervision and direction of a Construction Manager, in accordance with the terms and provisions of the Construction Manager's agreement with the City, which agreement is adopted herein by reference.

G. Coordination of Plans, Specifications, etc.: The specifications, the plans, drawings and all supplementary documents are essential parts of the Contract, and requirements occurring in one are as binding as though occurring in all. They are intended to be comprehensive to describe and provide a complete work. In case of discrepancy, figured dimensions shall govern.

H. Corrections of Plans, etc.: Should any portions of the plans, specifications or drawings be obscure or in dispute, they shall be referred to the Engineer/Architect and he shall decide as to the true meaning and intent. The Engineer/Architect shall also have the right to correct any errors or omissions at any time when such corrections are necessary for the proper fulfillment of said plans and specifications.

I. Taxes and Charges: Except to the extent the City and the Contractor are utilizing a "Purchasing Agent Appointment agreement," Contractor shall withhold and pay all sales and use taxes and all withholding taxes, whether local, state or federal and pay all Social Security taxes and also all State Unemployment Compensation taxes, and pay or cause to be withheld, as the case may be, any and all taxes, charges, or fees or sums whatsoever, which are now or may hereafter be required to be paid or withheld under any laws. Pursuant to Ala. Code §39-1-3 (1975), Contractor shall be reimbursed for any additional severance, sales or uses taxes incurred as a result of an increase in such taxes during performance of the contract.

J. **Shop Drawings and Submittals.** The Contractor shall submit shop drawings, samples and submittals depicting or representing the construction of portions of the Project in accordance with the plans and specifications to the Engineer/Architect and if there is no Engineer or Architect on the Project, to the City representative. The Contractor shall pay for or the cost may be withheld from payments to the Contractor for more than two (2) reviews of the shop drawings, samples or submittals or similar element of work by the Engineer, Architect or City representative.

K. **Alabama Immigration Law.** By signing this contract, the contracting parties affirm, for the duration of the agreement, that they will not violate federal immigration law or knowingly employ, hire for employment or continue to employ an unauthorized alien within the State of Alabama. Furthermore, a contracting party found to be in violation of this provision shall be deemed in breach of the agreement and shall be responsible for all damages resulting therefrom, to the extent allowed by Federal law.

L. **Compliance with Affordable Health Care Act.** By signing this contract, the contracting parties affirm, for the duration of the agreement, that they will not violate federal compliance laws pertaining to the Affordable Health Care Act. Furthermore, a contracting party found to be in violation of this provision shall be deemed in breach of the agreement and shall be responsible for all damages resulting therefrom, to the extent allowed by Federal law.

M. **Compliance with Act 2016-312.** By signing this contract, the contracting parties affirm, for the duration of the agreement, that they are not currently engaged in, and will not engage in, the boycott of a person or an entity based in or doing business with a jurisdiction with which this state can enjoy open trade.

ARTICLE II. PAYMENTS, CLAIMS AND CHARGES, ETC.

A. **Contract Price:** The City will pay and the Contractor will accept in full consideration for the performance of the work/Project, subject to additions and deductions (including but not limited to liquidated damages) as provided in the contract documents and herein, the sum of One Hundred Seventy-Eight Thousand, Five Hundred Dollars and Zero Cents (\$ 178,500.00) and/or in unit prices as shown in Bidder's schedule for the base bid amount of \$ N/A , being the amount of the Contractor's bid as awarded by the City.

B. **Estimated Quantities and Unit Prices:** If award was made in whole or in part based upon unit prices, the Contractor agrees that the prices given in the Proposal are unit prices. The estimated quantities as stated in the Advertisement for Bids and in the Proposal and as indicated on the plans or in other places are approximate only, are subject either to increase or decrease and are only for the purpose of comparing on uniform basis the bids offered for the Project under this contract. The Contractor further agrees that should the quantities of any of the items of the work be increased, he will do the additional work at the unit prices set out in the Proposal and should the quantities be decreased, payment will be made on actual quantities at the unit prices and he will make no claim for anticipated profits for any decrease in the quantities. Actual quantities will be determined upon completion of the Project.

C. **Overtime Work by Contractor:** If the Contractor for his convenience and at his own expense should desire to carry on his work at night or outside regular hours, he shall submit written notice to the Engineer/Architect and he shall allow ample time for satisfactory arrangements to be made for inspecting the work in progress. At no time shall the notice be given less than 24 hours before such overtime work is started. The Contractor must obtain, through the Engineer/Architect, the City's approval for work at night, on Saturdays, Sundays or legal holidays. The Contractor shall light the different parts of the Project as required to comply with all applicable federal and state regulations and with all applicable requirements of the City.

Overtime hours shall be considered any hours worked by the Contractor on Saturday, Sunday and legal holidays, which in the Engineer/Architect's opinion requires the Engineer/Architect's resident observers' presence to observe such overtime work. Overtime hours requiring the presence of City inspectors shall be considered any hours worked by the Contractor in excess of eight (8) hours during any working day and/or in excess of forty (40) hours from Monday through Friday and/or any time on Saturday, Sunday or legal holiday. In general, it should be expected that

the Engineer/Architect's resident observer(s) or City's inspectors will be present at all times that the Contractor is working.

If the Contractor elects to schedule and perform overtime work, the Contractor shall pay the City for the City's resident inspector's salary plus costs for each hour of overtime work. Overtime shall be rounded up to the nearest whole hour. This amount shall include the inspector's salary at overtime rate, labor additive, which includes insurance, social security, workmen's compensation, sick pay, paid holidays, vacation pay and his vehicle and equipment. Payment to the City shall be made by a deduction from the Contractor's monthly payment invoice for any overtime worked.

D. Payments on Account/Payments Withheld/Retainage: Upon presentation of a verified application for payment, which shall include a "Contractor's Affidavit of Payment of Debts and Claims," AIA Form G706 or equivalent, then usually by the fifteenth (15th) day of each calendar month or as soon thereafter as is practical, as the Project progresses, the City shall make partial payments to the Contractor of the billable work performed less payments already made and less deductions for any incomplete, unaccepted or defective work. In making partial payments to the Contractor, there shall be retained five (5%) percent of the estimated amount of work done and value of materials stored on the site or suitably stored and insured off-site. Provided; however, after fifty (50%) percent of the Project has been satisfactorily completed, no further retainage will be withheld.

Retainage shall be held until final completion and acceptance of all work covered by the Contract Documents unless escrow or deposit arrangements are agreed to by the City. When maintenance periods are included in the Contract Documents covering highways, bridges or similar structures, such period shall be considered a component part of the contract and retainage will be held until the expiration of such periods.

On completion and acceptance of each separate building, public work or other separately identifiable and complete division of the Project in regard to which a separate price has been stated in the Contract Documents or can be separately ascertained, payment may be made in full including retainage but less deductions. Provided; however, the City will not consider making such payment on any such item of work if it is an integral part of a complete project.

All materials and work covered by partial payments as provided for herein shall become the sole property of the City; provided, however, the Contractor shall not be relieved from the sole responsibility for the care and protection of materials and work upon which payments have been made and for the restoration of any damaged work.

The City may also withhold from time to time from payment to the Contractor such an amount or amounts as may be necessary to pay and fully satisfy all claims and demands for labor and services rendered in and about the Project, including any such amount or amounts due to be paid to or by any subcontractor or supplier, amounts for City's or Engineer/Architect's observers or inspectors for contractors' overtime as herein provided, or for engineering or design services associated with Contractor initiated change orders or submittals in excess of that permitted herein. The Contractor hereby authorizes the City as its agent, to apply such amounts so withheld to the payment of any amount so due to be paid and all other just and lawful claims other than claims for damages for tort. In case of disagreement with reference to any such claim or claims, the City may keep such amounts so withheld on account of such claim or claims until such disagreement is finally settled and determined.

In addition, the City may also withhold payment of the whole or any part of a verified or approved application for payment from the Contractor to such an extent as may be necessary to protect itself from loss on account of any of the following causes discovered subsequent to its verification or approvals:

1. Defective work.
2. Evidence indicating probable filing of claims by other parties against the Contractor.
3. Failure of the Contractor or subcontractor to promptly make payments to subcontractors or for materials, labor, food stuffs and supplies.

4. Damage to another contractor under separate contract with the City.
5. Assessment of liquidated damages.

When the above grounds are removed, applications for payment will then be verified and/or approved for amounts not previously verified and approved because of them.

The Contractor shall not attempt to withdraw at any time during the term of this contract or any extensions thereof, without the expressed written consent of the City, the whole or any part of the amounts so retained by the City from payments due the Contractor by the establishment of an escrow account or by depositing securities in lieu thereof, pursuant to Ala. Code §39-2-12(e) or (f), or any amendments thereto or any equivalent law, ordinance or regulation. It is expressly agreed between the parties hereto that should the City elect not to consent to the same, then the Contractor shall not elect to, attempt to or in any manner endeavor to withdraw such retained amounts.

E. Claims for Extra Cost: If the Contractor claims that any instructions by drawings or otherwise involve extra cost or any extension of time, he shall notify the City in writing within ten (10) days after the receipt of such instructions and in any event before proceeding to execute the Project. Thereafter, the procedure shall be the same as that for change orders. No such claim shall be valid unless made in accordance with the terms of this section. There shall be no damages for delay.

Except as otherwise herein provided, no charge for any extra work will be allowed unless the same has been duly authorized in writing by the City and the price stated in such order.

F. Differing Site Conditions: If, in the performance of the Contract, subsurface or latent conditions are found to be materially different from those indicated by the plans and specifications, or unknown conditions of an unusual nature are disclosed differing materially from conditions usually inherent in work of the character shown and specified, the Contractor shall immediately notify the Engineer/Architect in writing regarding such conditions but in no event later than forty-eight (48) hours after discovery of such conditions by the Contractor.

The written notice shall describe the conditions, and other pertinent information, in no event shall such notice be later than forty-eight (48) hours before such conditions are disturbed. Upon such notice, or upon such observation of conditions, the Engineer/Architect will promptly make such changes in the plans and/or Specifications as he finds necessary (if any are necessary) to conform to the different conditions, and any increase or decrease in the cost of the Project resulting from such changes may be adjusted as provided under Change Orders or Claims for Extra Cost as set forth in the Contract documents.

G. Change Orders: Change orders shall be allowed only under the following conditions: 1) Minor changes for a total monetary amount less than that required for competitive bidding; or 2) Changes for matters incidental to the original contract necessitated by unforeseeable circumstances arising in the course of work under the contract; or 3) Changes due to emergencies; or, 4) Changes provided for in the original bidding and original Contract Documents as alternates; 5) Changes of relatively minor items not contemplated when the plans and specifications were prepared and the Project was bid and which are in the public interest and generally do not exceed 10 percent of the Contract Price, subject to Alabama Bid Law exceptions.

The Contractor or successful bidder is expected to complete the Project as bid and specified within the financial parameters stated therein. However, if it shall be determined that a change order condition possibly exists in any given case during the performance of the contract, the Contractor shall promptly notify in writing the representative of the City and shall not implement such change until having notified the representative of the City. If the change is minor in the opinion of the representative of the City and does not involve, 1) an adjustment in the contract sum or construction bid price, or 2) result in extension of the contract time, or 3) a material change in the contract scope of services, then the City representative may authorize the change in writing to the Contractor. The Contractor shall not perform such change until receipt of such written change order.

In the event the change order requested by the Contractor involves, 1) an increase in the contract sum or construction bid price, 2) extend the contract time, or 3) materially change the Contractor's scope of work or services, then the Contractor shall request a change order in writing and present the same to the City representative. The representative of the City, shall determine whether this is a change order which can be allowed and, if so, what exception it would fall under. The representative of the City shall then document the same, attach the same to the Contractor's request for a change order and submit the same with his recommendation to the City Council at its next or any subsequent regularly scheduled Council meeting for approval.

The City reserves the right to institute change orders as the Owner pursuant to the aforesaid terms and conditions.

In no event is a change order to be executed by the Contractor prior to approval thereof by the City, except for emergencies.

H. Determination of Adjustment of the Contract Sum: The adjustment of the Contract Sum resulting from a change in the Work shall be determined by one of the following methods as determined by Owner:

1. By mutual agreement to a lump sum based on or negotiated from an itemized cost proposal from the Contractor.
2. Additions to the Contract Sum shall include the Contractor's direct costs plus a maximum 15% markup for overhead and profit. Where subcontract work is involved, the total mark-up for the Contractor and a subcontractor shall not exceed 25%. No allowance for overhead and profit shall be figured on a change which involves a net credit to the Owner. For the purposes of this method of determining an adjustment of the Contract Sum, "overhead" shall cover the Contractor's indirect costs of the change, such as the cost of bonds, superintendent and other job office personnel, watchman, job office, job office supplies and expenses, temporary facilities and utilities, and home office expenses.

I. Construction Schedule and Periodical Estimates: Immediately after execution and delivery of the contract and before the first partial payment is made, the Contractor shall deliver to the City and Engineer/Architect and Construction Manager, a construction schedule in a form satisfactory to the City or Construction Manager, which may include CPM for all major trades, showing the proposed dates of commencement and completion of each of the various activities, of work required under the Contract documents, the interrelationship of each activity, sequences, resources for each and the anticipated amount of each monthly payment that will become due the Contractor in accordance with the progress schedule. The Contractor shall also furnish (1) a detailed estimate giving a complete breakdown on the contract price and (2) periodical itemized estimates of the work done for the purpose of making partial payments, however the same will not be considered as fixing a basis for additions to or deductions from the contract price. Scheduling is particularly critical if Contractor is a trade contractor and adherence to the Construction Manager progress schedule is required.

NOTE: Depending upon the complexity of the work the City may require CPM or equivalent meeting all criteria above.

J. Sales and Use Tax Savings: Pursuant to the invitation for bids, sales and use taxes are not to be included in the bid. The project will be administered in compliance with the State of Alabama Act 2013-205, Certificate of Exemption from Sales and Use Tax for Governmental Entities, regarding sales and use taxes. The Contractor shall be responsible for obtaining a certificate of exemption from the Alabama Department of Revenue for purchases of materials and other tangible property made part of the project. Any subcontractors purchasing materials or other tangible personal property as part of the project shall also be responsible for obtaining a certificate of exemption. The estimate sales and use tax saving must be accounted for on the bid proposal. Failure to provide the estimated sales

and use tax savings may render the bid as non-responsive. Other than determining responsiveness of the bid, sales and use tax accounting shall not affect the bid pricing nor shall be considered in the determination of the lowest responsible and responsive bidder

ARTICLE III. TIME

A. **Time for Completion/Delays:** The Contractor hereby agrees to commence work under this contract on the date to be specified in a written "Notice to Proceed" of the Engineer/Architect or thirty (30) days from the date of contract execution if no notice is issued, and to fully complete the Project within 435 consecutive calendar days thereafter. If this is a trade contract, then the Contractor shall perform within the time periods and at the times as established by the Construction Manager's approved construction schedule for the project. The Contractor further agrees to pay to the City, liquidated damages for each consecutive calendar day thereafter as hereinafter provided. Time is of the essence and a material element to this agreement.

NOTE: When maintenance periods are included in the contract for highways, bridges or similar structures, such periods shall be considered component parts of the contract. To the extent the construction schedule contains "float," the parties agree that the same belongs to the Project and may be utilized by either party.

Delay: If the Contractor is delayed at any time in the progress of work by any of the following causes, the Contractor may be entitled to a reasonable extension of time as determined by the City in which to complete the Project. Provided, however, no such delay nor the extension of time if granted shall be grounds for a claim by the Contractor for damages or for additional cost, expenses, overhead or profit or other compensation:

1. Fires, abnormal floods, tornadoes or other cataclysmic phenomenon of nature.
2. Strikes, embargoes, lockouts, war, acts of public enemy.
3. Change orders.
4. Acts of performance or delays in performance by other contractors employed by the City or their subcontractors.
5. Causes beyond the control of the Contractor.

Provided further, that the Contractor shall immediately give notice in writing to the City and follow extension of time procedures as provided for herein. The City expressly disclaims any liability to Contractor for any cost, expense or damage caused by other contractors, subcontractors or suppliers, including those engaged by the City. The City shall not be liable for damages or cost to the Contractor sustained due to any interference from utilities or appurtenances or from the operations of relocating the same.

B. **Extensions of Time:** All written requests for extensions of time must be submitted to Engineer/Architect within ten (10) days after the occurrence of the cause for delay. The Engineer/Architect shall ascertain the facts and the extent of the delay and shall recommend to the City Council whether it should extend the time for completing the Project. Any extension of time shall be in writing and processed as a change order.

For change orders requesting extensions of time due to rain, wind, flood or other natural phenomenon, the Contractor's written request must be accompanied, at the City's request, by a detailed report of weather at this site for the last ten (10) years with averages showing means and statistical deviations from mean averages to support request for extension.

No extension shall be made for delays due to rain, wind, flood or other natural phenomenon of normal intensity for the locality.

In the event any material changes, alterations, or additions are made as herein specified, which in the opinion of the Engineer/Architect will require additional time for execution of any work under the contract, then in that case, the

time of the completion of the Project may be extended through change order. No extensions of time shall be given for any minor changes, alterations or additions. The Contractor shall not be entitled to any reparation or compensation on account of such additional time or extensions of time. To the extent that the construction schedule contains "float," the parties agree that the same belongs to the Project and may be utilized by either party.

C. Right of the City to Terminate Contract: If the Contractor should be adjudged as bankrupt, or if it should make a general assignment for the benefit of its creditors, or if a receiver should be appointed for the Contractor or any of its property, or if it should persistently or repeatedly refuse or fail to supply enough properly skilled workmen or if it should refuse or fail to make prompt payment to persons supplying labor for the Project under the Contract, or persistently disregard instructions of the Engineer/Architect or fail to observe or perform any provisions of the Contract documents, or fail or neglect to promptly prosecute or perform the Project in accordance with the contract documents or otherwise be guilty of a substantial violation of any provision of the Contract documents, then the City may, on giving at least thirty (30) days' written notice to the Contractor, without prejudice to any other rights or remedies of the City in the premises, terminate the Contractor's right to proceed with the Project. In such event, the City may take over the Project and prosecute the same to completion, by contract or otherwise, and the Contractor and its sureties shall be liable to the City for any and all excess cost occasioned to the City thereby, including attorney's fees; and in any such case, the City may take possession of and utilize in completing the Project such appliances and plant of the Contractor or its subcontractors as may be on the site work and necessary or useful thereof. In the event of termination, the same shall not relieve the Contractor nor any of its sureties of their obligation pursuant to this agreement. In the event it becomes necessary for the City to maintain any legal action against the contractor, to enforce its rights herein, the Contractor shall pay the City all expenses associated therewith including a reasonable attorney's fee.

Owner may at any time and for any reason terminate Contractor's services and work at Owner's convenience. Upon receipt of such notice, Contractor shall, unless the notice directs otherwise, immediately discontinue the work and placing of orders for materials, facilities and supplies in connection with the performance of this Agreement. Upon such termination, Contractor shall be entitled to payment only as follows: (1) the actual cost of the work completed in conformity with this Agreement; plus, (2) such other costs actually incurred by Contractor as are permitted by the prime contract and approved by Owner; (3) plus ten percent (10%) of the cost of the work referred to in subparagraph (1) above for overhead and profit.

D. Liquidated Damages: Should the work under this contract not be completed within the time specified, scheduled or as extended, it is understood and agreed that there may be deducted by the City or Engineer/Architect from the partial and/or final payments to the Contractor or otherwise charged to the Contractor, a sum computed at the rate of Five Hundred Dollars (\$500.00) per day beginning from the stated or extended date of completion and continuing for so long as the Project remains incomplete. It is understood and agreed that the above deduction is not a penalty, but money due to reimburse the City/Owner for inconvenience and damage to the general public, due to the delay in the completion of the Project and is reasonable. The collection of liquidated damages by the City shall not constitute an election or waiver by the City of recovery of additional delay or non-delay related damages from the Contractor, and the City expressly reserves the right to recover actual damages for other harms resulting from delay. The provisions of the liquidated damage clause shall apply and continue to apply even if the Contractor terminates or abandons the Project prior to the scheduled completion dates.

The amounts of such liquidated damages and actual damages incurred by reason of failure to complete the work stipulated in the Contract are hereby agreed upon as reasonable estimates of the costs which may be accrued by the City. It is expressly understood and agreed that these amounts are not to be considered in the nature of penalties, but as damages which have accrued against the Contractor. The City shall have the right to deduct such damages from any amount due, or that may become due the Contractor, or the amount of such damages shall be due and collectible from the Contractor or Surety.

ARTICLE IV. WORK AND MATERIALS

A. **Cooperation of Contractor:** The Contractor shall have available on the job site, at all times, at least one (1) copy of the plans and specifications if prepared for the Project.

He shall give the Project the constant attention necessary to facilitate the progress thereof and shall cooperate with the City, Engineer/Architect and with other Contractors in every way possible. The Contractor shall at all times have a superintendent, capable of acting as his agent on the Project, who shall receive communications from the Engineer/Architect or his authorized representatives or the City's authorized representative. The superintendent shall have full authority to give and execute orders relating to the Project without delay and to promptly supply such tools, plant equipment, materials and labor as may be required.

The City reserves the right to utilize its own forces on the site or those of another contractor and to communicate through its representative directly with the Contractor.

B. **Coordination - Trade Contractors:** If the supplemental conditions are attached to these general conditions indicating that this Project involves the use of multiple trade or multiple prime contractors under the supervision and direction of a Construction Manager employed by the City, then each such trade contractor shall cooperate and coordinate its construction activities and operations with those of other trade contractors and other entities involved in the Project and included under different sections of the specifications that are dependent upon each other in any manner for proper and correct installation, connection and operation, to assure efficient, prompt, orderly and proper installation of each part of the Project.

When utilizing trade contractors and/or multiple prime contractors under the supervision of Construction Manager cooperation and coordination of activities is extremely important. Refer to the provisions of the supplemental conditions for detailed requirements.

C. **Superintendence:** The Contractor shall assign to and keep at the Project site competent supervisory personnel. The Contractor shall designate, in writing, before starting work, an authorized representative who shall be an employee of the Contractor and shall have complete authority to represent, to receive notice for, and to act for the Contractor. The Contractor shall not permit or allow any work to be conducted upon the Project site without the presence of supervisory personnel. The Engineer/Architect shall be notified in writing prior to any change in superintendent assignment. Using his best skill and attention, the Contractor shall give efficient supervision to the Project. The Contractor shall be solely responsible for all construction means, methods, techniques, and procedures, for providing adequate safety precautions, and for coordinating all portions of the Project under the Contract. It is specifically understood and agreed that neither the Engineer/Architect nor the City shall not have control or charge of and shall not be responsible for the construction means, methods, techniques, or procedures, or for providing adequate safety precautions in connection with the Project under the Contract.

D. **Contractor's Tools and Equipment:** The Contractor's tools and equipment used on the Project shall be furnished in sufficient quantity and of a capacity and type that will adequately and safely perform the work specified, and shall be maintained and used in a manner that will not create a hazard to persons or property, or cause a delay in the progress of the Project.

E. **Furnishing Labor and Equipment:** The Contractor shall furnish and pay for all equipment, labor and supervision, and all such materials as required to be furnished in the Notice to Bidders and as may other-wise be necessary to the completion of the Project and the operation of each construction crew required.

F. **Employees:** The Contractor shall employ only competent, skillful workers on the Project, and whenever any person shall appear to be incompetent or to act in a disorderly, unsafe improper manner, such person shall promptly be removed from the Project by the Contractor.

G. **Materials and Appliances:** Unless otherwise stipulated, the Contractor shall provide and pay for all other materials, water, heating, lighting, fuel, power, transportation, machinery, appliances, telephone, sanitary facilities, temporary facilities and other facilities and incidentals necessary for the execution and completion of the Project.

The Contractor warrants to the City and the Engineer/Architect that, unless otherwise specified, all materials and equipment furnished under this contract shall be new, and both workmanship and materials shall be of good quality, free of faults and defects, and in conformance with the Contract Documents. The Contractor shall, if required, furnish satisfactory evidence as to the kind and quality of materials. In selecting and/or approving equipment for installation in the Project, neither the City nor Engineer/Architect assume responsibility for injury or claims resulting from failure of the equipment to comply with applicable federal, state, and local safety codes or requirements, or the safety requirements of a recognized agency, or failure due to faulty design concepts, or defective workmanship and materials. Material and/or equipment damaged by flooding or other causes during the construction period shall be subject to rejection by the Engineer/Architect; reconditioning and/or repairing material and/or equipment is not acceptable.

H. **Asbestos and Hazardous Materials:** Unless specifically authorized and instructed to the contrary by the City, the Contractor shall not permit, allow, place, install or incorporate into the Project or upon the work site, any hazardous material(s), including, but not limited to, any products or materials that contain asbestos in any quantity. It shall be the responsibility of the Contractor to inspect all materials and products delivered for incorporation or installation in the Project to ensure that they contain no hazardous materials or asbestos. Where the Contractor or any subcontractor has or should have a reasonable suspicion that any product or material contains asbestos or other hazardous material, the Contractor shall immediately inspect the material or product, obtain a product or material data sheet, and notify the City's representative prior to installation or incorporation of the same into the Project. Any product or material determined to contain asbestos or other hazardous material shall be removed from the Project immediately and properly disposed of as required by law. Products or material to which the contractor should pay particular attention to avoid the presence of asbestos incorporated therein include, but are not limited to the following: concrete, batt insulation, roof insulation, building felts, mastics, water proofing products, adhesives, resilient flooring products, ceiling tiles, interior coatings, exterior coatings, roofing, pipe installation, duct installation and pre-assembled items of equipment.

At the completion of the Project, the Contractor shall submit a duly executed Asbestos Affidavit in the form as attached hereto prior to final payment.

The Contractor is responsible for insuring that all of its employees and subcontractors are adequately trained to handle hazardous materials in accordance with 49 CFR §172(g).

I. **Protection of Work and Property:** The Contractor shall furnish and install all necessary temporary works for the protection of the Project. The Contractor shall at all times adequately maintain, guard and protect his own work from damage, and safely guard and protect private, commercial, industrial, the City's and others' property from injury or loss arising in connection with this Contract. He shall make good any such damage, injury or loss, except such as may be directly due to errors in the plans or specifications or caused by agents or employees of the City.

The Contractor shall protect all existing vegetation such as trees, shrubs, and grass on or adjacent to the site which are not required to be removed or do not unreasonably interfere with construction, as may be determined by the Engineer/Architect, and be responsible for all cutting or damaging of trees and shrubs or grassed areas, including damage due to careless operation of equipment, stockpiling of materials or equipment.

Care shall be taken by the Contractor in felling trees that are to be removed to avoid any unnecessary damage to vegetation or other trees that are to remain in place. Any limbs or branches unavoidably broken during such operations shall be trimmed with a clean cut and painted with an approved tree priming compound. The Contractor

may be required to replace or restore at his own expense all vegetation not protected and preserved, as above required, that may be destroyed or damaged.

The Contractor shall provide and maintain all passageways, guard fences, lights, and other facilities required for protection by federal, state or municipal laws and regulations or local conditions.

The Contractor shall comply with local and state regulations governing the operation of premises which are occupied and shall perform the contract in such a manner as not to interrupt or interfere with the operation of other facilities.

The Contractor shall store his apparatus, materials, supplies, and equipment in such orderly fashion at the site of the Project as will not unduly interfere with the progress of his work or the work of any other contractor.

Necessary crossings of curbs, sidewalks, roadways or parkways shall be protected against damage and any damage shall be repaired by or at the expense of the Contractor.

The Contractor shall not place upon the Project or any part thereof, loads inconsistent with the design or safety of that portion of the Project.

The Contractor shall provide and maintain access to all public and private properties at all times and be responsible for any damage caused by his operation to existing driveways, yards, streets, parking lots, utilities, railroads, etc., and such damage shall be corrected at the Contractor's expense. Roadways authorized closed by State or Local authorities shall be maintained to provide access to all fire, police, and other emergency vehicles and all individuals having private property in the closed area. The Contractor shall notify at least 24 hours in advance the Fire, Police, and Transportation Departments having local jurisdiction, the Owner and any other individuals, businesses, or agencies that may be affected.

J. Protection of Existing Utilities. Contractor shall be responsible for any damage to existing structures or the interruption of any utility services which shall be repaired or restored promptly by and at the expense of the Contractor.

To that extent, the Contractor shall provide whatever measures are necessary to properly protect and maintain all existing utilities encountered in the course of the work. The Contractor shall be exclusively responsible to the utility owner for any and all damages to the various utilities caused by the Contractor's actions or lack of actions to adequately protect the same.

The Contractor shall determine the exact location of all existing utilities before commencing work and agrees hereby to be fully responsible and liable for any and all damages which might occur by his failure to exactly locate and/or preserve the location of any and all underground or overhead utilities. The Contractor shall be solely and directly responsible to the utility owner for any and all damages to the various utilities, caused by the Contractor's actions or lack of actions to adequately protect such utilities. If any utilities are to be affected during the course of construction, the Contractor shall so notify the owners thereof at least seventy-two (72) hours prior to any such construction activity. The Contractor shall fully cooperate and coordinate with all utility owners in the event of an interruption to any utility service. The cost for locating, uncovering and protecting underground and/or overhead utilities is included within the Contractor's bid price for various other items of work.

The Contractor shall maintain all storm sewers, drains and/or ditches so that flow is not disturbed or impeded. The Contractor shall protect storm drains, inlets and/or ditches, lawns, landscaping and other facilities, from damage during the testing, and flushing.

K. **Limiting Exposures:** The Contractor shall prosecute the work on the Project to insure that no part of the construction, complete or in progress, is subject to harmful, dangerous, damaging, or otherwise deleterious exposure during the construction period. Where applicable, such exposures include, but are not limited to the following:

Excessive static or dynamic loading	Rodent and insect infestation
Excessive internal or external pressures	Combustion
Excessively high or low temperatures	Electrical Current
Thermal shock	High speed operation
Excessively high or low humidity	Improper lubrication
Air contamination or pollution	Unusual wear or other misuse
Water or ice	Contact between incompatible materials
Solvents	Destructive Testing
Chemicals	Misalignment
Light	Excessive weathering
Puncture	Unprotected storage
Abrasions	Improper shipping or handling
Heavy traffic	Theft
Soiling, staining and corrosion	Vandalism
Bacteria	

The Contractor shall minimize dust and air pollution through the use of water or other devices, require the use of properly operating combustion emission control devices and by encouraging the shutdown of construction vehicles when not in use.

L. **Safety:** The completed Project shall include all necessary permanent safety devices, such as machinery guards and similar ordinary safety items as may be appropriate or required by law. Further, any feature of the Project (including City-furnished or City-selected equipment) subject to such safety regulations shall be fabricated, furnished, and installed in compliance with these requirements. Contractors and manufacturers of equipment shall be held responsible for compliance with the requirements included herein. Contractors shall notify all equipment suppliers and subcontractors of the provisions of this Article.

In selecting and/or accepting equipment for installation in the Project, neither the City nor Engineer/Architect assume responsibility for any personal injury, property damage, or any other damages or claims resulting from failure of the equipment to comply with applicable safety codes or requirements, or the safety requirements of a recognized agency, or failure due to manufacturer's faulty design concepts, or defective workmanship and materials. The Contractor shall indemnify and hold the City, Program Coordinator, and Engineer/Architect harmless against any and all liability, claims, suits, damages, costs, or expenses without limitation arising out of the installation or use of such equipment.

The Contractor shall take all necessary precautions for the safety of employees on the Project and shall comply with all applicable provisions of federal, state, and municipal safety laws and building codes to prevent accidents or injury to persons on or about or adjacent to the premises where the Project is being performed. He shall erect and properly maintain at all times, as required by conditions, and progress of the Project, all necessary safeguards for the protection of workmen and the public, and shall post danger signs warning against the hazards created by features of construction and the site.

Machinery, equipment and all hazards shall be guarded or eliminated in accordance with the State Accident Prevention in Construction provisions to the extent that such provisions are not in contravention with applicable laws.

The Contractor shall do whatever work is necessary for safety and be solely and completely responsible for conditions of the jobsite, including safety of all persons (including but by no means limited to the public, site personnel,

visitors, or employees) and property during the Contract period. The contract period shall include any subsequent warranty or other period associated with Project deficiency or repair and all hours including, and in addition to, normal working hours.

Safety provisions shall conform to the Federal and State Departments of Labor and the Occupational Safety and Health Act (OSHA), and all other applicable federal, state, county, and local laws, ordinances, codes, the requirements set forth herein, and any regulations that may be specified in other parts of these Contract Documents. Where any of these are in conflict, the more stringent requirement shall be followed. The Contractor's failure to thoroughly familiarize himself with the aforementioned safety provisions shall not relieve him from compliance with the obligations and penalties set forth therein.

The Contractor shall at all times provide proper facilities for safe access to the work by authorized government officials (federal, state, county and local) and representatives of the Owner.

M. Traffic Control: The Contractor shall be responsible for traffic control, including plan and devices to the extent the same is required due to work in, upon or in proximity to public right-of-way, streets, roads or vehicular traffic. The traffic control plan and all traffic control devices shall conform at a minimum to the Manual on Uniform Traffic Control Devices for Streets and Highways, Latest Edition, Federal Highway Administration. A copy of which is on file in the office of the City of Tuscaloosa Director of the Department of Transportation for examination. Copies may be obtained from the Alabama Department of Transportation. Should the appropriate public authority determine a greater degree of traffic control is required, then the Contractor shall promptly provide same. The Contractor shall submit a plan to the City Engineer for approval before commencing construction.

Reasonable means of ingress and egress by vehicular and/or pedestrian traffic to property adjacent to the Project shall be maintained at all times. The Contractor shall indemnify and hold the City harmless for any claims or causes of action including but not limited to those for inverse condemnation and/or lost profits arising out of or in any manner associated with access to or the restriction or prevention thereof to adjoining property. Traffic control and erosion control is of paramount importance during the construction of this Project and the terms and conditions in the contract documents in regard to these matters must be strictly adhered to.

N. Responsibility to Act in Emergency: In case of an emergency which threatens loss or damage to property, and/or safety, the Contractor shall act, without previous instructions from the City or Engineer/Architect, as the situation may warrant. The Contractor shall notify the Engineer/Architect thereof immediately thereafter. Any claim for compensation by the Contractor, together with substantiating documents in regard to expense, shall be submitted to the City through the Engineer/Architect. The claim will be handled in accordance with the provisions for extra work. However, if the emergency is created or aggravated by the Contractor, he shall be liable for the resulting damages. If the Contractor fails to take necessary action as required by such an emergency, the City may assign another Contractor or use his own forces to perform the emergency work. Costs or damages arising from the failure of the Contractor to act in an emergency may be deducted from the Contractor's request for payment.

O. Sanitary Regulations: The Contractor shall provide and maintain such sanitary accommodations for the use of his employees and those of his subcontractors as may be necessary to comply with the requirements and regulations of the local and State Department of Health. At a minimum, necessary sanitary conveniences for the use of the laborers on the work shall be erected and maintained by the Contractor, in such a manner and at such points as shall be approved by the Engineer/Architect. Their use shall be strictly enforced. In the Construction Manager format, the City may provide sanitary accommodations through the Construction Manager.

P. Cutting, Patching, etc.: Unless otherwise stated in the contract documents, the Contractor shall do all necessary cutting, fitting and patching of the Project that may be required to properly receive the work, to make its several parts join together properly, receive and provide for the work of various trades, and be received by the work of other contractors, or as required by drawings and specifications to complete the Project. After such cutting, he shall

replace or restore or repair and make good all defective or patched work as required by the Engineer/Architect. He shall not cut, excavate or otherwise alter any work in any manner or by a method or methods that will endanger the Project, adjacent property, workmen, the public or the work of any other contractor. The Contractor shall check the location of all sleeves, openings, slots, etc., for the piping, ducts, breeching, conduits, louvers, grills, fans, etc., as they are laid out on the job.

Provisions for openings, holes and clearances through walls, beams, floors, ceilings and partitions shall be made and checked by the Contractor and/or his subcontractor in advance of constructing such parts of the Project and unnecessary, superfluous or dangerous cutting shall be avoided.

Pipes passing through concrete or masonry walls shall be protected by pipe sleeves two sizes larger than the pipe, plus its installation to provide free movement.

Under no condition shall structural, framing or other parts or members subjected to computed stress be cut or disturbed without the approval of the Engineer/Architect. Any plates, studs or joists, and/or rafters that are approved to be cut to execute necessary work shall be securely strapped and braced to restore their strength by approved methods.

Unless otherwise indicated in Supplemental Conditions, all road crossings and/or driveways cut by the Contractor during the performance of the Project shall be returned to service as soon as possible and replaced or repaired within seven (7) calendar days.

All major thoroughfares must be repaired the same day as cut. The Contractor shall be responsible for the safety and welfare of the traveling public while construction work is being done and until the City accepts the Project.

The Contractor will replace at his own expense, all pipe and accessories that may be broken, damaged, stolen or lost and all materials that may become damaged, lost, stolen or misused.

The Engineer/Architect's approval shall be obtained before cutting or drilling holes in concrete or masonry that tend to damage or weaken the load capacity.

Q. Trailers: With the approval of the City or Engineer/Architect, the Contractor may park trailers or other structures for housing men, tools, machinery and supplies, but they will be permitted only at approved places and their surroundings shall be maintained at all times in a sanitary and satisfactory manner by the Contractor. On or before the completion of the Project, all such trailers or structures shall be removed, unless the City authorizes their abandonment without removal, together with all rubbish and trash, at the expense of the Contractor.

R. Construction Staking: If necessary, the Engineer or the City will furnish initial lines and grades to establish the initial horizontal and vertical control points and define the beginning and ending points of the Project. The Contractor is responsible for engaging the services of a qualified Engineer or land surveyor to replace and/or re-establish in accordance with the construction plans and/or specs, all construction stakes that are disturbed, displaced or destroyed during construction.

If the Contractor finds any errors or discrepancies with the construction staking or the criteria upon which it is based, he/she shall promptly notify the Owner's representative.

S. Periodic Cleanup: The Contractor shall periodically, at least weekly, or as requested during the progress of the Project, clean up and remove from the premises, all refuse, rubbish, scrap materials and debris caused by its employees or its subcontractors resulting from its work, to the end that all times the premises are sanitary, safe, reasonably clean, orderly and workmanlike. Trash and combustible materials shall not be allowed to accumulate inside buildings or elsewhere on the premises. At no time shall any rubbish be thrown from window openings, except during

renovations with adequate precautions and into proper receptacles. The Contractor shall comply with all municipal litter and construction site ordinances.

Before the Project is considered as complete, all rubbish created by or in connection with the construction must be removed by the Contractor and the premises left in a condition by the Contractor satisfactory to the City. Street, curbs, crosswalks, pavements, sidewalks, fences and other public and private property disturbed shall be restored to their former condition or better, and final payment will be withheld until such work is finished by the Contractor.

Contractor shall conduct cleaning and disposal operations to comply with local ordinances and anti-pollution laws. No burning or burying of rubbish or waste materials is permitted on the Project site. The Contractor shall dispose of any hazardous material in a safe manner, off site, in accordance with applicable laws and regulations and shall not dispose of volatile or hazardous waste in storm or sanitary sewer drainage ditches, streams or waterways.

Contractor shall periodically wet down dry materials and rubbish to lay dust and prevent blowing dust; and shall provide adequate and approved containers for collection and disposal of waste material, debris and rubbish, removing grease, dust, dirt, stains, labels, fingerprints and other foreign materials from exposed and semi-exposed surfaces.

T. Termite Control. If the Project involves construction of a building or if otherwise specifically required by the City, then the Contractor shall provide soil treatment for termite control under all interior slabs on grade and foundation walls, and as herein specified. Contractor shall also comply with manufacturer's instructions and recommendations for work, including preparation of substrate and application and shall engage a professional pest control operator, licensed in accordance with regulations of governing authorities for application of soil treatment solution and doing business in the state where the Project is located for a minimum of five (5) years.

Contractor shall not apply soil treatment solution until excavating, filling and grading operations are completed, except as otherwise required in construction operations. To insure penetration, the soil treatment will not be applied to frozen or excessively wet soils or during inclement weather. Contractor shall comply with all handling and application instructions of the soil toxicant manufacturer. The type of materials to be used for soil poisoning shall first be submitted to the City for approval.

The soil treatment solution shall be an emulsible concentrate insecticide for dilution with water, specially formulated to prevent infestation by termites. Fuel oil will not be permitted as a dilutant.

Contractor shall strictly comply with the Environmental Protection Agency's (EPA) rules and regulations governing chemicals and their use. Only soil treatment solutions which are not injurious to planting shall be used. Other solutions may be used as recommended by Applicator when acceptable to the EPA, local governing authorities, and the Engineer/Architect.

Contractor shall comply with the following requirements when applying the soil treatment solution:

1. **Surface Preparation:** Remove foreign matter which could decrease effectiveness of treatment on areas to be treated. Loosen, rake, and level soil to be treated, except previously compacted areas under slabs and foundations. Toxicants may be applied before placement of compacted fill under slabs if recommended by toxicant manufacturer.
2. Under slab-on-grade structures, treat soil before concrete slabs are placed using either power sprayer or tank type garden sprayer.
 - (A) Apply 4-gallons of chemical solution per 10 linear feet to soil in critical areas under slab, including entire inside perimeter inside of foundation walls, along both sides at interior

partition walls, around plumbing pipes and electric conduit penetrating slab, and around interior column footings.

- (B) Apply one gallon of chemical solution per 10 sq. ft. as an overall treatment under slab and attached slab areas where fill is soil or unwashed gravel. Apply 1-1/2 gallons of chemical solution to areas where fill is washed gravel or other coarse absorbent material.
 - (C) Apply 4 gallons of chemical solution per 10 linear feet of trench for each foot of depth from grade to footing, along outside edge of building. Dig a trench 6" to 8" wide along outside of foundation to a depth of not less than 12". Punch holes to top of footing at not more than 12" o.c. and apply chemical solution. Mix chemical solution with the soil as it is being replaced in trench.
3. Post signs in areas of application warning workers that soil poisoning has been applied. Remove signs when areas are covered by other construction.
 4. Reapply soil treatment solution to areas disturbed by subsequent excavation or other construction activities following application.

U. Erosion Control.

1. To the extent there has been issued by the City Engineer a land development permit in accordance with applicable ordinances, the Contractor shall conform to and abide by all terms and conditions of such permit.
2. Erosion control measures shall be performed on all disturbed areas in accordance with the BMPP included in the Notice of Intent and with Section 665, Alabama Highway Department Specifications. The CONTRACTOR will perform all erosion control measures necessary to prevent silt and soil from leaving construction area and entering private property or the "Waters of the State." Erosion control measures shall be in strict accordance with Alabama Non Point Source Management Program Document and EPA Storm Water Pollution Prevention for Construction Activities.
3. In accordance with Section 665 of Alabama Highway Department Specifications, temporary erosion control work shall involve the construction of temporary berms, dikes, drains, fences, dams, etc. with the use of temporary seeding, mulching, erosion control netting, hay bales, sandbags, check dams, etc., as necessary in order to prevent silt and soil from leaving rights-of-way and entering private property or from washing into drainage structures located on State or County rights-of-way. CONTRACTOR shall mow grassed areas as required during the construction phase of the contract.
4. Erosion control measures shall be maintained by the CONTRACTOR through the warranty period of the contract. If additional measures are required to correct problems which might occur, these shall be performed by the CONTRACTOR at no additional cost to the OWNER.
5. Materials used for erosion control measures shall be in accordance with Section 665.02 of Alabama Highway Department Specifications and shall include hay bales, sandbags, silt fencing rip rap, crushed stone, mulch or other materials necessary in order to accomplish erosion control.

V. Wastewater Containment and Management Plan. In accordance with ADEM Consent Order, NPDES permit NO. AL0022713, Tuscaloosa WWTP, Tuscaloosa County (125) dated September 8, 2009 and the "City of Tuscaloosa, Water and Sewer Department Engineering Report and Compliance Plan", December 2009; to the extent that construction activity by the Contractor involves any wastewater infrastructure or construction activities in close proximity to any wastewater infrastructure and/or to any City sanitary sewer assets the Contractor shall submit to the City Engineer, prior to commencing construction, a wastewater containment and management plan (the "Plan"). The Plan shall adequately address the means, methods and techniques to be employed by the Contractor for containing and transporting wastewater in a sanitary manner without, at any time, permitting the discharge of wastewater into the environment or creating the necessity of a State required sanitary sewer overflow report. The Plan shall be submitted by the Contractor to the Office of City Engineer for review and approval before commencing any construction activity. The City Engineer may waive the requirement of submitting a Plan if he/ she determines that the construction activity

to which the Plan would relate does not involve any potential for the discharge of wastewater into the environment or creating the potential for the necessity of a State required sanitary sewer overflow report.

W. Environmental Clause/Covenant. Contractor shall not allow any toxic, hazardous or contaminated substances or gases (including, but not limited to, asbestos and raw materials which include hazardous constituents or any other similar substances or materials which are included under or regulated by any local, state, or federal law, rule or regulation pertaining to environmental regulations, contamination, clean-up or disclosure such as, without limitation, the Comprehensive Environmental Response Compensation and Liability Act of 1980 ("CERCLA"); the Clean Air Act (42 U.S.C. Sec. 7401 et seq.); the Clean Water Act (33 U.S.C. §1251 et seq.); the Resource Conservation and Recovery Act (42 U.S.C. §6901 et seq.); and the Toxic Substances Control Act (42 U.S.C. §2601 et seq.) or state environmental clean-up or disclosure acts and statutes as all such acts and statutes exist now or are hereafter amended (such acts and statutes referred to herein as "Environmental Laws")(such substances or gases referred to herein as 'Hazardous Substances') to be stored, located, or discharged on the premises without specific prior written consent of the City. Contractor shall comply with all Environmental Laws affecting the premises. Contractor covenants to hold the City, its officers, agents and employees harmless from and against any loss, costs, damage or expenses (including attorney's fees and expenses) arising out of the presence of Hazardous Substances (as hereinbefore described) on or about the premises or the violation of any Environmental Laws with respect thereto, the occurrence of which Hazardous Substances on the premises or the violation of any Environmental Laws shall have arisen solely from the acts or omissions of Contractor, its subcontractors, agents, invitees and employees. This indemnity shall survive the termination of this contract and shall inure to the benefit of the City of Tuscaloosa, its successors and assigns.

ARTICLE V. INSURANCE, LIABILITY, ETC.

A. Contractor's Insurance (Generally):

1. Insurance Required. The Contractor shall not commence work under this contract until it has obtained all insurance required by the Contract documents and such insurance has been accepted by the City. The Contractor shall maintain the required insurance during the term of the contract including any extensions of the term.

Insurance shall be written in comprehensive form by insurance companies rated A- or better by A. M. BEST and shall protect the Contractor and the City against claims for injuries to members of the public (including City employees) or damages to property of others (including City property) arising out of any act of the Contractor or any of its agents, employees or subcontractors and shall cover both on-site and off-site operations under this contract and insurance coverage shall extend to any motor vehicles or other related equipment, irrespective of whether the same is owned, non-owned or hired.

The obtaining and maintaining by Contractor and subcontractors of the insurance required herein does not relieve the Contractor of any responsibilities, obligations or duties to the City pursuant to this contract.

2. Additional Insurance. The Contractor shall have an insurance professional review the Contractor's activities in regard to the performance of this contract and the Contractor shall obtain any further or additional insurance or greater limits as recommended by the insurance professional.

3. Insurance Limits. Neither the setting of insurance limits or requirements nor the acceptance or approval of the same by the City imply or represent that the limits or the insurance carrier is sufficient or that such insurance actually has been obtained, that being the responsibility of the Contractor.

4. Subcontractors. The Contractor shall require all subcontractors to take out and maintain the type of insurance required herein to the extent of their involvement in the Project so as to be adequate to protect against liability. In the event any work under this Contract is performed by a subcontractor(s), the Contractor shall remain responsible for any liability directly or indirectly arising out of the work performed under this Contract, regardless of

whether or not such work is covered by the subcontractor's insurance. The Contractor shall not allow any subcontractor to commence work on the project until all similar insurance required of the subcontractor has been obtained. All subcontractors shall maintain required insurance during the term of the contract including any extensions of the term.

5. City's Right to Review Coverage. The City shall have the right to inspect and approve Contractor's insurance coverage herein required. Should the City deem it advisable to modify the coverage in any way, it shall so request of the Contractor in writing and should the Contractor fail to modify the coverage, then the City may pay the cost of any increased coverage or take credit for any decreases as may be appropriate. Review or acceptance of insurance by the City or representatives of the City shall not relieve or decrease the responsibility of the Contractor hereunder.

6. Waiver of Subrogation. To the extent that the Contractor is required to maintain insurance coverage for loss or damage to property or bodily injury, including Builders Risk All Risk insurance, the insurance must waive and the Contractor hereby waives subrogation of claims against the City, its officers, agents and employees.

7. City as Additional Insured. The City shall be named as additional insured , for ongoing and completed operations for up to two (2) years, on the Contractor's and any subcontractor's policies for any claims arising out of work performed under this Contract. The Contractor shall provide the City with a Certificate of Insurance naming the City as an additional insured using ISO for CG 2010 1185 (or a substitute form providing equivalent coverage) or on the combination of ISO forms CG 20 10 07 04 or CG 20 33 07 04 and CG 20 37 07 04 (or a substitute or ISO form providing equivalent coverage) naming the City as an additional insured , giving all parties a 30 notice of cancellation or intent not to renew the insurance, a waiver of subrogation and list any and all exclusions. The coverage available to the City as an additional insured shall not be less than \$1,000,000 Each Occurrence, \$2,000,000 General Aggregate (subject to a per project general aggregate applicable to the project,), \$2,000,000 Products/completed Operations Aggregate, and \$1,000,000 Personal and Advertising injury limits. Additional insured coverage shall apply as primary, non contributory, insurance with any other insurance afforded to the City and the Contractor.

8. Elevators, Hoist and Cranes. If the Contractor or a subcontractor will utilize in connection with the performance of the work pursuant to this contract an elevator, material hoist, crane or other equipment, or conveyor, then the Contractor shall take out and maintain or require the subcontractor to take out and maintain insurance that shall protect the Contractor and the City against claims for injuries to members of the public (including City employees) or damages to property of others (including City property) arising out of any act of the Contractor or any of its agents, employees or subcontractors resulting from the operation of such elevator, material hoist, crane or other equipment, or conveyor.

B. Insurance:

1. Workmen's Compensation Insurance: The Contractor shall take out and maintain during the term or any extensions of this contract Workmen's Compensation Insurance as required by Alabama law for all of its employees employed at the site of the Project or off-sites related to the Project and, in case any work is sublet, the Contractor shall require the subcontractor similarly to provide Workmen's Compensation Insurance for all of the latter's employees unless such employees are covered by the protection afforded by the Contractor.

In case any class of employees engaged in any work under this contract at the site of the Project is not protected under the Workmen's Compensation statute, the Contractor shall provide, and shall cause each subcontractor to provide, adequate accident insurance for the protection of its employees not otherwise protected.

Water or Navigational Exposure; Where work under this contract may trigger the requirement for Federal Longshoreman's and Harbor worker's Act and Federal Jones Act or insurance required by other applicable law or regulations, the Contractor shall obtain the same if required.

2. Comprehensive Automobile and Vehicle Liability Insurance: The Contractor shall maintain during the term or any extensions of this contract, comprehensive automobile and vehicle liability insurance. The limits of liability shall not be less than \$1,000,000 combined single limit or equivalent.

3. Commercial General Liability Insurance: The Contractor shall maintain during the term or any extensions of this contract, Commercial General Liability Insurance, including officers, agents and employees. The limits of liability shall not be less than \$1,000,000 Each Occurrence, \$2,000,000 General Aggregate (subject to a per project general aggregate applicable to the project), \$2,000,000 Products/Completed Operations Aggregate, and \$1,000,000 Personal and Advertising Injury Limits Combined Single Limit or equivalent.

4. Owner's Protective Insurance: For projects with a contract amount of \$500,000.00 or greater, an Owner's Protective Policy is required in the minimum amount of \$1,000,000 each occurrence. Provided; however, the City may require such insurance on projects of lesser amount if an insurance limit amount is stated herein.

5. Umbrella Excess Liability Over Primary Insurance: The Contractor shall take out and maintain during the term of this contract, and any extensions thereof, Umbrella Excess Liability Insurance. The minimum limits of coverage shall be as follows:

Each Occurrence	\$ <u>5,000,000.00</u>
Aggregate	\$ <u>5,000,000.00</u>

The coverage shall be over the required general liability insurance and automobile liability insurance as a minimum. There shall be no gaps or sublimit deductibles, etc.

6. Miscellaneous Insurance: The Contractor shall provide whatever insurance may be required of the City or the Contractor by permits or agreements, etc., with the railroad, highways, or other utilities. The Contractor shall familiarize himself with all insurance requirements contained in easements, permits, and agreements associated with this Project. The Contractor shall provide any Railroad Protective Liability and other General Liability Insurance in the amounts contained in the agreements, permits or easements or in greater amounts if higher limits are appropriate or required elsewhere. The Contractor shall bear the cost of all required insurance and shall include in his bid a sufficient amount to cover the cost of all required insurance. To the extent the City obtains permits or licenses for railroad or highway bores, crossings or other work involved in the Project, the Contractor shall obtain adequate insurance to protect itself and the City.

7. Builders Risk All Risk Insurance: To the extent applicable to the Project, the Contractor shall secure and maintain during the life of this Contract, Builder Risk All Risk Insurance coverage for 100 percent of the Contract Price. This insurance shall not exclude coverage for earthquake, landslide, tomado, flood, collapse or loss due to the result of faulty workmanship. Such insurance shall also provide for any damages caused by injury to, or destruction of, tangible property, including loss of use resulting therefrom, and shall pay all losses to the Contractor and the City as their interest may appear.

If this is a trade contract under a construction manager format, the provisions of this subsection shall not apply.

8. Proof of Carriage of Insurance: The Contractor shall furnish the City with satisfactory proof of carriage of the insurance required herein, in the form of an insurance certificate or if the City elects in the form of a policy. Insurance shall be in a form satisfactory to the City.

- (A) The Contractor's and any subcontractor's general liability and automobile liability insurance shall endorse the Owner (City of Tuscaloosa), its officers, agents and employees, as additional insured's for any claims arising out of work performed under this contract.
- (B) The Contractor's insurance endorsing the Owner and others as additional insured's shall be "primary" and non contributory as to such endorsed insured's.
- (C) Cancellation: The certificate and policy, as the case may be, shall state that the City shall be given thirty (30) days' written notice of cancellation or any change in the insurance coverage.
- (D) There shall be a statement that the Contractor and any subcontractors waive subrogation as to the City, its officers, agents, employees and Program Coordinator.
- (E) There shall be a statement that full aggregate limits apply per job or contract.
- (F) Agents verification of Contractor's insurance on form provided by the City or equivalent.
- (G) Insurance shall contain no exclusions for x, c or u.
- (H) Full aggregate limits must apply per job or contract.

C. No Personal Liability of Public Officials: In carrying out any of the provisions hereof in exercising any authority granted by the Contract, there will be no personal liability upon any public official.

D. Indemnity: To the maximum extent permitted by law, the Contractor shall save harmless, indemnify and defend the City, its officers, agents and employees from and against any and all claims and losses, cost, expense or liability including attorney's fees and litigation costs caused by, arising out of, resulting from, or occurring in connection with the performance of the work by the Contractor or any subcontractor, regardless of the fault, breach of contract, or negligence of the City, its officers, agents or employees excepting only such claims or losses that have been adjudicated to have been caused solely by the negligence of the City and regardless of whether or not the Contractor is or can be named a party in a litigation.

Contractor agrees to indemnify and/or reimburse the City for any fines, violations, charges, suits, or sums of money imposed by the Alabama Department of Environmental Management (ADEM), Environmental Protection Agency (EPA), or any administrative agency on the City of Tuscaloosa for any sewage or contaminate discharged or Wetlands regulations violation as a result of or arising out of the work by the Contractor pursuant to this agreement.

E. Errors and Omissions. The Contractor does agree to release and hold harmless the City of Tuscaloosa or any of its officers, agents and employees and its Program Coordinator from any damages claimed by the Contractor or subcontractors resulting from or attributable in whole or in part to, errors in or omissions of the plans and specifications, including final drawings of the Engineer/Architect or other design professionals. As to plans, specifications or designs prepared by independent design professionals, the parties agree that any City review or approval thereof was only for overall suitability, maintenance and usability and there are no express or implied warranties by the City as to the adequacy, accuracy, correctness, or code compliance thereof.

F. Exclusion of Contractor Claims: In performing its obligations, the Engineer/Architect and its consultants may cause expense for the Contractor or its subcontractors and equipment or material suppliers. However, those parties and their sureties shall maintain no direct action against the City or its officers, employees, agents and program coordinator for any claim arising out of, in connection with, or resulting from the Engineering services performed or required to be performed where such services are performed in good faith to protect the City or the Public.

G. Inadequate Surety/Insurance. It is further mutually agreed between the parties hereto that if, at any time after the execution of this agreement, any of the surety bonds of the Contractor or subcontractors relating to the Project for its faithful performance shall be deemed by the City to be unsatisfactory, or if for any reason such bond(s) ceases to be adequate to cover the performance of the work or the surety ceases to do business by agent in Tuscaloosa County, Alabama, the Contractor shall, at its expense, within five (5) days after the receipt of notice from the City so to do, furnish an additional bond or bonds in such form and amount and with such surety or sureties as shall be satisfactory

to the City. In such event, no further payment to the Contractor shall be deemed to be due under this agreement until such new or additional security for the faithful performance of the work shall be furnished in manner and form satisfactory to the City.

H. **Changes.** When changes in the scope of work by written order or change orders aggregate in amount equal to 10 percent of the total contract, including the change order or change orders, the insurance coverage included under this heading shall be increased accordingly by the Contractor. Proof of coverage shall be established by endorsement to the original policy or by re-issue of the original policy to include the added coverage, or in accordance with any other acceptable policy with the insuring company for increasing the coverage.

ARTICLE VI. OBSERVATION OF THE PROJECT

A. **Generally:** The Contractor shall furnish the Engineer/Architect and/or the City's observer with every reasonable facility for ascertaining whether or not the work performed is in accordance with the requirements and intent of the Specifications and Contract Documents. No work shall be done without suitable inspection by the Engineer/Architect's Inspector or the City's observer. Payment for work or failure to reject any defective work shall not in any way prevent later rejection when such defect is discovered, nor obligate the City to final acceptance. All work done when not in accordance with the Plans, specifications and contract will be rejected and, without cost to the City, shall immediately be removed and other work done in accordance therewith by the Contractor. If the Contractor fails to remove the work as above ordered, then the Engineer/Architect shall have the right and authority to stop the Contractor and his work at once and the City may correct the work as herein provided at the cost and expense of the Contractor.

Inspection is not acceptance and shall not constitute acceptance by the City.

The work shall also be subject to inspection by representatives of the City of Tuscaloosa Building Inspection Department.

B. **Observation of the Project:** The Engineer/Architect, the City and its observers, agents, any agency having jurisdiction, and their representatives shall have access at all times to the Project for inspection whenever it is in preparation or progress, and the Contractor shall provide proper facilities for such access and inspection. The City or the Engineer/Architect may appoint or assign observers, with designated duties and restricted authority, to inspect the Project as may be directed, or to make special observations requested in advance by the Contractor, and to report progress of the Project, and manner of procedure, quality of the material and workmanship, and compliance with the Contract Documents.

Inspection or observation is not acceptance and shall not constitute acceptance by the City.

All materials, workmanship, equipment, processes of manufacture, and methods of construction, shall be subject to inspection, examination, and test by such persons at any and all places where such manufacture and/or construction are being carried on. The Engineer/Architect shall have the right to reject material, workmanship and/or equipment that are defective or otherwise not in accordance with the drawings and Specifications and require its correction by the Contractor. Rejected workmanship shall be satisfactorily corrected, and rejected material shall be satisfactorily replaced with proper material by the Contractor without charge therefor, and the Contractor shall promptly segregate and remove the rejected material from the premises. Provided; however, neither the presence or absence of such observers nor the giving or failure to give such advice, direction or instruction shall in any manner relieve the Contractor from any contract requirement.

Upon rejection of material and/or workmanship by the Engineer/Architect or the City, there may be occasion where such deficiencies may be corrected more economically and timely through modification of the design versus removal and replacement. In such instances, the Engineer/Architect shall provide design services on behalf of the City necessary for analysis and correction of the rejected work. Costs associated with hourly fees for these professional

services shall be paid by the City and deducted from payment to the Contractor based on the actual costs incurred. Prior to beginning any analysis and accrual of associated professional service fees, the Engineer/Architect shall provide the Contractor and City notice in writing of the intent to begin, summary of the scope of work, estimated time to complete, and estimated total fees. Any costs associated with corrective work performed by the Contractor to remedy such deficiencies shall be the sole responsibility of the Contractor.

Neither the City observers nor the Engineer/Architect, will be authorized to revoke, alter, relax, or waive any requirements of the Contract Documents; to issue instructions contrary to the drawings and Specifications; nor shall they supervise and direct work for the Contractor, nor unreasonably interfere with the Contractor's operations beyond the extent necessary to make certain that the Project is being carried out according to the contract requirements.

Any advice which they may give the Contractor shall not be construed as binding the City in any way, nor as releasing the Contractor from any of the contract requirements.

If the Contractor considers any work demanded of it to be outside the contract requirements, or any ruling of the Engineer/Architect or an inspector to be unfair, it may immediately, upon such work being demanded or ruling made, request written instructions from the Engineer/Architect, or inspector, or within ten days file an appeal to the Engineer/Architect or the City, stating clearly and in detail the basis of its objections. However, pending the decision on such appeal no work shall be done in disregard of the rulings of the Engineer/Architect or inspector or his instructions on items of work affected by such appeal.

The Contractor shall furnish promptly, without extra compensation, all reasonable facilities, labor, and material necessary for safe and convenient access, inspection, and tests that may be required by the Engineer/Architect.

C. Authority and Duties of Observers: If City or consultant inspectors, whether for the Engineer/Architect or Construction Manager, are being utilized, they shall be authorized and permitted to inspect all work done. The Inspector shall not be authorized to alter or waive any requirements of the Specifications. He shall have authority to call the attention of the Contractor to failure of the work to conform to the specifications and Contract. He may suspend the Project until any questions at issue can be referred to and decided by the Engineer/Architect or the City.

Neither the Engineer/Architect, Inspector, the City or other representatives for the City shall be responsible in any way for construction means, methods or techniques, nor for the safety of the construction work, progress, or employees of the Contractor or any subcontractors, except as set forth in the Construction Manager contract, if applicable.

The presence of the Inspector shall not in any manner lessen the responsibility of the Contractor pursuant to this agreement.

D. Defective Work/Correction of Work by the City: The inspection of the work shall not relieve the Contractor of any of its obligations to fulfill its contract and defective work shall be made good, notwithstanding that such work has been previously inspected by the Engineer/Architect and accepted or estimated for payment. The failure of the Engineer/Architect or inspector to condemn improper workmanship shall not be considered as a waiver of any defect, whether known at the time or discovered later, or as preventing the City at any time subsequently from recovering damages for work actually defective. All work shall be guaranteed by the Contractor against defects in workmanship for a period of one year from date of final payment.

Upon failure and/or neglect by the Contractor to promptly prosecute or perform the work in accordance with the contract documents, including any requirements with respect to the construction schedule, plans or specifications, the City may, without prejudice to any other remedy it may have, correct such deficiencies and may deduct the actual cost thereof from payment, then or thereafter due to the Contractor.

E. Disagreement: Should any disagreement or difference arise as to the estimated quantities or classifications or as to the meaning of the drawings or specifications, or any point concerning the character, or acceptability or nature

of the several kinds of work, or construction thereof, the decision of the Engineer/Architect shall be final and conclusive and binding on the Contractor.

F. **Stop Work Orders:** During unseasonable weather all work must stop when the Engineer/Architect so directs and all work must be suitably protected by Contractor at all times. However, the Engineer/Architect shall be under no obligation to stop work on the Project. If the Project is stopped, the Contractor shall not be entitled to extra compensation for delays or problems associated with the stoppage.

G. **Progress Meetings:** The Contractor shall conduct regular progress meetings during the course of the Project at least once a month or more often if requested by the City or Engineer/Architect. The meetings shall be held at a site convenient to all parties and if a site cannot be agreed upon, the City will designate a site.

The Contractor or designated representative, the Contractor's Superintendent, all subcontractors, engineers, inspectors, and the City's representative shall attend.

The Contractor shall keep accurate written minutes of the meetings and forward copies thereof to the Engineer/Architect and the City's representative before the next scheduled meeting.

If a trade contract, progress meetings will be conducted by the Construction Manager, who will keep minutes. All trade contractors shall attend unless excused by the Construction Manager.

ARTICLE VII. PROJECT COMPLETION

A. **Substantial Completion:** "Substantial completion" shall be that degree of completion of the Project or a defined portion of the Project, as evidenced by the Engineer/Architect's written notice of Substantial Completion, sufficient to provide the City, at its discretion, the full-time use of the Project or defined portion of the work for the purposes for which it was intended. "Substantial Completion" of an operating facility or operating component of the Project shall be that degree of completion that has provided a minimum of seven (7) continuous days of successful, trouble-free operation in a "fully automatic" manner acceptable to the City and Engineer/Architect and with all redundant systems fully operational. All equipment contained in the Project, plus all other components necessary to enable the owner to operate the facility in the manner that was intended, shall be complete on the substantial completion date.

When the Contractor considers that the Project, or where acceptable to the City, a designated portion thereof is substantially complete, the Contractor shall prepare and submit to the Engineer/Architect a list of items to be completed or corrected and request an inspection for Substantial Completion. The failure by the Contractor to include any items on such list does not alter the responsibility of the Contractor to complete all work in accordance with the Contract Documents. After inspection and/or if an operating facility, after a minimum of seven (7) continuous days of successful, trouble free operation has been achieved during startup, the Engineer/Architect may, at his sole discretion, issue a written notice of substantial completion for the purpose of establishing the starting date for specific equipment guarantees or warranties, and to establish the date that the City will assume the responsibility for the cost of operating such equipment.

Said notice shall not be considered as final acceptance of any portion of the Project or relieve the Contractor from completing the remaining work, including any remaining performance or acceptance testing, within the specified time and in full compliance with the Contract Documents. Specifically, the issuance of a written notice of Substantial Completion shall not relieve the Contractor of his obligation to promptly remedy any omissions and latent or unnoticed defects in the Project covered by the written Notice of Substantial Completion.

B. **Final Inspection:** Upon notice from the Contractor that its work is complete, the Engineer/Architect and/or other representatives of the City shall make a final inspection of the work or Project and conduct test or tests if applicable. The Engineer/Architect shall notify the Contractor of all apparent and/or visible instances where the Project fails to comply with the plans and specifications and contract documents, as well as any defects he may discover (punch list). The Contractor shall immediately make such alterations as are necessary to make the Project comply with the plans and specifications and to the satisfaction of the Engineer/Architect.

Upon completion of all such repairs in a satisfactory manner, and when the Engineer/Architect has determined that the work or Project is acceptable under the contract, including this provision and after publication of final completion and all other requirements of final payment as provided for in this agreement, then he shall issue a final certificate of payment to the City stating that the balance is due the Contractor, less such amounts as may have been withheld by the City from time to time as provided in the contract documents. In recommending to the City that it make such final payment to the Contractor, the Engineer/Architect shall also issue a certificate of final acceptance wherein he shall recommend to the City that it accept the Project and/or work as final and complete pursuant to the contract documents.

Verification, approval, inspection, final inspection, issuance of final acceptance, issuance of final certificate of payment, action or approval by the City upon the final certificate of payment or final acceptance shall not in any way relieve the Contractor of responsibility for faulty materials or workmanship.

All warranty or guarantee periods shall commence and start to run from the date of substantial completion.

C. **"As Built" Drawings:** Unless waived by the City representative, the Contractor must provide to the City a set of "as built" drawings acceptable to the City as a component part of the Project prior to final payment.

D. **Final Cleanup:** Before final completion and final acceptance, the Contractor shall remove from the City's property or rights-of-ways and from all public and private property, all tools, scaffolding, false work, temporary structures and/or utilities, including the foundations thereof (except such as the City permits in writing to remain); rubbish and waste materials resulting from its operation or caused by its employees; and shall remove all surplus materials, leaving the site clean and true to line and grade, and the Project in a safe and clean condition ready for use and operation. In addition to the above, the Contractor shall be responsible for the following special cleaning for all trades as the Project shall have been completed:

1. Cleaning of all painted, enameled, stained or baked enamel work: removal of all marks, stains, fingerprints and splatters from such surfaces.
2. Cleaning of all glass: cleaning and removing of all stickers, labels, stains and paint from all glass and the washing and polishing of the same on interior and exterior.
3. Cleaning or polishing of all hardware.
4. Cleaning all tile, floor finishing of all kinds; removal of all splatters, stains, paint, dirt, and dust, the washing and polishing of all floors as recommended by the manufacturer or required by the Engineer/Architect.
5. Cleaning of all manufactured articles, materials, fixtures, appliances and equipment; removal of all stickers, rust stains, labels (except instructional and/or safety labels) and temporary covers and cleaning and conditioning of all manufactured articles, materials, fixtures, appliances, electrical, heating and air conditioning equipment as recommended or directed by the manufacturers, unless otherwise required by the Engineer/Architect; blowing out or flushing out of all foreign matter from all dust pockets, piping, tanks, pumps, fans, motors, devices, switches, panels, fixtures, boilers, similar features; and freeing identification plates on all equipment or excess paint and the polishing thereof.

In the case of failure to comply with the above requirements for any part of the Project within the time specified by the Engineer/Architect, he may cause the work to be done and deduct the cost thereof from the contract price on the next or succeeding application for payment, or in the event that the cost exceeds the balance due the Contractor, bill the Contractor for the excess.

E. **Notice of Completion:** The Contractor shall, immediately after the completion of the Project and acceptance by the Owner as provided for herein, give notice as required by Ala. Code §39-1-1(f) by an advertisement in some newspaper of general circulation published within the city or county wherein the Project has been done for a period of

four (4) successive weeks. The advertisement shall advise interested parties to contact both the Contractor and the specific City representative. The City's representative shall be named along with his proper mailing address. In no instance shall a final payment be made upon the contract until the expiration of thirty (30) days after the completion of the notice. Proof of publication of said notice shall be made by the Contractor to the City of Tuscaloosa by affidavit of the Publisher and a printed copy of the notice published.

Provided, however, that the requirements hereinabove stated for notice and advertisement shall not apply to contractors performing contracts of less than Fifty Thousand Dollars (\$50,000.00) in amount and the governing body of the City of Tuscaloosa so as to expedite final payment, shall cause notice of final completion of such contract to be published one time in Tuscaloosa County and shall post notice of final completion on the City of Tuscaloosa's bulletin board for one (1) week and shall require the Contractor to certify under oath that all bills have been paid in full. Final settlement with such Contractor may be made at any time after the notice shall have been posted for one (1) entire week.

NOTE: When maintenance periods are included in the contract for highways, bridges or similar structures, such periods shall be considered component parts of the contract.

F. Final Payment: Upon completion of the Project by the Contractor and acceptance by the City's representatives of all work required of the Contractor for the Project, but not until thirty (30) days after completion of the notice, the amount due the Contractor pursuant to the Contract Documents shall be paid upon the presentation by the Contractor to the City's representative of the following:

1. A properly executed and duly certified voucher for payment, verified by architect, engineer or other City representative, including therewith evidence that all payrolls and all amounts due for labor and materials, other than claims for damages due to tort, have been fully paid and satisfied and there are no outstanding claims or demands associated with the work on the Project.
2. A release of all claims and claims of lien against the City from the Contractor and all major subcontractors (the City may waive the requirement for subcontractor releases) arising under and by virtue of the contract, on the form attached, duly executed by the Contractor and with the consent of the surety. The Contractor may specifically except claims of the Contractor from the operation of the release if specifically excepted therefrom in stated amounts and the reason therefor. The Contractor may with the consent of the City representative, if any subcontractor refuses to furnish such a release, furnish a bond with surety satisfactory to the City representative to indemnify against such claims.
3. Proof of publication of notice of completion including affidavit of publisher and a printed copy of the notice so published, as provided by law.
4. In accordance with Ala. Code §39-2-12(c), a non-resident contractor shall satisfy the City that he or she has paid all taxes due and payable to the State, the City and all applicable political subdivisions.

G. Acceptance of Final Payment Constitutes Release: The acceptance by the Contractor of the final payment shall release the City, the Engineer/Architect, as representatives of the City, and their officers, employees, agents, and subconsultants from all claims and all liability to the Contractor for all things done or furnished in connection with the Project, and every act of the City and others relating to or arising out of the work except claims previously made in writing and still unsettled. No payment, however, final or otherwise, shall operate to release the Contractor or his Sureties from obligations under this Contract and the Performance Bond, Payment Bond, and other bonds, warranties and guarantees as herein provided.

ARTICLE VIII. WARRANTY AND GUARANTEES

A. Warranty and Guarantee:

1. **Warranty:** The Contractor warrants to the City and the Engineer/Architect that all materials and equipment furnished under this Contract will be new unless otherwise specified and that all work, materials and equipment will be of good quality, free from fault and defects and in conformance with the contract documents. The work must be safe, substantial and durable construction in all respects. All work, materials and equipment not conforming to these requirements, including substitutions not properly approved and authorized, may be considered defective. Warranties shall commence to run from the date of substantial completion.

The work furnished must be of first quality and the workmanship must be the best obtainable in the various trades. The Contractor hereby guarantees the Project and the work on the Project against defective materials or faulty workmanship for a minimum of one (1) year after final payment by the City and shall replace or repair any defective materials or equipment or faulty workmanship during the period of guarantee at no cost to the City.

2. **Guarantee:** If, within the designated warranty period or if not designated, within one (1) year from the date of substantial completion, any of the work, materials or equipment is found to be defective or not in accordance with the contract documents, the Contractor shall correct it promptly after receipt of written notice from the City to do so, unless the City has previously specifically given the Contractor a written acceptance of such specific condition. This obligation shall survive termination of the Contract. The City shall give such notice promptly after discovery of the condition.
3. **Roofing Guarantee:** If the Project involves a roof on a building or other structure, then the Contractor shall execute and provide the Roofing Guarantee in the form attached hereto. The guarantee shall be delivered to the City and Engineer/Architect prior to final payment.
4. **Termite Warranty:** If the Project involves termite treatment as required in Article IV, then the Contractor shall furnish to the City a written warranty certifying that the applied soil poisoning treatment will prevent the infestation of subterranean termites and that if subterranean termite activity is discovered during the warranty period, Contractor shall re-treat the soil and repair or replace any damage caused by termite infestation. The warranty shall be for a period of five (5) years from the date of treatment signed by Applicator and Contractor.

B. Correction of Defective Work During Warranty/Guarantee Period: The Contractor hereby agrees to make, at his own expense and no cost to the City, all repairs or replacements necessitated by defects in materials or workmanship, provided under the terms of this Contract, and pay for any damage to other works resulting from such defects, which become evident within 1 year after the date of substantial completion unless substantial completion is established by the Engineer/Architect only for specified items of equipment, or within such longer period of time as may be prescribed by law or by the terms of any applicable special guarantee required by the Contract Documents unless the City has previously given the Contractor a written acceptance of such defects. The Contractor shall promptly correct such defects upon receipt of a written notice from the City to do so. This obligation shall survive the termination of the Contract.

Unremedied defects identified for correction during the warranty period described herein before, but remaining after its expiration, shall be considered as part of the obligations of the warranty. Defects in material, workmanship, or equipment which are remedied as a result of obligations of the warranty shall subject the remedied portion of the Project to an extended warranty period of 1 year after the defect has been remedied.

Repetitive malfunction of equipment shall be cause for equipment replacement and an extension of the guarantee period for the equipment to a date 1 year following acceptable replacement.

The Contractor further assumes responsibility for a similar guarantee for all work and materials provided by subcontractors or manufacturers of packaged equipment components.

The Contractor also agrees to hold the City and the Engineer/Architect and employees harmless from liability or damages, including the Engineer/Architect's and attorneys' fees, and cost and expenses of litigation of any kind arising from damage due to said defects. The Contractor shall make all repairs and replacements promptly upon receipt of written order for same from the City. If the Contractor fails to make the repairs and replacements promptly, or in an emergency where delay would cause serious risk, or loss, or damage, the City may have the defective work corrected or the rejected work removed and replaced, and the Contractor and his Surety shall be liable for the cost thereof. The Contractor during the warranty period shall repair/replace as rapidly as possible any and all equipment, materials, etc., which are found to be defective. Should any items not be repaired/replaced within thirty (30) days from the time it is reported to the Contractor by the City, then the warranty period shall be extended on that item for a period equal to the time that the item has remained defective, incomplete, or inoperable as determined by the City. The Contractor must certify that the item has been corrected.

The City's rights under this Article shall be in addition to, and not a limitation of, any other rights and remedies available by law.

ARTICLE IX. LAWS, PERMITS, ETC.

A. Laws and Regulations/Royalties, Patents, Copyrights and Permits and Rights-of-Way: The Contractor shall comply with and keep itself fully informed of all laws, ordinances and regulations of federal, state, City and county in any manner effecting those engaged or employed in the Project, or the materials used in the Project, or in any way affecting the conduct of the Project, and of all orders and decrees of bodies or tribunals having any jurisdiction or authority over same. The Contractor shall possess all permits and licenses required by applicable law, rule or regulation for the performance of the Project. If any discrepancy or inconsistency should be discovered in this contract, or in the drawings or specifications herein referred to, in relation to any law, ordinance, regulation, order or decree, it shall forthwith report the same in writing to the Engineer/Architect. It shall at all times, itself, observe and comply with all such existing and future laws, ordinances and regulations.

The Contractor shall protect and indemnify the City, Engineer/Architect, and their respective employees, officers, subconsultants, and agents against any claim or liability arising from or based on the violation of any such laws, ordinances, or regulations. All permits, licenses, and inspection fees necessary for prosecution and completion of the Project shall be secured and paid for by the Contractor, unless otherwise specified.

The Contractor shall obtain and pay for all licenses and permits and shall pay all fees and charges for connection to outside service and the use of property required for the execution and completion of the Project.

The Contractor shall give all notices and comply with all laws, ordinances, rules, regulations, and code requirements applicable in or bearing on the conduct of the Project unless in conflict with contract requirements. If the Contractor ascertains at any time that any requirements of the Contract is at variance with applicable laws, ordinances, regulations, or building code requirements, it shall promptly notify the Engineer/Architect and any necessary adjustment of the Contract will be made as herein specified under change in orders.

The Contractor shall pay all applicable federal, state and local taxes and assessments on the Project. Wherever the law of the place of building requires a special tax, consumer, use, occupation, or other tax, the Contractor shall pay such tax.

The Contractor shall pay all royalties and license fees. The Contractor shall hold and save the City and its agents and employees harmless from liability of any nature or kind, including costs and expenses, for or on account of

any patented or unpatented invention, process, article or appliance manufactured or used in the performance of the contract, including its use by the City.

To the extent that the Project has not been permitted or registered by the Engineer or City, the Contractor shall register or obtain any and all necessary National Pollutant Discharge Elimination System (NPDES) Permits required by USEPA or the Alabama Department of Environmental Management (ADEM) as well as any applicable storm water permits or registration for the construction of the improvements specified in the Contract Documents. The Contractor shall abide by all regulations and conditions relative to the permit or registration and attachments to the permit or registration, including but not limited to sampling and monitoring. The Contractor shall fulfill for the City all the requirements made upon the City by the permit(s) or registration.

The Contractor shall be fully responsible for all aspects of erosion and sediment control. The Contractor shall utilize whatever measures are necessary to prevent pollution or siltation due to his activities. As a minimum, the Contractor shall strictly comply with the erosion control methods referenced in the Alabama Soil and Water Conservation Committee "Alabama Handbook for Erosion Control, Sediment Control, and Stormwater Management on Construction Sites and Urban Areas," latest edition (referred to as the "Alabama Handbook").

If the Contractor has information that any process, article or item specified or delineated by the Engineer/Architect is an infringement of a patent or a copyright, it shall promptly give such information to the Engineer/Architect.

B. Alabama Department of Transportation Rights-of-Way: If any portion of the Project involves work upon State right-of-way, the Contractor agrees to provide the Alabama Department of Transportation with a bond or certified check in the amount required, made payable to the Alabama Department of Transportation, to guarantee the faithful performance of the provisions of a permit and to guarantee that the Contractor shall maintain the work in a manner suitable to the Alabama Department of Transportation for a period of one (1) year. The Alabama Department of Transportation Bond Form must be used. At the end of one (1) year from the completion of this work, the Department of Transportation will return the certified check or bond to the applicant provided all provisions of this permit have been complied with. Otherwise, the Department of Transportation shall apply the certified check or bond to the cost of repairing the rights-of-way with State forces.

C. Tuscaloosa County Right-of-Way: If any portion of the Project involves work upon County right-of-way, the Contractor agrees to execute an application and file with Tuscaloosa County a bond or certified check in the amount required, made payable to Tuscaloosa County to guarantee the faithful performance of this provision of this work suitable to the County for a period of one (1) year. At the end of one year from the completion of this work, the County will return the certified check or bond to the applicant provided all provisions of this permit have been complied with. Otherwise, the County shall apply the certified check or bond on the cost of repairing the right-of-way with the County forces.

D. Storm Water Permit and Monitoring:

1. To the extent that the Project has not been permitted or registered by the Engineer or the City, and the Project is defined as an NPDES Construction Site per ADEM Admin. Code Chapter 335-6-12 (the Rule), the Contractor shall submit to the Alabama Department of Environmental Management (ADEM) a Notice of Registration (NOR) under the Rule for Storm Water Discharges during construction activities.
The Contractor shall strictly adhere to all requirements of the NOR and the rule regardless of which party has obtained coverage.
2. Compliance with all provisions of ADEM Admin. Code Chapter 335-6-12 and this registration is required, including but not limited to, the preparation and implementation of a Construction Best Management Practices Plan (CBMPP) and any other plans as may be required, the regular

maintenance of the Best Management Practices (BMPs) to the maximum extent practicable and the submittal of required reports. As required by the Rule, the Contractor shall retain a Qualified Credentialed Professional (QCP) to prepare the CBMPP and to certify that it was prepared in accordance with the requirements of the "Alabama Handbook" and the Rule.

3. This registration neither precludes nor negates an operator's responsibility or liability to apply for, obtain, or comply with other ADEM, federal, state, or local government permits, certifications, licenses, or other approvals.
4. The Contractor, unless application for registration has already been made, will be furnished a Storm Water NOR application package when the contract is awarded. The Storm Water NOR application package will include the following:
 - a. Typical transmittal letter to ADEM.
 - b. NOR applications filled out with Project information.
 - c. Project area map.
 - d. Other data as required by the NOR for Tier 1 waters if applicable.
5. The Contractor will complete or furnish the following items and submit to ADEM within five working days of the receipt of the NOR application provided by the Owner.
 - a. Information as outlined in the typical letter of transmittal, to the address indicated on the letter of transmittal, by registered mail or hand deliver.
 - b. The "Alabama Department of Environmental Management (ADEM), Field Operations Division Storm Water Program" Notice of Registration (NOR); NOR shall be signed by a responsible official who is the operator, owner, the sole proprietor of a sole proprietorship, a general/controlling member or partner, or an executive officer of at least the level of vice-president for a corporation. Additionally, the QCP is required to sign the CBMPP certification part of the NOR.
 - c. Determine applicable fee per ADEM Fee Schedule F and make check payable to: Alabama Department of Environmental Management for the NOR and submit to the Alabama Department of Environmental Management with the NOR application.
6. Application for the Storm Water Permit shall be made by the Contractor no later than five working days after receipt of application provided by Owner. The Contractor shall not commence any construction activities until ADEM has issued the authorization number for the Project.
7.
 - a. Payment will be made to the Contractor for obtaining the storm water NOR as specified herein for the lump sum amount as shown in the bid schedule. If there is no line item for registration, obtaining the NOR shall be considered a subsidiary obligation of mobilization.
 - b. Individual erosion and sediment control items shall be paid for at the unit prices as shown in the bid schedule. Routine inspections will be performed by the Owner's representative or Engineer to verify compliance with the CBMPP and the Rule shall be the Contractor's responsibility and shall be incidental to the storm water registration.
 - c. If no individual erosion and sediment control items are included in the bid schedule the cost of these items shall be incidental to the lump sum amount as shown in the bid schedule for Storm Water Monitoring and Temporary Erosion and Sediment Control and payment shall be made pro rata as the Project progresses.

E. The Contractor shall perform all work in compliance with and as required by any State, Federal or Local registration, permit or license, the terms and conditions of which are adopted herein by reference. The Contractor agrees to indemnify and hold harmless the City, Engineer, and their respective officers, agents and employees from any fines, penalties, damages, claims, liability or judgment arising out of or in any manner associated with the Contractor's failure to perform work on the Project in strict accordance with all storm water registration, permit or license requirements.

ARTICLE X. MISCELLANEOUS CLAUSES

A. Notice and Service Thereof:

1. All notices, demands, requests, change orders, instructions, approvals and claims shall be in writing. Unless expressly otherwise provided elsewhere in this agreement, any election, notice or other communication required or permitted to be given under this agreement shall be in writing and deemed to have been duly given if provided in accordance with the provisions hereof.
2. Any notice to or demand upon the Contractor shall be in writing and shall be sufficiently given if addressed to the Contractor at the address stated herein and deposited in the United States mail in a sealed envelope with sufficient postage prepaid or delivered with charges prepaid to any telegraph company for transmission to the Contractor at such address. It shall also be sufficient if such notice or demand be served upon the Contractor personally or its local representative in charge of the Project or delivered at his local office. The Contractor shall, from time to time, designate to the City in writing any change of address to which such notice or demand shall be sent.
3. Any notice to or demand upon the City shall be in writing and shall be sufficiently given if delivered to the office of the City's representative or if addressed to the City representative and deposited in the United States mail in a sealed envelope with sufficient postage prepaid or delivered with charges prepaid to any telegraph company for transmission to such representative of the City.

B. City Representative: The City's representative on this Project is hereby designated as Chris Casey and whose address is City of Tuscaloosa, P. O. Box 2089, Tuscaloosa, AL 35403. All references to Engineer or Architect shall be to the City representative if no Engineer or Architect is involved in the Project.

With a copy to: Glenda Webb, Esquire, City Attorney, Office of the City Attorney
City of Tuscaloosa, Post Office Box 2089, Tuscaloosa, Alabama 35403-2089
Telephone: (205) 248-5140, Facsimile: (205) 349-0328

C. Contractor Representative: The Contractor's representative on this Project is hereby designated as Tyler Roberts and whose address is Turner Plumbing, Inc., 1700 26th Avenue, Tuscaloosa, Alabama 35401.

D. Capacity: Each party to this agreement represents and warrants to the other as follows:

1. That it is an individual of the age of majority or otherwise a legal entity duly organized and in good standing pursuant to all applicable laws, rules and regulations.
2. That each has full power and capacity to enter into this agreement, to perform and to conclude the same including the capacity, to the extent applicable, to grant, convey and/or transfer; areas, assets, facilities, properties, (both real and personal), permits, consents and authorizations and/or the full power and right to acquire and accept the same.
3. That to the extent required, each party has obtained the necessary approval of its governing body or board and a resolution or other binding act has been duly and properly enacted by such governing body or board authorizing this agreement and said approval has been reduced to writing and certified or attested by the appropriate official of the party.
4. That each party has duly authorized and empowered a representative to execute this agreement on their respective behalf and the execution of this agreement by such representative fully and completely binds the party to the terms and conditions hereof.
5. That absent fraud, the execution of this agreement by a representative of the party shall constitute a certification that all such authorizations for execution exist and have been performed and the other party shall be entitled to rely upon the same. To the extent a party is a partnership, limited liability

company or joint venture, the execution of this agreement by any member thereof shall bind the party and to the extent that the execution of agreement is limited to a manager, managing partner or specific member then the person so executing this agreement is duly authorized to act in such capacity for the party.

6. That each party represents and warrants to the other that there is no litigation, claim or administrative action threatened or pending or other proceedings to its knowledge against it which would have an adverse impact upon this transaction or upon either's ability to conclude the transaction or perform pursuant to the terms and conditions of this agreement.
7. That each party has obtained any and all required permits, approvals and/or authorizations from third parties to enable it to fully perform pursuant to this agreement.
8. Under the provisions of the Constitution and laws of the State of Alabama, each party has the power to consummate the transactions contemplated by this agreement;
9. Each party represents and warrants that the execution and delivery of this agreement and the consummation of the transactions contemplated herein will not conflict with, be in violation of, or constitute (upon notice or lapse of time, or both) a default under the laws of the State of Alabama, any resolution, agreement, or other contract agreement, or instrument to which a party is subject, or any resolution, order, rule, regulation, writ, injunction, decree or judgment of any governmental authority or court having jurisdiction over the party.
10. This agreement constitutes the legal, valid and binding obligation of each party and is enforceable against each party in accordance with its terms, except in so far as the enforceability thereof may be limited by:
 - (a) Bankruptcy, insolvency or other similar laws affecting the enforcement of creditors' rights
 - (b) General principles of equity, regardless of whether such enforceability is considered as a proceeding at equity or at law.
11. Neither party will enter into any agreement to do anything prohibited in this agreement or enter into any agreement or take any action which would in any way impair the ability of the other party to faithfully and fully perform its obligations hereunder.
12. Under the provisions of the Constitution and laws of the State of Alabama, each party has the power to consummate the transactions contemplated by this agreement.

E. Ownership of Contract Documents: The Contract Documents, and copies of parts thereof, are furnished and owned either by the City or the Engineer/Architect. All portions of the Contract Documents, and copies of parts thereof, are the instruments of service for this Project. They are not to be used on other work and are to be returned to the City on request at the completion of the Project. Any reuse of these materials without specific written verification or adaptation by the City will be at the risk of the user and without liability or legal expense to the City or Engineer/Architect. Such user shall hold the City, its officers, agents and employees harmless from any and all damages, including reasonable attorneys' fees, from any and all claims arising from any such reuse. Any such verification and adoption shall entitle the City to further compensation at rates to be agreed upon by the user and the City.

F. No Waiver of Rights: Neither the inspection by the City or the Engineer/Architect or any of their officers, employees, agents, or subconsultants, nor any order by the City for payment of money, nor any payment for, or acceptance of, the whole or any part of the Project by the City or Engineer/Architect, nor any extension of time or change order, nor any possession taken by the City or its employees, or non enforcement of any provision of this agreement by either party shall operate as a waiver of any provision of this agreement, or any power herein reserved to the City, or any right to damages, nor shall any waiver of any breach in this agreement be held to be a waiver of any other or subsequent breach. Acceptance or final payment shall not be final and conclusive with regards to latent defects, fraud, or such gross mistakes as may amount to fraud, or as regards the City's rights under any warranty.

G. Subletting or Assigning of Contract:

1. **Limitations:** The Contractor shall not sublet, assign, transfer, convey, sell or otherwise dispose of any portion of the agreement, his obligations, right, or interest therein, or its power to execute such agreement, to any person, firm or corporation without written consent of the City and such written consent shall not be construed to relieve the Contractor of any duty or responsibility for the fulfillment of the agreement. A sale, conveyance or transfer of 50% or more of the stock or ownership of the Contractor shall be considered an assignment. Provided; however, in no event shall any portion of this agreement be assigned to an unsuccessful bidder whose bid was rejected because he or she was not a responsible or responsive bidder. Use of subcontracts up to a combined (total) value of 50 percent of the value of all work will not be construed as an assignment. Unless otherwise stipulated in the proposal or general conditions, the Contractor shall perform, with its own organization, work with the value not less than fifty (50) percent of the value of all work embraced in the contract.
2. **Subcontractor's Status:** A subcontractor shall be recognized only in the capacity of an employee or agent of the Contractor.

H. Third Party Beneficiaries: It is the intent of the parties hereto that there shall be no third party beneficiaries to this agreement.

I. Final Integration: This Agreement constitutes the entire agreement of the parties, as a complete and final integration thereof with respect to its subject matter. All written or oral understandings and agreements heretofore had between and among the parties are merged into this Agreement, which alone fully and completely expresses their understandings. No representation, warranty, or covenant made by any party which is not contained in this Agreement or expressly referred to herein has been relied on by any party in entering into this Agreement.

J. Force Majeure: Neither party to this Agreement shall hold the other party responsible for damages or delay in performance caused by acts of God, strikes, lockouts or other circumstances beyond the reasonable control of the other or the other party's employees, agents or contractors.

K. Amendment in Writing: This Agreement may not be amended, modified, altered, changed, terminated, or waived in any respect whatsoever, except by a further agreement in writing, properly executed by all of the parties.

L. Binding Effect: This agreement shall bind the parties and their respective personal representatives, heirs, next of kin, legatees, distributees, successors, and assigns.

M. Captions: The captions of this Agreement are for convenience and reference only, are not a part of this Agreement, and in no way define, describe, extend, or limit the scope or intent of this Agreement.

N. Construction: This Agreement shall be construed in its entirety according to its plain meaning and shall not be construed against the party who provided or drafted it.

O. Mandatory and Permissive: "Shall", "will", and "agrees" are mandatory; "may" is permissive.

P. Governing Laws: The laws of the State of Alabama shall govern the validity of this Agreement, the construction of its terms, the interpretation of the rights, the duties of the parties, the enforcement of its terms, and all other matters relating to this Agreement.

Q. Liability of the City or City Officials. Notwithstanding any provision hereof to the contrary, the parties agree and acknowledge that the liability and obligations of the City, City officials or City employees as set forth herein are subject to the limitations imposed on municipalities by the Constitution and laws of the State of Alabama. No present or future official, officer or employee of the City shall ever be personally liable for the performance of any obligations hereunder.

R. **Non Discrimination:** The Contractor agrees that in performing the work and services as required herein under this agreement, not to discriminate against any person on the basis of race color, religion, sex, age or disability. (The Contractor shall fully comply with the Americans with Disabilities Act), the Fair Labor Standards Act and all other applicable laws and regulations).

S. **Fines and Penalties:** The Contractor shall be solely liable for any and all fines or penalties which may be levied by any governmental authority against the Owner and/or Contractor which are related to the Contractor's operations. The Owner shall deduct the amount of the levied fine or penalty from the Contract amount.

T. **Agreement Date/Counterparts:** The date of this Agreement is intended as and for a date for the convenient identification of this Agreement and is not intended to indicate that this Agreement was necessarily executed and delivered on said date. This instrument may be executed in any number of counterparts, each of which so executed shall be deemed an original, but all such counterparts shall together constitute but one and the same instrument.

U. **Use of Words and Phrases.** The following words and phrases, where used in this document, shall be given the following and respective interpretations: "Herein," "hereby," "hereunder," "hereof," and other equivalent words refer to this document as an entirety and not solely to the particular portion hereof in which any such word is used.

The definitions set forth in any portion of this Agreement unless the text or context indicates differently shall be deemed applicable whether the words defined are herein used in the singular or the plural. Wherever used herein any pronoun or pronouns shall be deemed to include both singular and plural and to cover all genders.

V. **Severability.** Each provision of this agreement shall be considered to be severable and, if for any reason, any such provision or any part thereof, is determined to be invalid and contrary to any existing or future applicable law, such invalidity shall not impair the operation of or affect those portions of this agreement that are valid, but this agreement shall be construed and enforced in all respects as if the invalid or unenforceable provision or part thereof had been omitted.

IN TESTIMONY WHEREOF, said Contractor has hereto affixed its signature and said City of Tuscaloosa has caused these presents to be executed by Walter Maddox, Mayor of the City of Tuscaloosa, and attested by the City Clerk, on the day and year first above written, in four counterparts, each of which shall, without proof or accounting for the other, be accepted as an original.



ATTEST

PARTY OF THE FIRST PART

TURNER PLUMBING, INC.

Contractor

BY
ITS:



CITY OF TUSCALOOSA, A MUNICIPAL CORPORATION/PARTY OF THE SECOND PART/CITY, OWNER

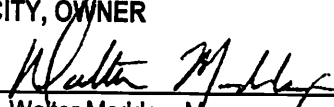

Walter Maddox, Mayor

ATTEST:



City Clerk

AMERICAN STATE
ACCOMMODATION SERVICE

... ..
... ..
... ..

... ..
... ..
... ..

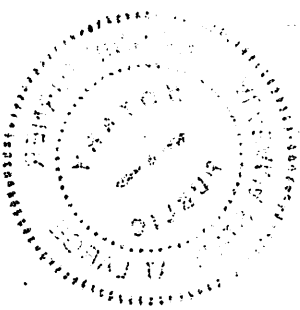

... ..
... ..

AMERICAN STATE
ACCOMMODATION SERVICE

... ..
... ..
... ..

... ..

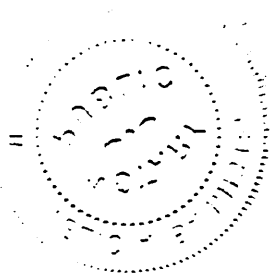

... ..
... ..

... ..

... ..

STATE OF ALABAMA)
COUNTY OF TUSCALOOSA)

I, Connie Turner, a Notary Public in and for said State at Large, hereby certify that Ricky Turner, who is named as President, is signed to the foregoing document, and,

- Who is known to me, or
- Whose identity I proved on the basis of _____, or
- Whose identity I proved on the oath/affirmation of _____, a creditable witness to the signer of the above document

and that being informed of the contents of the document, he/she, as such officer and with full authority, executed the same voluntarily on the day the same bears date.

Given under my hand and official seal this the 26th day of May, 20 17

Connie Turner
Notary Public.

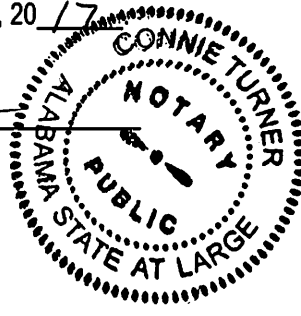

My Commission Expires: 6/10/20

STATE OF ALABAMA)
COUNTY OF TUSCALOOSA)

Before me, the undersigned, a Notary Public in and for the State of Alabama, appeared Walter Maddox, Mayor of the City of Tuscaloosa and acknowledged that his signature is affixed hereto in his capacity as Mayor of the City of Tuscaloosa.

Done this the 28th day of June, 20 17.

Zelicia Bannister
Notary Public in and for the State of Alabama at Large

My Commission Expires: 7-14-2020

[END OF CONTRACT AGREEMENT OFFICE OF THE CITY ATTORNEY]

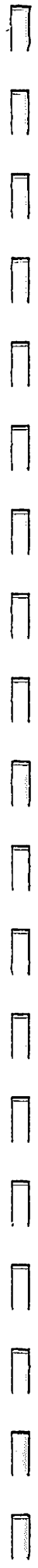
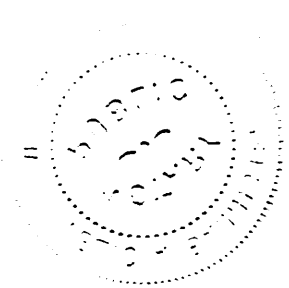
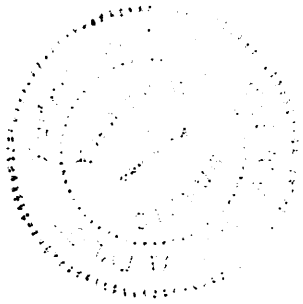

CITY OF TUSCALOOSA PUBLIC WORKS CONTRACT DOCUMENTS
SECTION SIX
PERFORMANCE BONDS
(2017)

STATE OF ALABAMA)
TUSCALOOSA, COUNTY)

KNOWN ALL MEN BY THESE PRESENTS, that we, Turner Plumbing, Inc.
as principal and Travelers Casualty and Surety Company of America (hereinafter called the "Surety"), as
surety, do hereby acknowledge ourselves indebted and firmly bound and held unto the City of Tuscaloosa, Alabama,
(hereinafter called the "City") a municipal corporation existing under and by virtue of the laws of the State of Alabama,
for the use and benefit of those entitled thereto, in the penal sum of \$178,500.00
for the payment of which well and truly be made in lawful money of the United States, we do hereby bind ourselves,
our successors and assigns and personal representatives, jointly and severally, firmly by the presents.

BUT THE CONDITION OF THE FOREGOING OBLIGATION OR BOND IS THIS:

WHEREAS, the City has entered into a certain written contract with said Contractor for the _____
The EDGE Business Resource Center, Trade Package 8 - Plumbing in accordance with contract documents therefore
on file in the Office of the City Representative at the price of, to-wit: _____
One Hundred Seventy-eight Thousand Five Hundred & No/100ths (\$178,500.00) as more fully appears in said
written contract bearing the date of June 28, 2017, which contract is hereby
referred to and made a part hereof to the same extent as if set out herein in full.

NOW, THEREFORE, if the Contractor shall fully and faithfully perform all the undertakings and obligations
under the said agreement or contract herein before referred to and shall fully indemnify and save harmless the said
City from all costs and damages whatsoever which it may suffer by reason of any failure on the part of said Contractor
so to do, and shall fully reimburse and repay the said City any and all outlay and expense which it may incur in making
good any such default, and shall guarantee all workmanship against defects for a period of one year, this obligation or
bond shall be null and void, otherwise it shall remain in full force and effect.

And, for value received it is hereby stipulated and agreed that no change, extension of time, alteration or
addition to the terms of said agreement or contract or in the work to be performed thereunder or the specifications
accompanying the same shall in any wise affect the obligations of the principal or of the surety under this bond, and
notice is hereby waived of any such change, extension of time, alternative of or addition to the terms of the agreement
or contract or to the work or to the specifications.

IN WITNESS WHEREOF, the said Contractor has hereunder affixed its signature and said Surety has
hereunto caused to be affixed its corporate signature and seal, by its duly authorized officers on the 28th day of
June, 2017

Turner Plumbing, Inc.
Principal
By [Signature]
Title

Travelers Casualty and Surety Company of America
Surety
By [Signature]
Julie Tubbs, Attorney-in-Fact
Title

ATTEST:
[Signature]



POWER OF ATTORNEY

Farmington Casualty Company
Fidelity and Guaranty Insurance Company
Fidelity and Guaranty Insurance Underwriters, Inc.
St. Paul Fire and Marine Insurance Company
St. Paul Guardian Insurance Company

St. Paul Mercury Insurance Company
Travelers Casualty and Surety Company
Travelers Casualty and Surety Company of America
United States Fidelity and Guaranty Company

Attorney-In Fact No. 230377

Certificate No. 007022736

KNOW ALL MEN BY THESE PRESENTS: That Farmington Casualty Company, St. Paul Fire and Marine Insurance Company, St. Paul Guardian Insurance Company, St. Paul Mercury Insurance Company, Travelers Casualty and Surety Company, Travelers Casualty and Surety Company of America, and United States Fidelity and Guaranty Company are corporations duly organized under the laws of the State of Connecticut, that Fidelity and Guaranty Insurance Company is a corporation duly organized under the laws of the State of Iowa, and that Fidelity and Guaranty Insurance Underwriters, Inc., is a corporation duly organized under the laws of the State of Wisconsin (herein collectively called the "Companies"), and that the Companies do hereby make, constitute and appoint

Timothy L. Donahue, T. Gary Fitts, J. David Fitts, Charles F. Horton Jr., R. Forrest Fitts, Cheryl Camak, Julie Tubbs, and Chris Davidson

of the City of Tuscaloosa, State of Alabama, their true and lawful Attorney(s)-in-Fact, each in their separate capacity if more than one is named above, to sign, execute, seal and acknowledge any and all bonds, recognizances, conditional undertakings and other writings obligatory in the nature thereof on behalf of the Companies in their business of guaranteeing the fidelity of persons, guaranteeing the performance of contracts and executing or guaranteeing bonds and undertakings required or permitted in any actions or proceedings allowed by law.

The authority granted hereunder to sign, execute, seal and acknowledge any individual bond, recognizance, conditional undertaking, and other writing obligatory in the nature thereof is limited to the sum of TEN MILLION (\$10,000,000.00) DOLLARS per bond.

IN WITNESS WHEREOF, the Companies have caused this instrument to be signed and their corporate seals to be hereto affixed, this 24th day of October, 2016.

Farmington Casualty Company
Fidelity and Guaranty Insurance Company
Fidelity and Guaranty Insurance Underwriters, Inc.
St. Paul Fire and Marine Insurance Company
St. Paul Guardian Insurance Company

St. Paul Mercury Insurance Company
Travelers Casualty and Surety Company
Travelers Casualty and Surety Company of America
United States Fidelity and Guaranty Company



State of Connecticut
City of Hartford ss.

By: [Signature]
Robert L. Raney, Senior Vice President

On this the 24th day of October, 2016, before me personally appeared Robert L. Raney, who acknowledged himself to be the Senior Vice President of Farmington Casualty Company, Fidelity and Guaranty Insurance Company, Fidelity and Guaranty Insurance Underwriters, Inc., St. Paul Fire and Marine Insurance Company, St. Paul Guardian Insurance Company, St. Paul Mercury Insurance Company, Travelers Casualty and Surety Company, Travelers Casualty and Surety Company of America, and United States Fidelity and Guaranty Company, and that he, as such, being authorized so to do, executed the foregoing instrument for the purposes therein contained by signing on behalf of the corporations by himself as a duly authorized officer.

In Witness Whereof, I hereunto set my hand and official seal. My Commission expires the 30th day of June, 2021.



[Signature]
Marie C. Tetreault, Notary Public

This Power of Attorney is granted under and by the authority of the following resolutions adopted by the Boards of Directors of Farmington Casualty Company, Fidelity and Guaranty Insurance Company, Fidelity and Guaranty Insurance Underwriters, Inc., St. Paul Fire and Marine Insurance Company, St. Paul Guardian Insurance Company, St. Paul Mercury Insurance Company, Travelers Casualty and Surety Company, Travelers Casualty and Surety Company of America, and United States Fidelity and Guaranty Company, which resolutions are now in full force and effect, reading as follows:

RESOLVED, that the Chairman, the President, any Vice Chairman, any Executive Vice President, any Senior Vice President, any Vice President, any Second Vice President, the Treasurer, any Assistant Treasurer, the Corporate Secretary or any Assistant Secretary may appoint Attorneys-in-Fact and Agents to act for and on behalf of the Company and may give such appointee such authority as his or her certificate of authority may prescribe to sign with the Company's name and seal with the Company's seal bonds, recognizances, contracts of indemnity, and other writings obligatory in the nature of a bond, recognizance, or conditional undertaking, and any of said officers or the Board of Directors at any time may remove any such appointee and revoke the power given him or her; and it is

FURTHER RESOLVED, that the Chairman, the President, any Vice Chairman, any Executive Vice President, any Senior Vice President or any Vice President may delegate all or any part of the foregoing authority to one or more officers or employees of this Company, provided that each such delegation is in writing and a copy thereof is filed in the office of the Secretary; and it is

FURTHER RESOLVED, that any bond, recognizance, contract of indemnity, or writing obligatory in the nature of a bond, recognizance, or conditional undertaking shall be valid and binding upon the Company when (a) signed by the President, any Vice Chairman, any Executive Vice President, any Senior Vice President or any Vice President, any Second Vice President, the Treasurer, any Assistant Treasurer, the Corporate Secretary or any Assistant Secretary and duly attested and sealed with the Company's seal by a Secretary or Assistant Secretary; or (b) duly executed (under seal, if required) by one or more Attorneys-in-Fact and Agents pursuant to the power prescribed in his or her certificate or their certificates of authority or by one or more Company officers pursuant to a written delegation of authority; and it is

FURTHER RESOLVED, that the signature of each of the following officers: President, any Executive Vice President, any Senior Vice President, any Vice President, any Assistant Vice President, any Secretary, any Assistant Secretary, and the seal of the Company may be affixed by facsimile to any Power of Attorney or to any certificate relating thereto appointing Resident Vice Presidents, Resident Assistant Secretaries or Attorneys-in-Fact for purposes only of executing and attesting bonds and undertakings and other writings obligatory in the nature thereof, and any such Power of Attorney or certificate bearing such facsimile signature or facsimile seal shall be valid and binding upon the Company and any such power so executed and certified by such facsimile signature and facsimile seal shall be valid and binding on the Company in the future with respect to any bond or understanding to which it is attached.

I, Kevin E. Hughes, the undersigned, Assistant Secretary, of Farmington Casualty Company, Fidelity and Guaranty Insurance Company, Fidelity and Guaranty Insurance Underwriters, Inc., St. Paul Fire and Marine Insurance Company, St. Paul Guardian Insurance Company, St. Paul Mercury Insurance Company, Travelers Casualty and Surety Company, Travelers Casualty and Surety Company of America, and United States Fidelity and Guaranty Company do hereby certify that the above and foregoing is a true and correct copy of the Power of Attorney executed by said Companies, which is in full force and effect and has not been revoked.

IN TESTIMONY WHEREOF, I have hereunto set my hand and affixed the seals of said Companies this _____ day of _____, 20 ____.

WARNING: THIS POWER OF ATTORNEY IS INVALID WITHOUT THE RED BORDER

Kevin E. Hughes
Kevin E. Hughes, Assistant Secretary



To verify the authenticity of this Power of Attorney, call 1-800-421-3880 or contact us at www.travelersbond.com. Please refer to the Attorney-In-Fact number, the above-named individuals and the details of the bond to which the power is attached.

CITY OF TUSCALOOSA PUBLIC WORKS CONTRACT DOCUMENTS

**SECTION SEVEN
LABOR AND MATERIAL BOND
(2017)**

KNOWN ALL MEN BY THESE PRESENTS, that we, Turner Plumbing, Inc.
(hereinafter called the "Contractor") of P.O Box 1276, Tuscaloosa, AL 35403
as principal and Travelers Casualty and Surety Company of America (hereinafter called the
"Surety"), as surety, do hereby acknowledge ourselves indebted and firmly bound and held unto the City of Tuscaloosa,
Alabama, (hereinafter called the "City"), a municipal corporation, existing under and by virtue of the Laws of the State
of Alabama, for the use and benefit of those entitled thereto, in the penal sum of _____
One Hundred Seventy-eight Thousand Five Hundred & No/100ths (\$178,500.00
_____) for the payment of which well and truly to be made in lawful money of the United States, we do
hereby bind ourselves, or successors, assigns and personal representatives, jointly and severally, firmly by these
presents.

BUT THE CONDITION OF THE FOREGOING OBLIGATION OR BOND IS THIS:

WHEREAS: the City has entered into a certain written contract with said Contractor for the
The EDGE Business Resource Center, Trade Package 8 - Plumbing in accordance with contract documents therefore on file
in the Office of the City Representative at the price of, to-wit:
One Hundred Seventy-eight Thousand Five Hundred & No/100ths (\$178,500.00)
as more fully appears in said written contract bearing date of June 28, 2017, which contract is
hereby referred to and made a part hereof to the same extent as if set out herein in full.

NOW, THEREFORE, if said Principal and all subcontractors to whom any portion of the work provided for in
said contract is sublet and all assignees of said Principal and of such subcontractors shall promptly make payment to
all persons supplying him or them with labor, foodstuffs, or supplies for or in the prosecution of the work provided for
in such contract, or in any amendment or extension of or addition to said contract, and for the payment of reasonable
attorney's fees, incurred by the claimant or claimants in suits on said bond, then the above obligation shall be void;
otherwise, it shall remain in full force and effect.

PROVIDED, however, that this bond is subject to the following conditions and limitations:

(a) Any person, firm or corporation that has furnished labor, foodstuffs, or supplies for or in the
prosecution of the work provided for in said contract, payment for which has not been made, shall have a direct right
of action in his or their name or names against the principal and surety on this bond, which right of action shall be
asserted in a proceeding, instituted in the county in which the work provided for in said contract is to be performed and
in any county in which said Principal or Surety does business. Such right of action shall be asserted in a proceeding
instituted in the name of the claimant or claimants for his or their use and benefit against said Principal and Surety or
either of them (but not later than one year after the final settlement of said Contract) in which action such claim or
claims shall be adjudicated and judgment rendered thereon.

(b) In addition to any other legal mode of service, service of summons and other process in suits on this
bond brought in Tuscaloosa County may be had on the Principal or the Surety in accordance with Title 27, Chapter 3,
Section 24 of the Ala. Code (1975) by serving a copy of the summons and complaint or other pleading or process,
with the Commissioner of Insurance of the State of Alabama or his/ her designee and the Principal and Surety agree
to be bound by such mode of service above described and consents that such service shall be the same as personal
service on the Principal or Surety.

(c) The Surety shall not be liable hereunder for any damages or compensation recoverable under any workmen's compensation or employer's liability statute.

(d) In no event shall the Surety be liable for a greater sum than the penalty of this bond, or subject to any suit, action or proceeding thereon that is instituted later than one year after the final settlement of said contract.

(e) This bond is given pursuant to the terms of Title 39, Chapter 1, Section 1 of the Ala. Code (1975), and all the provisions of law with reference to this character of bond as set forth in said section or as may hereinafter be enacted are hereby made a part hereof to the same extent as if set out herein in full.

IN WITNESS WHEREOF, the said Contractor has hereunder affixed its signature and said Surety has hereunto caused to be affixed its corporate signature and seal, by its duly authorized officers on the 28th day of June, 2017.

Turner Plumbing, Inc.
Principal

By: 
President
Title

Travelers Casualty and Surety Company of America
Surety

By: 
Julie Tubbs, Attorney-in-Fact
Title

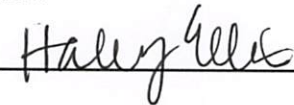
ATTEST:



POWER OF ATTORNEY

Farmington Casualty Company
Fidelity and Guaranty Insurance Company
Fidelity and Guaranty Insurance Underwriters, Inc.
St. Paul Fire and Marine Insurance Company
St. Paul Guardian Insurance Company

St. Paul Mercury Insurance Company
Travelers Casualty and Surety Company
Travelers Casualty and Surety Company of America
United States Fidelity and Guaranty Company

Attorney-In Fact No. 230377

Certificate No. 007022737

KNOW ALL MEN BY THESE PRESENTS: That Farmington Casualty Company, St. Paul Fire and Marine Insurance Company, St. Paul Guardian Insurance Company, St. Paul Mercury Insurance Company, Travelers Casualty and Surety Company, Travelers Casualty and Surety Company of America, and United States Fidelity and Guaranty Company are corporations duly organized under the laws of the State of Connecticut, that Fidelity and Guaranty Insurance Company is a corporation duly organized under the laws of the State of Iowa, and that Fidelity and Guaranty Insurance Underwriters, Inc., is a corporation duly organized under the laws of the State of Wisconsin (herein collectively called the "Companies"), and that the Companies do hereby make, constitute and appoint

Timothy L. Donahue, T. Gary Fitts, J. David Fitts, Charles F. Horton Jr., R. Forrest Fitts, Cheryl Camak, Julie Tubbs, and Chris Davidson

of the City of Tuscaloosa, State of Alabama, their true and lawful Attorney(s)-in-Fact, each in their separate capacity if more than one is named above, to sign, execute, seal and acknowledge any and all bonds, recognizances, conditional undertakings and other writings obligatory in the nature thereof on behalf of the Companies in their business of guaranteeing the fidelity of persons, guaranteeing the performance of contracts and executing or guaranteeing bonds and undertakings required or permitted in any actions or proceedings allowed by law.

The authority granted hereunder to sign, execute, seal and acknowledge any individual bond, recognizance, conditional undertaking, and other writing obligatory in the nature thereof is limited to the sum of TEN MILLION (\$10,000,000.00) DOLLARS per bond.

IN WITNESS WHEREOF, the Companies have caused this instrument to be signed and their corporate seals to be hereto affixed, this 24th day of October, 2016.

Farmington Casualty Company
Fidelity and Guaranty Insurance Company
Fidelity and Guaranty Insurance Underwriters, Inc.
St. Paul Fire and Marine Insurance Company
St. Paul Guardian Insurance Company

St. Paul Mercury Insurance Company
Travelers Casualty and Surety Company
Travelers Casualty and Surety Company of America
United States Fidelity and Guaranty Company



State of Connecticut
City of Hartford ss.

By: [Signature]
Robert L. Raney, Senior Vice President

On this the 24th day of October, 2016, before me personally appeared Robert L. Raney, who acknowledged himself to be the Senior Vice President of Farmington Casualty Company, Fidelity and Guaranty Insurance Company, Fidelity and Guaranty Insurance Underwriters, Inc., St. Paul Fire and Marine Insurance Company, St. Paul Guardian Insurance Company, St. Paul Mercury Insurance Company, Travelers Casualty and Surety Company, Travelers Casualty and Surety Company of America, and United States Fidelity and Guaranty Company, and that he, as such, being authorized so to do, executed the foregoing instrument for the purposes therein contained by signing on behalf of the corporations by himself as a duly authorized officer.

In Witness Whereof, I hereunto set my hand and official seal.
My Commission expires the 30th day of June, 2021.



[Signature]
Marie C. Tetreault, Notary Public

This Power of Attorney is granted under and by the authority of the following resolutions adopted by the Boards of Directors of Farmington Casualty Company, Fidelity and Guaranty Insurance Company, Fidelity and Guaranty Insurance Underwriters, Inc., St. Paul Fire and Marine Insurance Company, St. Paul Guardian Insurance Company, St. Paul Mercury Insurance Company, Travelers Casualty and Surety Company, Travelers Casualty and Surety Company of America, and United States Fidelity and Guaranty Company, which resolutions are now in full force and effect, reading as follows:

RESOLVED, that the Chairman, the President, any Vice Chairman, any Executive Vice President, any Senior Vice President, any Vice President, any Second Vice President, the Treasurer, any Assistant Treasurer, the Corporate Secretary or any Assistant Secretary may appoint Attorneys-in-Fact and Agents to act for and on behalf of the Company and may give such appointee such authority as his or her certificate of authority may prescribe to sign with the Company's name and seal with the Company's seal bonds, recognizances, contracts of indemnity, and other writings obligatory in the nature of a bond, recognizance, or conditional undertaking, and any of said officers or the Board of Directors at any time may remove any such appointee and revoke the power given him or her; and it is

FURTHER RESOLVED, that the Chairman, the President, any Vice Chairman, any Executive Vice President, any Senior Vice President or any Vice President may delegate all or any part of the foregoing authority to one or more officers or employees of this Company, provided that each such delegation is in writing and a copy thereof is filed in the office of the Secretary; and it is

FURTHER RESOLVED, that any bond, recognizance, contract of indemnity, or writing obligatory in the nature of a bond, recognizance, or conditional undertaking shall be valid and binding upon the Company when (a) signed by the President, any Vice Chairman, any Executive Vice President, any Senior Vice President or any Vice President, any Second Vice President, the Treasurer, any Assistant Treasurer, the Corporate Secretary or any Assistant Secretary and duly attested and sealed with the Company's seal by a Secretary or Assistant Secretary; or (b) duly executed (under seal, if required) by one or more Attorneys-in-Fact and Agents pursuant to the power prescribed in his or her certificate or their certificates of authority or by one or more Company officers pursuant to a written delegation of authority; and it is

FURTHER RESOLVED, that the signature of each of the following officers: President, any Executive Vice President, any Senior Vice President, any Vice President, any Assistant Vice President, any Secretary, any Assistant Secretary, and the seal of the Company may be affixed by facsimile to any Power of Attorney or to any certificate relating thereto appointing Resident Vice Presidents, Resident Assistant Secretaries or Attorneys-in-Fact for purposes only of executing and attesting bonds and undertakings and other writings obligatory in the nature thereof, and any such Power of Attorney or certificate bearing such facsimile signature or facsimile seal shall be valid and binding upon the Company and any such power so executed and certified by such facsimile signature and facsimile seal shall be valid and binding on the Company in the future with respect to any bond or understanding to which it is attached.

I, Kevin E. Hughes, the undersigned, Assistant Secretary, of Farmington Casualty Company, Fidelity and Guaranty Insurance Company, Fidelity and Guaranty Insurance Underwriters, Inc., St. Paul Fire and Marine Insurance Company, St. Paul Guardian Insurance Company, St. Paul Mercury Insurance Company, Travelers Casualty and Surety Company, Travelers Casualty and Surety Company of America, and United States Fidelity and Guaranty Company do hereby certify that the above and foregoing is a true and correct copy of the Power of Attorney executed by said Companies, which is in full force and effect and has not been revoked.

IN TESTIMONY WHEREOF, I have hereunto set my hand and affixed the seals of said Companies this _____ day of _____, 20 ____.

WARNING: THIS POWER OF ATTORNEY IS INVALID WITHOUT THE RED BORDER

Kevin E. Hughes
Kevin E. Hughes, Assistant Secretary



To verify the authenticity of this Power of Attorney, call 1-800-421-3880 or contact us at www.travelersbond.com. Please refer to the Attorney-In-Fact number, the above-named individuals and the details of the bond to which the power is attached.

CITY OF TUSCALOOSA PUBLIC WORKS CONTRACT DOCUMENTS
SECTION SIX
PERFORMANCE BONDS
(2017)

STATE OF ALABAMA)
TUSCALOOSA, COUNTY)

KNOWN ALL MEN BY THESE PRESENTS, that we, _____
as principal and _____ (hereinafter called the "Surety"), as
surety, do hereby acknowledge ourselves indebted and firmly bound and held unto the City of Tuscaloosa, Alabama,
(hereinafter called the "City") a municipal corporation existing under and by virtue of the laws of the State of Alabama,
for the use and benefit of those entitled thereto, in the penal sum of _____
for the payment of which well and truly be made in lawful money of the United States, we do hereby bind ourselves,
our successors and assigns and personal representatives, jointly and severally, firmly by the presents.

BUT THE CONDITION OF THE FOREGOING OBLIGATION OR BOND IS THIS:

WHEREAS, the City has entered into a certain written contract with said Contractor for the _____
_____ in accordance with contract documents therefore
on file in the Office of the _____ at the price of, to-wit: _____
_____ (\$ _____) as more fully appears in said
written contract bearing the date of _____, 20____, which contract is hereby
referred to and made a part hereof to the same extent as if set out herein in full.

NOW, THEREFORE, if the Contractor shall fully and faithfully perform all the undertakings and obligations
under the said agreement or contract herein before referred to and shall fully indemnify and save harmless the said
City from all costs and damages whatsoever which it may suffer by reason of any failure on the part of said Contractor
so to do, and shall fully reimburse and repay the said City any and all outlay and expense which it may incur in making
good any such default, and shall guarantee all workmanship against defects for a period of one year, this obligation or
bond shall be null and void, otherwise it shall remain in full force and effect.

And, for value received it is hereby stipulated and agreed that no change, extension of time, alteration or
addition to the terms of said agreement or contract or in the work to be performed thereunder or the specifications
accompanying the same shall in any wise affect the obligations of the principal or of the surety under this bond, and
notice is hereby waived of any such change, extension of time, alternative of or addition to the terms of the agreement
or contract or to the work or to the specifications.

IN WITNESS WHEREOF, the said Contractor has hereunder affixed its signature and said Surety has
hereunto caused to be affixed its corporate signature and seal, by its duly authorized officers on the _____ day of
_____, 20_____.

Principal
By _____
Title

Surety
By _____

ATTEST:

Title

CITY OF TUSCALOOSA PUBLIC WORKS CONTRACT DOCUMENTS

SECTION SEVEN
LABOR AND MATERIAL BOND
(2017)

KNOWN ALL MEN BY THESE PRESENTS, that we, _____
(hereinafter called the "Contractor") of _____
as principal and _____ (hereinafter called the
"Surety"), as surety, do hereby acknowledge ourselves indebted and firmly bound and held unto the City of Tuscaloosa,
Alabama, (hereinafter called the "City"), a municipal corporation, existing under and by virtue of the Laws of the State
of Alabama, for the use and benefit of those entitled thereto, in the penal sum of _____
_____ (\$ _____
_____) for the payment of which well and truly to be made in lawful money of the United States, we do
hereby bind ourselves, or successors, assigns and personal representatives, jointly and severally, firmly by these
presents.

BUT THE CONDITION OF THE FOREGOING OBLIGATION OR BOND IS THIS:

WHEREAS: the City has entered into a certain written contract with said Contractor for the
_____, in accordance with contract documents therefore on file
in the Office of the _____ at the price of, to-wit:
_____ (\$ _____)
as more fully appears in said written contract bearing date of _____, 20____, which contract is
hereby referred to and made a part hereof to the same extent as if set out herein in full.

NOW, THEREFORE, if said Principal and all subcontractors to whom any portion of the work provided for in
said contract is sublet and all assignees of said Principal and of such subcontractors shall promptly make payment to
all persons supplying him or them with labor, foodstuffs, or supplies for or in the prosecution of the work provided for
in such contract, or in any amendment or extension of or addition to said contract, and for the payment of reasonable
attorney's fees, incurred by the claimant or claimants in suits on said bond, then the above obligation shall be void;
otherwise, it shall remain in full force and effect.

PROVIDED, however, that this bond is subject to the following conditions and limitations:

(a) Any person, firm or corporation that has furnished labor, foodstuffs, or supplies for or in the
prosecution of the work provided for in said contract, payment for which has not been made, shall have a direct right
of action in his or their name or names against the principal and surety on this bond, which right of action shall be
asserted in a proceeding, instituted in the county in which the work provided for in said contract is to be performed and
in any county in which said Principal or Surety does business. Such right of action shall be asserted in a proceeding
instituted in the name of the claimant or claimants for his or their use and benefit against said Principal and Surety or
either of them (but not later than one year after the final settlement of said Contract) in which action such claim or
claims shall be adjudicated and judgment rendered thereon.

(b) In addition to any other legal mode of service, service of summons and other process in suits on this
bond brought in Tuscaloosa County may be had on the Principal or the Surety in accordance with Title 27, Chapter 3,
Section 24 of the Ala. Code (1975) by serving a copy of the summons and complaint or other pleading or process,
with the Commissioner of Insurance of the State of Alabama or his/ her designee and the Principal and Surety agree
to be bound by such mode of service above described and consents that such service shall be the same as personal
service on the Principal or Surety.

(c) The Surety shall not be liable hereunder for any damages or compensation recoverable under any workmen's compensation or employer's liability statute.

(d) In no event shall the Surety be liable for a greater sum than the penalty of this bond, or subject to any suit, action or proceeding thereon that is instituted later than one year after the final settlement of said contract.

(e) This bond is given pursuant to the terms of Title 39, Chapter 1, Section 1 of the Ala. Code (1975), and all the provisions of law with reference to this character of bond as set forth in said section or as may hereinafter be enacted are hereby made a part hereof to the same extent as if set out herein in full.

IN WITNESS WHEREOF, the said Contractor has hereunder affixed its signature and said Surety has hereunto caused to be affixed its corporate signature and seal, by its duly authorized officers on the _____ day of _____, 20____.

Principal

By: _____

Title

Surety

ATTEST:

By: _____

Title

STATE OF ALABAMA)
TUSCALOOSA COUNTY)
CITY OF TUSCALOOSA)

CONTRACTOR'S RELEASE OF LIENS AND CLAIMS
Project No. A16-1320

THIS Contractor's Release of Liens and Claims is made in accordance with that certain contract between the CITY OF TUSCALOOSA, ALABAMA, a Municipal Corporation, (hereinafter the "City") and TURNER PLUMBING, INC. (hereinafter the "Contractor" or undersigned), for a project known as The Edge Business Resource Center – TP 8 - Plumbing in regard to which the undersigned warrants and certifies to the City as follows:

1. That there are no amounts owed by the undersigned or any tier of subcontractor or supplier of the undersigned which could become the basis for a lien or suit against the properties of the Contractor or the property of the City or any funds held by or in the possession of the City in regard to the Project.

2. That the undersigned has satisfied all claims and indebtedness of every nature in any way connected with the work, including (but not limited to) all payrolls, amounts due to subcontractors, accounts for labor performed and materials furnished, incidental services, liens and judgments.

3. In consideration of the receipt by the undersigned from the City of final payment under the above mentioned contract, the undersigned hereby waives and relinquishes all liens and claims of lien which the undersigned may have against the aforesaid property or funds; and further, undersigned also hereby remises, releases and forever discharges the City, its officers, agents and employees, of any and all claims, demands and causes of action whatsoever which the undersigned has, might have or could have against the City by reason of or arising out of the above-mentioned contract. The undersigned further agrees to indemnify and hold the City, its officers, agents and employees harmless against any and all claims or demands from subcontractors or suppliers arising out of the aforementioned contract.

IN WITNESS WHEREOF, the undersigned has duly executed this release this the _____ day of _____, 20_____.

CONTRACTOR: TURNER PLUMBING, INC.

BY: _____
TITLE: _____

I, _____, after being duly sworn, depose and say as follows: That I am the _____ of the _____ Corporation and hereby certify that I am duly authorized to execute this Contractor's Release of Liens and Claims.

STATE OF ALABAMA)
TUSCALOOSA COUNTY)
Sworn to and subscribed before me on this
the _____ day of _____, 20_____.

Notary Public

CONSENT OF SURETY:

SURETY
BY: _____
ATTORNEY-IN-FACT FOR SURETY

CITY OF TUSCALOOSA PUBLIC WORKS
ROOFING GUARANTEE
Project No. _____

Name of Project _____

Location _____

Owner _____ City of Tuscaloosa

General Contractor _____

Address _____

Date of Acceptance _____ Date of Expiration _____

1. The General Contractor does hereby certify to the City of Tuscaloosa that the roofing work included in this contract was installed in strict accordance with all requirements of the plans and specifications.

2. The General Contractor does hereby guarantee the roofing and associated work including all flashing, both composition and metal, against leaks due to faulty workmanship for a period of five (5) years and against leaks due to faulty or defective materials for twenty (20) years, starting on the date of acceptance of the Project by the City.

3. Subject to the terms and conditions listed below, the General Contractor guarantees that during the Guarantee Period he will at his own cost and expense, make or cause to be made such repairs to, or replacements of said work, as are necessary to correct faulty and defective work and materials as are necessary to maintain said work in watertight conditions, and further, to respond on or within three (3) calendar days upon proper notification of leaks or defects by the City or Architect.

A. Specifically excluded from this Guarantee are damages to the work, other parts of the building and building contents caused by: Lightning, windstorm, hail storm and other unusual phenomena of elements; and, Fire. When the work has been damaged by any of the foregoing causes, the Guarantee shall be null and void until such damage has been repaired by the General Contractor, and until the cost and expense thereof has been paid by the City or by the responsible party so designated.

B. During the Guarantee Period, if the City allows alteration of the work by anyone other than the General Contractor, including cutting, patching and maintenance in connection with penetrations, and positioning of anything on the roof, this Guarantee shall become null and void upon the date of said alterations. If the City engages the General Contractor to perform said alterations, the Guarantee shall not become null and void, unless the General Contractor, prior to proceeding with said work, shall have notified the City in writing, showing reasonable cause for claim that said alterations would likely damage or deteriorate the work, thereby reasonably justifying a termination of this Guarantee.

C. Future building additions will not void this guarantee, except for that portion of the future addition that might affect the work under this contract at the point of connection of the roof areas, and any damage caused by such addition. If this contract is for roofing of an addition to an existing building, then this guarantee covers the work involved at the point of connection with the existing roof.

D. During the Guarantee Period, if the original use of the roof is changed and it becomes used for, but was not originally specified for, a promenade, work deck, spray cooled surface, flooded basin, or other use of service more severe than originally specified, this Guarantee shall become null and void upon the date of said change.

E. The City shall promptly notify the General Contractor of observed, known or suspected leaks, defects or deterioration, and shall afford reasonable opportunity for the General Contractor to inspect the work, and to examine the evidence of such leaks, defects or deterioration.

IN WITNESS THEREOF, this instrument has been duly executed this the ___ day of _____, 20__.

General Contractor's Authorized Signature
NAME AND TITLE _____

CITY OF TUSCALOOSA
ASBESTOS AFFIDAVIT
Project No. _____

DATE: _____

BUILDING OWNER: _____

PROJECT: _____

TO WHOM IT MAY CONCERN:

The undersigned certifies that to the best of his knowledge, no products containing asbestos have been included in the construction of the captioned Project. Special care was exercised to avoid asbestos-containing products, including reviewing product data sheets, reviewing product labels, and visually verifying products in the field. Special care to avoid asbestos has been used in the selection, purchase, and installation of products, including, but not limited to, the following: concrete, batt insulation, roof insulation, building felts, mastics, waterproofing products, adhesives, resilient flooring products, ceiling tiles, interior coatings, exterior coatings, roofing, pipe insulation, duct insulation, and pre-assembled items of equipment.

Respectfully submitted,

Signature

Typed Name

Title

Firm Name

Address

Sworn to and subscribed before me on this the _____
day of _____, 20_____.

Notary Public.

County, State

My Commission Expires:



CERTIFICATE OF LIABILITY INSURANCE

DATE (MM/DD/YYYY)
7/7/2017

THIS CERTIFICATE IS ISSUED AS A MATTER OF INFORMATION ONLY AND CONFERS NO RIGHTS UPON THE CERTIFICATE HOLDER. THIS CERTIFICATE DOES NOT AFFIRMATIVELY OR NEGATIVELY AMEND, EXTEND OR ALTER THE COVERAGE AFFORDED BY THE POLICIES BELOW. THIS CERTIFICATE OF INSURANCE DOES NOT CONSTITUTE A CONTRACT BETWEEN THE ISSUING INSURER(S), AUTHORIZED REPRESENTATIVE OR PRODUCER, AND THE CERTIFICATE HOLDER.

IMPORTANT: If the certificate holder is an ADDITIONAL INSURED, the policy(ies) must be endorsed. If SUBROGATION IS WAIVED, subject to the terms and conditions of the policy, certain policies may require an endorsement. A statement on this certificate does not confer rights to the certificate holder in lieu of such endorsement(s).

PRODUCER Fitts Agency Inc. 1806 6th Street Tuscaloosa, AL 35401	CONTACT NAME: Tiffany Jackson, CISR
	PHONE (A/C, No, Ext): (205) 342-3556 FAX (A/C, No): (205) 342-3467
	E-MAIL ADDRESS: tjackson@fittsagency.com
	INSURER(S) AFFORDING COVERAGE
	INSURER A : Frankenmuth Mutual NAIC # 13986
	INSURER B : Benchmark Ins Companies NAIC # 41394
	INSURER C :
	INSURER D :
	INSURER E :
	INSURER F :

INSURED Turner Plumbing, Inc. P.O.Box 71531 Tuscaloosa, AL 35407	INSURER A : Frankenmuth Mutual	NAIC # 13986
	INSURER B : Benchmark Ins Companies	NAIC # 41394
	INSURER C :	
	INSURER D :	
	INSURER E :	
	INSURER F :	

COVERAGES CERTIFICATE NUMBER: REVISION NUMBER:

THIS IS TO CERTIFY THAT THE POLICIES OF INSURANCE LISTED BELOW HAVE BEEN ISSUED TO THE INSURED NAMED ABOVE FOR THE POLICY PERIOD INDICATED. NOTWITHSTANDING ANY REQUIREMENT, TERM OR CONDITION OF ANY CONTRACT OR OTHER DOCUMENT WITH RESPECT TO WHICH THIS CERTIFICATE MAY BE ISSUED OR MAY PERTAIN, THE INSURANCE AFFORDED BY THE POLICIES DESCRIBED HEREIN IS SUBJECT TO ALL THE TERMS, EXCLUSIONS AND CONDITIONS OF SUCH POLICIES. LIMITS SHOWN MAY HAVE BEEN REDUCED BY PAID CLAIMS.

INSR LTR	TYPE OF INSURANCE	ADDL INSD	SUBR WVD	POLICY NUMBER	POLICY EFF (MM/DD/YYYY)	POLICY EXP (MM/DD/YYYY)	LIMITS
A	<input checked="" type="checkbox"/> COMMERCIAL GENERAL LIABILITY <input type="checkbox"/> CLAIMS-MADE <input checked="" type="checkbox"/> OCCUR	X	X	BOP6123438	10/06/2016	10/06/2017	EACH OCCURRENCE \$ 1,000,000 DAMAGE TO RENTED PREMISES (Ea occurrence) \$ 500,000 MED EXP (Any one person) \$ 5,000 PERSONAL & ADV INJURY \$ 1,000,000 GENERAL AGGREGATE \$ 2,000,000 PRODUCTS - COMP/OP AGG \$ 2,000,000
	GEN'L AGGREGATE LIMIT APPLIES PER: <input type="checkbox"/> POLICY <input checked="" type="checkbox"/> PROJECT <input type="checkbox"/> LOC OTHER:						
A	AUTOMOBILE LIABILITY <input checked="" type="checkbox"/> ANY AUTO <input type="checkbox"/> ALL OWNED AUTOS <input checked="" type="checkbox"/> HIRED AUTOS <input type="checkbox"/> SCHEDULED AUTOS <input checked="" type="checkbox"/> NON-OWNED AUTOS	X	X	BA 6123438	10/06/2016	10/06/2017	COMBINED SINGLE LIMIT (Ea accident) \$ 1,000,000 BODILY INJURY (Per person) \$ BODILY INJURY (Per accident) \$ PROPERTY DAMAGE (Per accident) \$
A	<input checked="" type="checkbox"/> UMBRELLA LIAB <input checked="" type="checkbox"/> OCCUR <input type="checkbox"/> EXCESS LIAB <input type="checkbox"/> CLAIMS-MADE	X	X	BOP6123438	10/06/2016	10/06/2017	EACH OCCURRENCE \$ 5,000,000 AGGREGATE \$ 5,000,000 DED <input checked="" type="checkbox"/> RETENTION \$ 10,000
B	WORKERS COMPENSATION AND EMPLOYERS' LIABILITY ANY PROPRIETOR/PARTNER/EXECUTIVE OFFICER/MEMBER EXCLUDED? (Mandatory in NH) if yes, describe under DESCRIPTION OF OPERATIONS below	Y/N N	N/A	WC044-0035704-2016A	10/06/2016	10/06/2017	<input checked="" type="checkbox"/> PER STATUTE <input type="checkbox"/> OTH-ER E.L. EACH ACCIDENT \$ 1,000,000 E.L. DISEASE - EA EMPLOYEE \$ 1,000,000 E.L. DISEASE - POLICY LIMIT \$ 1,000,000
A	Installation Floater			BOP6123438	10/06/2016	10/06/2017	Limit 200,000
A	Leased/Rented Eqpmt			BOP6123438	10/06/2016	10/06/2017	Limit 50,000

DESCRIPTION OF OPERATIONS / LOCATIONS / VEHICLES (ACORD 101, Additional Remarks Schedule, may be attached if more space is required)
Project: The Edge
JT Harrison Construction Co., Inc. and The City of Tuscaloosa are additional insureds with respect to General Liability and Auto Liability when required by written contract. Umbrella Liability Follows Form. General Liability applies on a primary and non-contributory basis. Waiver of Subrogation applies in favor of JT Harrison Construction Co., Inc. and The City of Tuscaloosa with respect to General Liability, Auto Liability and Workers Compensation when required by written contract. Umbrella Liability Follows Form.
30 Day Notice of Cancellation applies except for nonpayment of premium, then only 10 days notice shall be given.

CERTIFICATE HOLDER City of Tuscaloosa PO Box 2089 Tuscaloosa, AL 35401	CANCELLATION SHOULD ANY OF THE ABOVE DESCRIBED POLICIES BE CANCELLED BEFORE THE EXPIRATION DATE THEREOF, NOTICE WILL BE DELIVERED IN ACCORDANCE WITH THE POLICY PROVISIONS.
	AUTHORIZED REPRESENTATIVE

PROJECT NAME The Edge Business Resource
Center - TP 8 - Plumbing
PROJECT NO. A16-1320
CONTRACTOR/INSURED _____
Turner Plumbing, Inc.

STATE OF ALABAMA)
)
TUSCALOOSA COUNTY)

AGENT'S VERIFICATION OF CONTRACTOR'S INSURANCE

This is to certify to the City of Tuscaloosa, Alabama, a Municipal Corporation, that the Contractor in the above referenced Project does possess a policy or policies of insurance reflected on the Certificate of Insurance issued for the Project by the undersigned agency of which I am an authorized representative. I have read the contract document as it relates to insurance requirements and said Contractor's insurance is effective as of the dates stated in the certificate and meets or exceeds all ratings, limits, and amounts as required by the same.

This the _____ day of _____, 20_____.

AGENCY: _____

BY: _____
ITS: _____

STATE OF ALABAMA)
TUSCALOOSA COUNTY)

NOTICE OF CONDITIONAL BID AWARD
CITY OF TUSCALOOSA, ALABAMA

VIA FACSIMILE: _____
TO: Turner Plumbing, Inc.
1700 26th Avenue
Tuscaloosa, Alabama 35401

The Edge Business Resource
Project Name: Center – TP 8 - Plumbing
Project Number: A16-1320
Date: _____

You are here notified pursuant to Ala. Code §39-2-6 (1975), that the City of Tuscaloosa has made a conditional bid award to you in regard to the above-referenced Project based upon your proposal of \$ 178,500.00

The above bid award Does Does Not include the following additive and/or deductive alternates as requested in the bid documents:

Additive Alternates	Deductive Alternates
1. _____ (\$ _____)	1. _____ (\$ _____)
2. _____ (\$ _____)	2. _____ (\$ _____)
3. _____ (\$ _____)	3. _____ (\$ _____)

Pursuant to Ala. Code §39-2-8 (1975), you are required to enter into a written contract on the form included in the proposal, plans and specifications, furnish a performance bond and a payment bond executed by a surety company authorized and qualified to make such bonds in the State of Alabama, in the amount required in the bid documents, and present evidence of insurance also as required by the bid documents, within the period of time stated therein or, if no period of time is stated, within thirty (30) days after the prescribed forms have been presented to you for signature.

Pursuant to Ala. Code §39-2-11 (1975), if you fail to execute the contract and furnish acceptable contract securities and evidence of insurance as required by the bid documents within the period of time as set forth, the awarding authority may retain all or a part of the proposal guarantee and may award the contract to the second lowest responsible responsive bidder. Under such circumstances, the owner will be entitled to consider all rights arising out of its acceptance of your proposal as abandoned.

DONE this _____ day of _____, 20_____.

CITY OF TUSCALOOSA, ALABAMA
A MUNICIPAL CORPORATION
Post Office Box 2089
Tuscaloosa, Alabama 35403-2089

By: _____
City's Representative/Engineer/Architect

ACCEPTANCE OF NOTICE

I, on behalf of the above named contractor, do hereby accept receipt of the above notice of conditional bid award and acknowledge the contents of the same on this the _____ day of _____ 20_____.

CONTRACTOR: TURNER PLUMBING, INC.

By its: _____

STATE OF ALABAMA)
TUSCALOOSA COUNTY)
CITY OF TUSCALOOSA)

NOTICE TO PROCEED WITH PUBLIC WORKS PROJECT
CITY OF TUSCALOOSA, ALABAMA

Project Name: The Edge Business Resource Center - TP 8 - Plumbing
Project No.: A16-1320
Date: 8-10-17

TO: Turner Plumbing Inc.
1700 26th Avenue
Tuscaloosa, Alabama 35401

Pursuant to Ala. Code §39-2-10 (1975), you are hereby notified to immediately commence work in full accordance with the terms and conditions of the Contract Documents in the above referenced Project, dated June 21st, 20 17, on or before August 10th, 20 17, and you are to complete the work within the time specified therein.

CITY OF TUSCALOOSA, ALABAMA
A MUNICIPAL CORPORATION
Post Office Box 2089
Tuscaloosa, Alabama 35403-2089

By: 
City's Representative

ACCEPTANCE OF NOTICE

I, on behalf of the above named contractor, do hereby accept receipt of the above notice to proceed with the referenced Project and acknowledge the contents of the same on this the 21st day of August, 20 17.

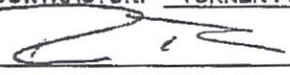
CONTRACTOR: TURNER PLUMBING, INC.

By Its: President

CONTRACT CHANGE ORDER NO.

City of Tuscaloosa, Office of the City Attorney

DATE: _____ **PROJECT:** The Edge Business Resource Center-TP 8-Plumbing

TO: Turner Plumbing, Inc. (A16-1320)
(Contractor)

TERMS: You are hereby authorized, subject to the provisions of your Contract for this Project, to make the following changes thereto in accordance with the attached Change Order Request and supporting documents and to:

FURNISH the necessary labor, materials and equipment to:

TOTAL ADDITION OR REDUCTION TO CONTRACT PRICE:

(Note: Numbers in parentheses are deductions).

ORIGINAL CONTRACT PRICE	\$	_____
LESS CONTINGENCY/ALLOWANCE	\$	_____
NET ORIGINAL CONTRACT PRICE	\$	_____
Net total of previous Change Orders	\$	_____
Previous revised Contract Price	\$	_____
This Change Order No. _____ <input type="checkbox"/> Add <input type="checkbox"/> Deduct	\$	_____
Revised Contract Price this date	\$	_____

Extension of time resulting from this Change Order _____ (Indicate number of calendar days).

The amount of this Change Order will be the responsibility of _____

This Contract Modification constitutes full and mutual accord and satisfaction for all time and all cost related to this change. By acceptance of this Contract Modification, the Contractor hereby agrees that the modification represents an equitable adjustment to the Contract, and further, agrees to waive all right to file any further claims or changes arising out of or as a result of this change, or the accumulation of executed Contract Modifications on this Contract.

The Contractor and Owner(s) hereby agree to the terms of this Change Order as contained herein.

CONSENT OF SURETY

CONTRACTING PARTIES

(Company)

TURNER PLUMBING, INC.
(Contractor)

By: _____

By: _____
(Authorized Representative)

RECOMMENDED

CITY OF TUSCALOOSA

By: _____

(Design Engineer or Architect)

By: _____
(Mayor)

CITY OF TUSCALOOSA
OFFICE OF THE CITY ATTORNEY

**CHANGE
ORDER
REQUEST**

OWNER: CITY OF TUSCALOOSA

ARCHITECT/ENGINEER: Ward Scott Architecture

CONTRACTOR: Turner Plumbing, Inc. (A16-1320)

PROJECT: The Edge Business Resource Center – TP 8 - Plumbing

CHANGE ORDER REQUEST NO. _____ DATE: _____

1. DESCRIPTION OF CHANGE:

2. CHANGE ORDER COSTS: _____

Proposal Attached _____ Cost Estimated/Proposal Required

<i>Item</i>	<i>Quantity</i>	<i>Material Unit Price</i>	<i>Labor (Hours)</i>	<i>Labor Unit Price</i>	<i>Sub-Total Cost</i>
a.					
b.					
c.					
d.					
e.					
f.*					
TOTAL:					

*If more than 6 items, provide attachments.

3. INSTITUTED BY:

4. JUSTIFICATION OF NEED:

5. JUSTIFICATION OF CHANGE ORDER VERSUS COMPETITIVE BIDDING:

6. COSTS REVIEW:

7. THIS CHANGE ORDER IS SUBMITTED FOR REVIEW AND APPROVAL AND IS CLASSIFIED AS THE FOLLOWING TYPE:

- Minor change of a total monetary value less than required for competitive bidding.
 - Changes for matters relatively minor and incidental to the original contract necessitated by unforeseeable circumstances arising during the course of work.
 - Emergencies arising during the course of work.
 - Change or alternates provided for in the original bidding where there is no difference in price of the Change Order from the original best bid on the Alternate.
 - Change of relatively minor terms not contemplated when the plans and specifications were prepared and the Project was bid and which are in the public interest and do not exceed 10% of the Contract Price.
-

8. EXTENSION OF TIME REQUESTED: Calendar Days:

RECOMMENDED:

APPROVED:

BY: _____
Tuscaloosa's Consulting Engineer/Architect

BY: _____
Contractor

BY: _____
City Representative

BY: _____
Owner's Legal Advisor

BY: _____
Owner's Authorized Representative

STATE OF ALABAMA)
COUNTY OF TUSCALOOSA)
CITY OF TUSCALOOSA)

**LEGAL NOTICE
NOTICE OF COMPLETION OF PUBLIC WORKS PROJECT
(Over \$50,000)**

Pursuant to Ala. Code §39-1-1 (1975), notice is hereby given that
Turner Plumbing, Inc. has completed its contract with
(Name of Company)
the City of Tuscaloosa, Alabama, for the The Edge Business Resource Center – TP 8 - Plumbing
(Name of Project)
located at _____ . This notice will be
(Location of the Project)
published for a period of four (4) successive weeks beginning: _____
(Date)

A final settlement will not be made upon the contract until the expiration of thirty (30) days after completion of notice. Any person or firm having claims on said Project for materials or labor should contact the above contractor at:

1700 26th Avenue, Tuscaloosa, Alabama 35401
(Address of Contractor)

in the time and manner as required by law.

**CITY OF TUSCALOOSA
OFFICE OF THE CITY ATTORNEY
P. O. BOX 2089
TUSCALOOSA, ALABAMA 35403**

DATED: _____

**CITY OF TUSCALOOSA
SPECIAL CONDITIONS FOR
FEDERALLY FUNDED CONTRACTS**

I. DEFINITIONS

"Construction Contract" means a contract for construction, rehabilitation, alteration, and/or repair, including painting and decorating.

Contractor means an entity that has entered into an agreement with the local government for the performance of specific work on a project or activity, the provision of professional services, or for the supply of equipment and/or materials.

" _____ " means _____ (Federal Agency).

"Local Government" means the City of Tuscaloosa.

"Program" means the _____
(Federal Program) operated under the provisions of _____

"Projects/Activities" means those undertakings which are included in the Program and are funded wholly or in part by _____

"Project Area" means the corporate limits of the City of Tuscaloosa.

"Subcontractor" means a person, firm or corporation supplying services or labor and materials or only labor or only materials for work at the site of the project, for and under contract or agreement with the Contractor.

II. CONFLICT OF INTEREST

A. Interest of Members of the Local Government. No officer, employee or agent of the local government who exercises any function or responsibilities in connection with the planning and carrying out of the program, or any other person who exercises any functions or responsibilities in connection with the program, shall have any personal financial interest, direct or indirect, in this contract, and the Contractor shall take appropriate steps to assure compliance.

B. The Contractor agrees that it will incorporate into every subcontract required in writing the following provision: Interest of Contractor and Employees. The Contractor agrees that no person who presently exercises any functions or responsibilities in connection with the program, has any personal financial interest, direct or indirect, in this contract. The Contractor further covenants that he presently has no interest and shall not acquire any interest, direct or indirect, which would conflict in any manner or degree with the performance of his services hereunder.

The Contractor further covenants that in the performance of this contract no person having any conflicting interest shall be employed. Any interest on the part of the Contractor or his employees must be disclosed to the City. Provided, however, that this paragraph shall be interpreted in such a manner so as not to unreasonably impede the statutory requirement that maximum opportunity be provided for employment of and participation by low income residents of the area.

C. Provisions of the Hatch Act. Neither the funds provided by this agreement nor the personnel employed in the administration of the agreed upon work shall be in any way or to any extent engaged in the conduct of political activities in contravention of Chapter 15 of Title 5, U. S. Code.

III. **EQUAL OPPORTUNITY REQUIREMENTS:** During the performance of this contract, the Contractor agrees as follows:

A. The Contractor will not discriminate against any employee or applicant for employment because of race, color, religion, sex, national origin, age, or disability. The Contractor will take affirmative action to ensure that applicants are employed, and that employees are treated during employment without regard to their race, color, religion, sex, national origin, age, or disability. Such action shall include, but not be limited to the following: employment, upgrading, demotion, or transfer; recruitment, or recruitment advertising; layoff or termination; rates of pay or other forms of compensations; and selection of training, including apprenticeship. The Contractor agrees to post in conspicuous places, available to employees and applicants for employment, notices setting forth the provisions of this non-discrimination clause.

B. The Contractor will, in all solicitations or advertisements for employees placed by or on behalf of the Contractor, state that all qualified applicants will receive consideration for employment without regard to race, color, religion, sex, national origin, age, or disability.

C. The Contractor will send to each labor union or representative of workers with which he has collective bargaining agreement or other contract or understanding, a notice advising the said labor union or workers' representatives of the Contractor's commitments under this section, and shall post copies of the notice in conspicuous places available to employees and applicants for employment.

D. The Contractor will comply with all provisions of Executive Order 11246 of September 24, 1965, and of the rules, regulations, and relevant orders of the Secretary of Labor.

E. The Contractor will furnish to the local government all information and reports required by Executive Order 11246 of September 24, 1965, and by rules, regulations, and orders of the Secretary of Labor, or pursuant thereto, and will permit access to his books, records, and accounts by the local government, HUD, and the Secretary of Labor for purposes of investigation to ascertain compliance with such rules regulations, and orders.

F. In the event of the Contractor's non-compliance with the nondiscrimination clauses of this agreement or with any of the said rules, regulations, or orders, this agreement may be canceled, terminated, or suspended in whole or in part and the Contractor may be declared ineligible for further local government contracts in accordance with procedures authorized in Executive Order 11246 of September 24 1965, and such other sanctions may be imposed and remedies invoked as provided in Executive Order 11246 of September 24, 1965, or by rule, regulation, or order of the City, Secretary of Labor, or as otherwise provided by law.

G. The Contractor will include the provisions of paragraph 1 through 6 above in every subcontract or purchase order unless exempted by rules, regulations, or orders of the local government or the Secretary of Labor issued pursuant to Section 204 of Executive Order 11246 of September 24, 1965, so that such provisions will be binding upon each subcontractor or vendor. The Contractor will take such action with respect to any subcontract or purchase order as may be directed as a means of enforcing such provisions, including sanctions for noncompliance: Provided however, that in the event a Contractor becomes involved in, or is threatened with, litigation with a subcontractor or vendor as a result of such direction by the City, the Contractor may request the local government to enter into such litigation to protect the interests of the local government.

H. The Contractor agrees that it will assist and cooperate actively with the local government and the Secretary of Labor in obtaining the compliance of subcontractors with the equal opportunity clause and the rules, regulations, and relevant orders of the Secretary of Labor, that it will furnish the local government and the Secretary of Labor such information as they may require for the supervision of such compliance, and that it will otherwise assist the local government in the discharge of its primary responsibility for securing compliance.

I. The Contractor further agrees that it will refrain from entering into any contract or contract modification subject to Executive Order 11246 of September 24, 1965, with a Contractor debarred from, or who has

not demonstrated eligibility for, Government contracts and federally assisted construction contracts pursuant to the Executive Order. In addition, the agency agrees that if it fails or refuses to comply with these undertakings, the local government may take any or all of the following actions: terminate or suspend in whole or in part this contract; refrain from extending any further assistance to the Contractor under the program with respect to which the failure or refusal occurred until satisfactory assurance of future compliance has been received from such Contractor.

J. **Non-segregated Facilities.** The Contractor certifies that he does not maintain or provide for his employees any segregated facilities at any of his establishments and that he does not permit his employees to perform their services at any location, under his control, where segregated facilities are maintained. The Contractor covenants that he will not maintain or provide for his employees any segregated facilities at any of his establishments, and that he will not permit his employees to perform their services at any location, under his control, where segregated facilities are maintained. As used in this paragraph, the term "segregated facilities" means any waiting rooms, work areas, restrooms and washrooms, restaurants and other eating areas, time clocks, locker rooms and other storage or dressing areas, parking lots, drinking fountains, recreation or entertainment areas, transportation, and housing facilities provided for employees which are segregated on the basis of race, creed, color, or national origin, because of habit, local custom, or otherwise.

K. No person in the United States shall, on the ground of race, color, religion, sex, or national origin, be excluded from participation in, be denied the benefits of, or be subject to discrimination under any program or activity made possible by or resulting from this contract. The agency and each employer will comply with all requirements imposed by or pursuant to Title VI of the Civil Rights Act of 1964.

L. The Contractor shall maintain data which records its affirmation action in equal opportunity employment, including but not limited to employment, upgrading, demotions, transfers, recruitment or recruitment advertising, layoffs or terminations, pay or other compensation, and selection for training.

IV. LABOR STANDARDS PROVISIONS - CONSTRUCTION CONTRACTS ONLY

A. Contract Work Hours and Safety Standards Act

1. **Overtime Requirements.** No Contractor or subcontractor contracting for any part of the contract work which may require or involve the employment of laborers or mechanics shall require or permit any laborer or mechanic in any work-week in which he is employed on such work to work in excess of forty hours in any work-week unless such laborer or mechanic receives compensation at a rate not less than one and one-half times his basic rate of pay for all hours worked in excess of forty hours in any work-week.
2. **Violations; Liability for Unpaid Wages; Liquidated Damages.** In the event of any violation of the clause set forth in subparagraph 1, the Contractor and any subcontractor responsible therefore shall be liable to any affected employee for his unpaid wages. In addition, such Contractor and subcontractor shall be liable to the City for liquidated damages. Such liquidated damages shall be computed with respect to each individual laborer or mechanic employed in violation of the clause set forth in subparagraph 1 in the sum of \$10 for each calendar day on which such employee was required or permitted to work in excess of the standard work-week of forty hours without payment of the overtime wages required by the clause set forth in subparagraph 1.
3. **Withholding for Unpaid Wages and Liquidated Damages.** The local government may withhold or cause to be withheld, from any monies payable on account of work performed by the Contractor or subcontractor, such sums as may administratively be determined to be necessary to satisfy any liabilities of such Contractor or subcontractor for unpaid wages and liquidated damages.

B. Employment of Certain Persons Prohibited. No person under the age of sixteen years and no person who at the time, is serving sentence in a penal or correctional institution shall be employed on the work covered by this contract.

C. Complaints, Proceedings, or Testimony by Employees. No laborer or mechanic to whom the labor standards provisions of this contract are applicable shall be discharged or in any other manner discriminated against by the Contractor or any subcontractor because such employee has filed any complaint or instituted or caused to be instituted any proceedings or has testified or is about to testify in any proceedings under or relating to the labor standards applicable under this contract.

D. Questions Concerning Certain Federal Statutes and Regulations. All questions arising under this contract which relate to the application or interpretation of the aforesaid Contract Work Hours and Safety Standards Act, the regulations issued by the Secretary of Labor, United States Department of Labor, pursuant to said Act, or the labor standards provisions of any other pertinent Federal statute, shall be referred, through the City of Tuscaloosa and the Secretary of Housing and Urban Development, to the Secretary of Labor, United States Department of Labor, for said Secretary's appropriate ruling or interpretation which shall be authoritative and may be relied upon for the purpose of this contract.

V. ENVIRONMENTAL PROTECTION REQUIREMENTS

A. The Contractor hereby agrees that any facility to be utilized in the performance of any nonexempt contract or subcontract shall not be a facility included on the list of Violating Facilities issued by the Environmental Protection Agency (EPA) pursuant to 40 CFR 15.20.

B. The Contractor also agrees to comply with all the requirements of Section 114 of the Clean Air Act, as amended, (42 USC 1857c-8) and Section 308 of the Federal Water Pollution Control Act, as amended, (33 USC 1318) relating to inspection, monitoring, entry, reports and information, as well as all other requirements specified in said Section 114 and Section 308, and all regulations and guidelines issued thereunder.

C. As a condition of the award of the contract, the Contractor agrees to give prompt notice to the City of any notification received from the Director, Office of Federal Activities, EPA, indicating that a facility utilized or to be utilized for the contract is under consideration to be listed on the EPA List of Violating Facilities.

D. The Contractor agrees that it will include or cause to be included the criteria and requirements in subparagraph A through D of this section in every nonexempt subcontract and that it will take such action as the City or the EPS may direct as a means of enforcing such provisions.

VI. FINANCIAL MANAGEMENT: The Contractor shall maintain effective control over and accountability for all funds, property, and other assets that are provided for by this agreement. The Contractor shall adequately safeguard all such assets and shall assure that they are used solely for authorized purposes.

A. Ineligible Costs. In addition to any costs that are ineligible under other criteria included herein the following costs are specifically ineligible:

1. Bad Debts. Any losses arising from uncollected accounts and other claims, and related costs.
2. Contingencies. Contributions to a contingency reserve or any similar provisions for unforeseen events.
3. Contributions and Donations.
4. Entertainment. Costs of amusements, social activities, and incidental costs, such as meals, beverages, lodgings, and gratuities, relating to entertainment.
5. Fines and Penalties. Costs resulting from violations of or failure to comply with Federal, State, and local laws and regulations.
6. Interest and Other Financial Costs. Interest on borrowing (however represented), bond

discounts, cost of financing and refinancing operations, and legal and professional fees paid in connection herewith.

7. **Legislative Expenses.** Salaries and other expenses of local government bodies such as county supervisors, city councils, school boards, etc., whether incurred for purposes of legislation or executive direction.
8. **Membership Expenses.** Cost of membership in an organization which devotes a substantial part of its activities to influencing legislation.
9. **Travel.** Costs in excess of those allowed by the Contractor for its equivalent employees. In any case, the difference in cost between first-class air accommodations and less-than-first-class air accommodations are not available and is so documented.
10. **Meeting Attendance.** Costs of attending meetings which are not open for attendance on a non-segregated basis.

B. **Property Management Standards.** The Contractor's property management standards for non-expendable personal property acquired under this contract shall include the following procedural requirements:

1. Property records shall be maintained accurately and provide for: a description of the property; manufacturer's serial number or other identification number; acquisition data, cost, and source of property; percentage of Federal funds used in the purchase of property; location, use and condition of the property; and ultimate disposition data including sales price or the method used to determine current fair market value.
2. A physical inventory of property shall be taken and the results reconciled with the property records at least once each year to verify the existence, current utilization, and continued need for the property.
3. A control system shall be in effect to ensure adequate safeguards to prevent loss, damage, or theft to the property. Any loss, damage, or theft of non-expendable property shall be investigated and fully documented.
4. Adequate maintenance procedures shall be implemented to keep the property in good condition.

C. **Procurement Standards**

1. The Contractor shall maintain a code or standard of conduct which shall govern the performance of its officers, employees, or agents in contracting with and expending grant funds. Local government officers, employees, or agents shall neither solicit nor accept gratuities, favors, or anything of monetary value from Contractors or potential Contractors.
2. All procurement transactions regardless of whether negotiated or advertised and without regard to dollar value shall be conducted in a manner so as to provide maximum open and free competition.

VII. **GENERAL REQUIREMENTS**

A. **Retention of Records.** All records maintained by the Contractor that pertain to this agreement shall be retained by the Contractor for a period of three years or such longer period as the local government or HUD may require in specific cases.

B. **Reports and Information.** The Contractor, at such times as the local government may require, shall furnish such statements, reports, records, data and information, as may be requested pertaining to matters covered by this agreement.

C. **Audit Requirements.** The local government, the Comptroller General of the United States, and/or __

_____ (Federal Agency), or any of the duly authorized representatives shall have access to all tasks, accounts, records, reports, files and other papers or property of the Contractor pertaining to funds provided under this agreement for the purpose of making surveys, audits, examinations, excerpts, and transcripts. The Contractor's financial management system shall be audited at least once a year. Audits may be made at less frequency considering the nature, size and complexity of the activity. The Contractor shall implement a systematic method to assure timely and appropriate resolution of audit findings and recommendations.

D. Breach of Contract Terms and Conditions. In the event of the Contractor's noncompliance with the terms and conditions of this contract or with any of the said rules, regulations or orders, this contract may be canceled, terminated or suspended in whole or in part. Provided, that the right of the Contractor to proceed with this contract shall not be terminated or the Contractor charged with liquidated damages because of delays in the completion of the work due to unforeseeable causes beyond the control and without the fault or negligence of the Contractor, including but not restricted, to acts of God, or of the public enemy, acts of the Government, fires, floods, epidemics, quarantine restrictions, strikes, freight embargoes, and unusually severe weather or delays of subcontractors due to such causes, if the Contractor shall within ten days from the beginning of any such delay notify the City in writing of the cause of the delay. The City shall ascertain the facts and the extent of the delay and extend the time for completing the work when, in the City's judgment, the findings of fact justify such an extension, and the City's findings of fact thereon shall be final and conclusive on the parties hereto, subject only to appeal, within thirty days, by the Contractor to the City whose decision on such appeal as to the facts of delay and the extension of time for completing the work shall be final and conclusive on the parties hereto.

E. Safety Standards. No Contractor or subcontractor contracting for any part of a construction contract shall require any laborer or mechanic employed in the performance of the contract to work in surroundings or under working conditions which are unsanitary, hazardous, or dangerous to his health or safety, as determined under construction safety and health standards promulgated by the Secretary of Labor.

F. Lead-based Paint Regulations. The construction or rehabilitation of residential structures with assistance provided under this contract is subject to the HUD Lead-based Paint regulations, 24 CFR part 35. Should this contract include activities involving the construction or rehabilitation of residential structures, the Contractor hereby agrees to comply with the regulations of 24 CFR part 35.

G. Subcontracts. The Contractor shall insert in any subcontracts all of the terms and conditions set forth in this contract and also a clause requiring the subcontractors to include these terms and conditions in any lower tier subcontracts which they may enter into, together with a clause requiring this insertion in any further subcontracts that may in turn be made.

H. Davis-Bacon. As applicable, Contractors shall comply with the Davis-Bacon Act (40 U.S.C. 276a to 276a-7) as supplemented by Department of Labor regulations (29 CFR Part 5), the provisions of which are incorporated by reference into this contract as if contained herein.

I. Debarment of contactors/subcontractors / City's right to monitor. All contracting and subcontracting agencies shall be actively registered in the sam.gov system and have a non-debarred status to perform work. The City of Tuscaloosa shall have all rights to any and all documentation related to the project. Periodic monitoring visits will be performed by City of Tuscaloosa staff to ensure all federal and contract requirements are followed.

J. Green Building Standard for Replacement and New Construction of Residential Housing. Contractors must meet the Green Building Standard in this subparagraph for: (i) all new construction of residential buildings; and (ii) all replacement of substantially-damaged residential buildings. Replacement of residential buildings may include reconstruction (i.e., demolishing and re-building a housing unit on the same lot in substantially the same manner) and may include changes to structural elements such as flooring systems, columns or load bearing interior or exterior walls. For purposes of this Notice, the Green Building Standard means the contractor will require that all construction covered by subparagraph, above, meet an industry-recognized standard that has achieved certification under at least one of the following programs (i) ENERGY STAR (Certified Homes or Multifamily High Rise); (ii)

Enterprise Green Communities; (iii) LEED (NC, Homes, Midrise, Existing Buildings O&M, or Neighborhood Development); (iv) ICC-700 National Green Building Standard; (v) EPA Indoor AirPlus (ENERGY STAR a prerequisite); or (vi) any other equivalent comprehensive green building program, including regional programs. Standards for rehabilitation of non-substantially-damaged residential buildings: For rehabilitation other than that described in subparagraph, above, contractors must follow the guidelines specified in the HUD CPD Green Building Retrofit Checklist, available on the CPD Disaster Recovery Web site. Contractors must apply these guidelines to the extent applicable to the rehabilitation work undertaken, including the use of mold resistant products when replacing surfaces such as drywall. When older or obsolete products are replaced as part of the rehabilitation work, rehabilitation is required to use ENERGY STAR- labeled, WaterSense labeled, or federal Energy Management Program (FEMP)-designated products and appliances. Implementation: For construction projects completed under construction, or under contract prior to the date that federal assistance was approved for the project the contractor is encouraged to apply the applicable standards to the extent feasible but the Green Building Standard is not required; (ii) for specific which an ENERGY STAR-or-WaterSense-labeled or FEMP-designated product does not exist, the requirement to use such products does not apply. The City encourages contractors to implement green infrastructure policies to the extent practicable.

VIII. ADECA-FUNDED CONTRACTS: The Contractor shall include the following provisions in all construction contracts funded by the Alabama Department of Economic and Community Affairs (ADECA). For all ADECA-funded construction contracts, in the event the provisions contained in this section conflict with provisions contained elsewhere in this document, the provisions contained in this section shall prevail.

A. Section 109 Clause, Housing and Community Development Act of 1974. No person in the United States shall on the grounds of race, color, national origin or sex be excluded from participation in, be denied the benefits of, or be subjected to discrimination under any program or activity funded in whole or in part with funds made available under this title.

B. Notice of Requirement for Affirmative Action to Ensure Equal Employment Opportunity (Executive Order 11246) (applicable to contract/subcontracts exceeding \$10,000). Contractor's attention is called to the "Equal Opportunity Clause" and the "Standard Federal Equal Employment Opportunity Construction Contract Specifications" set forth herein.

The goals and timetables for minority and female participation, expressed in percentage terms for the Contractor's aggregate workforce in each trade on all construction work in the covered area, are as follows:

Goals for Minority Participation (Insert Goals)	Goals for Female Participation (Insert Goals)
--	--

These goals are applicable to all the Contractor's construction work (whether or not it is Federal or Federally assisted) performed in the covered area. If the Contractor performs construction work in a geographic area located outside of the covered area, it shall apply the goals established for such geographic area where the work is actually performed. With regard to this second area, the Contractor also is subject to the goals for both its Federally involved and non-Federally involved construction.

The Contractor's compliance with the Executive Order and the regulations in 41 CFR Part 60-4 shall be based on its implementation of the Equal Opportunity Clause, specific affirmative action obligations required by the specifications set forth in 41 CFR 60-4.3(a), and its efforts to meet the goals established for the geographical area where the contract resulting from this solicitation is to be performed. The hours of minority and female employment and training must be substantially uniform throughout the length of the contract, and in each trade, and the Contractor shall make a good faith effort to employ minorities and women evenly on each of its projects. The transfer of minority or female employees or trainees from Contractor to Contractor or from project to project for the sole purpose of meeting

the Contractor's goals shall be a violation of the Contract, the Executive Order and the regulations in 41 CFR 60-4. Compliance with the goals will be measured against the total work hours performed.

C. "Section 3" Compliance in the Provision of Training, Employment and Business Opportunities.

1. The work to be performed under this Contract is a project assisted under a program providing direct Federal financial assistance from the Department of Housing and Urban Development and is subject to the requirements of Section 3 of the Housing and Urban Development Act of 1968, as amended, 12, U.S.C. 1701u. Section 3 requires that to the greatest extent feasible, opportunities for training and employment be given lower income residents of the project area and contracts for work in connection with the project be awarded to business concerns which are located in, or owned in substantial part by, persons residing in the area of the project.
2. The parties to this Contract will comply with the provisions of said Section 3 and the regulations issued pursuant thereto by the Secretary of Housing and Urban Development set forth in 24 CFR 135, and all applicable rules and orders of the Department issued thereunder prior to the execution of this Contract. The parties to this Contract certify and agree that they are under no contractual or other disability which would prevent them from complying with these requirements.
3. The Contractor will send to each labor organization or representative of workers with which he has a collective bargaining agreement or other contract or understanding, if any, a notice advising the said labor organization or workers' representative of this commitment under this Section 3 clause and shall post copies of the notice in conspicuous places available to employees and applicants for employment or training.
4. The Contractor will include this Section 3 clause in every subcontract for work in connection with the project and will, at the direction of the applicant for or recipient of Federal financial assistance, take appropriate action pursuant to the subcontract upon a finding that the Subcontractor is in violation of regulations issued by the Secretary of Housing and Urban Development, 24 CFR Part 135. The Contractor will not subcontract with any Subcontractor where it has notice or knowledge that the latter has been found in violation of regulations under 24 CFR Part 135 and will not let any subcontract unless the Subcontractor has first provided it with a preliminary statement of ability to comply with the requirements of these regulations.
5. Compliance with the provisions of Section 3, the regulations set forth in 24 CFR Part 135, and all applicable rules and orders of the Department issued hereunder prior to the execution of the Contract, shall be a condition of the Federal financial assistance provided to the project, binding upon the applicant or recipient for such assistance, its successors and assigns. Failure to fulfill these requirements shall subject the applicant or recipient, its contractors and subcontractors, its successors and assigns to those sanctions specified by the grant or loan agreement or contract through which Federal assistance is provided, and to such sanctions as are specified in 24 CFR Part 135.

D. Section 402 Veterans of the Vietnam Era (if \$10,000 or over). Affirmative Action for Disabled Veterans and Veterans of the Vietnam Era.

1. The Contractor will not discriminate against any employee or applicant for employment because he or she is a disabled veteran or veteran of the Vietnam era in regard to any position for which the employee or applicant for employment is qualified. The Contractor agrees to take affirmative action to employ, advance in employment and otherwise treat qualified disabled veterans and veterans of the Vietnam era without discrimination based

on their disability or veteran status in all employment practices such as the following: employment upgrading, demotion or transfer, recruitment, advertising, layoff or termination, rates of pay or other forms of compensation, and selection for training, including apprenticeship.

2. The Contractor agrees that all suitable employment openings of the Contractor which exist at the time of the execution of this Contract and those which occur during the performance of this Contract, including those not generated by this Contract and including those occurring at an establishment of the Contractor other than the one wherein the Contract is being performed but excluding those of independently operated corporate affiliates, shall be listed at an appropriate local office of the State employment service system wherein the opening occurs. The Contractor further agrees to provide such reports to such local office regarding employment openings and hires as may be required. State and local government agencies holding Federal contracts of \$10,000 or more shall also list all their suitable openings with the appropriate office of the State employment service, but are not required to provide those reports set forth in paragraphs 4 and 5.
3. Listing of employment openings with the employment service system pursuant to this clause shall be made at least concurrently with the use of any other recruitment source or effort and shall involve the normal obligations which attach to the placing of a bona fide job order, including the acceptance of referrals of veterans and non-veterans. The listing of employment openings does not require the hiring of any particular job applicant or from any particular group of job applicants, and nothing herein is intended to relieve the Contractor from any requirements in Executive Orders or regulations regarding nondiscrimination in employment.
4. The reports required by paragraph 2 of this clause shall include, but not be limited to, periodic reports which shall be filed at least quarterly with the appropriate local office or, where the Contractor has more than one hiring location in a State, with the central office of that State employment service. Such reports shall indicate for each hiring location (1) the number of individuals hired during the reporting period, (2) the number of nondisabled veterans of the Vietnam era hired, (3) the number of disabled veterans of the Vietnam era hired, and (4) the total number of disabled veterans hired. The reports should include covered veterans hired for on-the-job training under 38 U.S.C.1787. The Contractor shall submit a report within 30 days after the end of each reporting period wherein any performance is made on this Contract identifying data for each hiring location copies of the reports submitted until the expiration of one year after final payment under the Contract, during which time these reports and related documentation shall be made available, upon request, for examination by any authorized representatives of the contracting officer or of the Secretary of Labor. Documentation would include personnel records respecting job openings, recruitment and placement.
5. Whenever the Contractor becomes contractually bound to the listing provisions of this clause, it shall advise the employment service system in each State where it has establishments of the name and location of each hiring location in the State. As long as the Contractor is contractually bound to these provisions and has so advised the State system, there is no need to advise the State system of subsequent contracts. The Contractor may advise the State system when it is no longer bound by the contract clause.
6. This clause does not apply to the listing of employment openings which occur and are filled outside of the 50 states, the District of Columbia, Puerto Rico, Guam and the Virgin Islands.

7. The provisions of paragraphs 2, 3, 4 and 5 of this clause do not apply to openings which the Contractor proposes to fill from within his own organization or to fill pursuant to a customary and traditional employer-union hiring arrangement. This exclusion does not apply to a particular opening once an employer decides to consider applicants outside of his own organization or employer-union arrangement for that opening.
8. As used in this clause:
 - a. "All suitable employment openings" includes, but is not limited to, openings which occur in the following job categories: production and nonproduction; plant and office; laborers and mechanics; supervisory and nonsupervisory; technical; and executive, administrative, and professional openings that are compensated on a salary basis of less than \$25,000 per year. This term includes full-time employment, temporary employment of more than three days' duration, and part-time employment. It does not include openings which the Contractor proposes to fill from within his own organization or to fill pursuant to a customary and traditional employer-union hiring arrangement nor openings in an educational institution which are restricted to students of that institution. Under the most compelling circumstances an employment opening may not be suitable for listing, including such situations where the needs of the Government cannot reasonably be otherwise supplied, where listing would be contrary to national security, or where the requirement of listing would otherwise not be for the best interest of the Government.
 - b. "Appropriate office of the State employment service system" means the local office of the Federal-State national system of public employment offices with assigned responsibility for serving the area where the employment opening is to be filled, including the District of Columbia, Guam, Puerto Rico and the Virgin Islands.
 - c. "Openings which the Contractor proposes to fill from within his own organization" means employment openings for which no consideration will be given to persons outside the Contractor's organization (including any affiliates, subsidiaries, and the parent companies) and includes any openings which the Contractor proposed to fill from regularly established "recall" lists.
 - d. "Openings which the Contractor proposes to fill pursuant to customary and traditional employer-union hiring arrangements" means employment openings which the Contractor proposes to fill from union halls, which is part of the customary and traditional hiring relationship which exists between the Contractor and representatives of his employees.
9. The Contractor agrees to comply with the rules, regulations and relevant orders of the Secretary of Labor issued pursuant to the Act.
10. In the event of the Contractor's non-compliance with the requirements of this clause, actions for non-compliance may be taken in accordance with the rules, regulations and relevant orders of the Secretary of Labor issued pursuant to the Act.
11. The Contractor agrees to post in conspicuous places, available to employees and applicants for employment, notices in a form to be prescribed by the Director, provided by or through the contracting officer. Such notice shall state the Contractor's obligation under the law to take affirmative action to employ and advance in employment qualified disabled veterans and veterans of the Vietnam era for employment, and the rights of applicants and employees.

12. The Contractor will notify each labor union or representative of workers with which it has a collective bargaining agreement or other contract understanding, that the Contractor is bound by the terms of the Vietnam Era Veterans Readjustment Assistance Act, and is committed to take affirmative action to employ and advance in employment qualified disabled veterans and veterans of the Vietnam era.
13. The Contractor will include the provisions of this clause in every subcontract or purchase order of \$10,000 or more unless exempted by rules, regulations or orders of the Secretary issued pursuant to the Act, so that such provisions will be binding upon each Subcontractor or vendor. The Contractor will take such action with respect to any subcontractor or purchase order as the Director of the Office of Federal Contract Compliance Programs may direct to enforce such provisions, including action for non-compliance.

E. Certification of Compliance with Air and Water Acts (applicable to Federally assisted construction contracts and related subcontracts exceeding \$100,000). Compliance with Air and Water Acts. During the performance of this Contract, the Contractor and all Subcontractors shall comply with the requirements of the Clean Air Act, as amended, 42 USC 1857 et seq., the Federal Water Pollution Control Act, as amended, 33 USC 1251 et seq., and the regulations of the Environmental Protection Agency with respect thereto, at 40 CFR Part 15, as amended. In addition to the foregoing requirements, all nonexempt Contractors and Subcontractors shall furnish to the Owner, the following:

1. A stipulation by the Contractor or Subcontractors that any facility to be utilized in the performance of any nonexempt contract or subcontract is not listed on the List of Violating Facilities issued by the Environmental Protection Agency (EPA) pursuant to 40 CFR 15.20.
2. Agreement by the Contractor to comply with all the requirements of Section 114 of the Clean Air Act, as amended, (42 USC 1857c-8) and Section 308 of the Federal Water Pollution Control Act, as amended, (33 USC 1318) relating to inspection, monitoring, entry, reports and information, as well as all other requirements specified in said Section 114 and Section 308, and all regulations and guidelines issued thereunder.
3. A stipulation that as a condition for the Contract, prompt notice will be given of any notification received from the Director, Office of Federal Activities, or EPA indicating that a facility utilized, or to be utilized for the Contract, is under consideration to be listed on the EPA List of Violating Facilities.
4. Agreement by the Contractor that he will include, or cause to be included, the criteria and requirements in paragraphs A through D of this section in every nonexempt subcontract and requiring that the Contractor will take such actions as the Government may direct as a means of enforcing such provisions.

F. Compliance with Copeland Act Requirements. The contractor shall comply with the requirements of 29 CFR Part 3 which are incorporated by reference in this contract.

G. Drug-Free Workplace Requirements. The Drug-Free Workplace Act of 1988 (42 U.S.C. 701) requires grantees (including individuals) of federal agencies, as a prior condition of being awarded a grant, to certify that they will provide drug-free workplaces. Each potential recipient must certify that it will comply with drug-free workplace requirements in accordance with the Act and with HUD's rules at 24 CFR part 24, subpart F.

H. Byrd Anti-Lobbying Amendment (31 U.S.C. 1352). Contractors who apply or bid for an award of \$100,000 or more shall file the required certification. Each tier certifies to the tier above that it will not and has not used Federal appropriated funds to pay any person or organization for influencing or attempting to influence an officer or employee of any agency, a member of Congress, officer or employee of Congress, or an employee of a member of Congress in connection with obtaining any Federal contract, grant or any other award covered by 31 U.S.C. 1352.

Each tier shall also disclose any lobbying with non-Federal funds that takes place in connection with obtaining any Federal award. Such disclosures are forwarded from tier to tier up to the recipient.

IV. DISASTER RECOVERY FUNDED CONTRACTS: ___ The Contractor shall include the following provisions in all Disaster Recover (DR) funded construction contracts. For all DR-funded construction contracts, in the event the provisions contained in this section conflict with provisions contained elsewhere in this document, the provisions contained in this section shall prevail.

A. The Contractor agrees to abide by all applicable Federal regulations in receiving, disbursing and accounting for Community Development Block Grant funds including, but not limited to all applicable sections of 24 CFR 570.

B. ADA Compliance. The Contractor hereby covenants and agrees that, in performing its responsibilities and obligations hereunder, the Contractor, its officers, agents or employees will not, on the grounds of race, color, sex, religion, national origin, disability or age, discriminate or permit discrimination against any person or groups of persons in any manner. The Contractor further agrees to comply with all applicable State and Federal ordinances and regulations, including but not limited to, the Rehabilitation Act of 1973, the Americans with Disabilities Act (ADA), the Civil Rights Act of 1964 and any regulations promulgated there under.

C. Section 3 Compliance. The work to be performed under this contract is subject to the requirements of Section 3 of the Housing and Urban Development Act of 1968, as amended, 12 U.S.C. 1701u (Section 3). The purpose of section 3 is to ensure that employment and other economic opportunities generated by HUD assistance or HUD-assisted projects covered by section 3, shall, to the greatest extent feasible, be directed to low- and very low-income persons, particularly persons who are recipients of HUD assistance for housing. The parties to this contract agree to comply with HUD's regulations in 24 CFR Part 135, which implement section 3. As evidenced by their execution of this contract, the parties to this contract certify that they are under no contractual or other impediment that would prevent them from complying with the part 135 regulations. Contractor agrees to send to each labor organization or representative of workers with which the Contractor has a collective bargaining agreement or other understanding, if any, a notice advising the labor organization or workers' representative of the Contractor's commitments under this section 3 clause, and will post copies of the notice in conspicuous places at the work site where both employees and applicants for training and employment positions can see the notice. The notice shall describe the section 3 preference, shall set forth minimum number and job titles subject to hire, availability of apprenticeship and training positions, the qualifications for each; and the name and location of the person(s) taking applications for each of the positions; and the anticipated date the work shall begin. Contractor agrees to include this section 3 clause in every subcontract subject to compliance with regulations in 24 CFR Part 135, and agrees to take appropriate action, as provided in an applicable provision of the subcontract or in this section 3 clause, upon a finding that the subcontractor is in violation of the regulations in 24 CFR Part 135. Contractor will not subcontract with any subcontractor where the Contractor has notice or knowledge that the subcontractor has been found in violation of the regulations in 24 CFR Part 135. Contractor will certify that any vacant employment positions, including training positions, that are filled (1) after Contractor is selected by before the contract is executed, and (2) with persons other than those to whom the regulations of 24 CFR part 135 require employment opportunities to be directed, were not filled to circumvent the Contractor's obligations under 24 CFR part 135. Noncompliance with HUD's regulations in 24 CFR Part 135 may result in sanctions, termination of this contract for default, and debarment or suspension from future HUD assisted contracts.

D. Section 109 Compliance. No person in the United States will, on the ground of race, color, national origin, religion, or sex, be excluded from participation in, be denied the benefits of, or be subjected to discrimination under any program or activity administered of provided under this Agreement, pursuant to Section 109 of title I of the Housing and Community Development Act of 1974 (Title I) (42 U.S.C. 5309).

E. Section 402 Compliance. Contractors and subcontractors shall take affirmative action to employ and advance in employment qualified covered veterans. Disabled veterans, recently separated veterans (veterans within 3

years of their discharge or release from active duty), veterans who served on active duty during a war or in a campaign or expedition for which a campaign badge has been authorized (referred to as "other protected veterans"), and Armed Forces service medal veterans are covered veterans under VEVRAA, pursuant to the Vietnam Era Veterans' Readjustment Assistance Act of 1974, as amended (VEVRAA).

F. Copeland Anti-Kickback Act Compliance. Pursuant to The Copeland "Anti-Kickback" Act, 40 USC §3145 and 18 USC §874, no contractor or subcontractor operating under this agreement shall induce an employee to give up any part of the compensation to which he or she is entitled under his or her contract of employment. Contractors and subcontractors shall submit a weekly statement of the wages paid to each employee performing on covered work during the preceding payroll period.

G. Affirmative Action. During the performance of this contract, the contractors and subcontractors operating under this agreement shall not discriminate against any employee or applicant for employment because of race, color, religion, sex, or national origin. The Contractor will take affirmative action to ensure that applicants are employed, and that employees are treated during employment, without regard to their race, color, religion, sex, or national origin. Contractors and subcontractors operating under this agreement shall comply with Affirmative Action laws and regulations to ensure equal employment opportunities, including, but not limited to 41 CFR Part 60-1; 41 CFR Part 60-2; 41 CFR Part 60-250; 41 CFR Part 60-741; compliance with E.O. 11246, "Equal Employment Opportunity," as amended by E.O. 11375, "Amending Executive Order 11246 Relating to Equal Employment Opportunity."

H. Compliance with Goals for Minority and Female Participation. The City of Tuscaloosa has voluntarily adopted a Minority / Disadvantaged Business Enterprise ("MBE/DBE/WBE") Program designed to encourage the participation and development of minority and disadvantaged business enterprises and to promote equal business opportunities to the fullest extent allowed by state and federal law. It is the intent of the City to foster competition among contractors, suppliers, and vendors that will result in better quality and more economical services rendered to the City. Under this policy, the City of Tuscaloosa has established a goal of ten to twenty percent (10-20%) inclusion of minority and disadvantaged business enterprises for all services required to deliver City projects. In no case shall the stated percentage be the determining factor in contract awards. Rather, contractors must demonstrate a good faith effort to attain the desired percentage goal. The Developer is encouraged to adopt corresponding goals to those of the City's Minority / Disadvantaged Business Enterprise ("MBE/DBE/WBE") Program.

I. Compliance with Environmental Laws; including The Clean Air Act and Clean Water Act. Contractors and subcontractors operating under this agreement shall be responsible for ensuring compliance with Federal, State, or local pollution control laws and related requirements, including but not limited to the Clean Air Act (42 U.S.C. 7401 et seq.) and the Federal Water Pollution Control Act as amended (33 U.S.C. 1251 et seq.). If a contracting officer becomes aware of noncompliance with clean air or water standards in facilities used in performing nonexempt contracts, that contracting officer shall notify the agency head, or a designee, who shall promptly notify the EPA Administrator or a designee in writing.

J. Byrd Anti-Lobbying Agreement. Contractors operating under this agreement shall file the required certification under the Byrd Anti-Lobbying Amendment (31 U.S.C. 1352). Each tier certifies to the tier above that it will not and has not used Federal appropriated funds to pay any person or organization for influencing or attempting to influence an officer or employee of any agency, a member of Congress, officer or employee of Congress, or an employee of a member of Congress in connection with obtaining any Federal contract, grant or any other award covered by 31 U.S.C. 1352. Each tier shall also disclose any lobbying with non-Federal funds that takes place in connection with obtaining any Federal award. Such disclosures are forwarded from tier to tier up to the recipient.

K. HUD Form 4010 See next page.

V. **REQUIRED NOTICE ON LOBBYING:** Applicants/bidders for a lower tier covered transaction (except procurement contracts for good and services under \$25,000 not requiring the consent of a DOC official) are subject to 2 C.F.R. part 1326, subpart C, "Governmentwide Debarment and Suspension (Nonprocurement)." In addition, applicants/bidders for a lower tier covered transaction for a subaward, contract, or subcontract greater than \$100,000 of Federal funds at any tier are subject to 15 C.F.R. part 28, "New Restrictions on Lobbying."

Applicants/bidders should familiarize themselves with these provisions, including the certification requirement. Therefore, applications for a lower tier covered transaction must include a Form CD-512, "Certification Regarding Lobbying- Lower Tier Covered Transactions," completed without modification.

VI. REQUIRED FEDERAL EQUAL EMPLOYMENT OPPORTUNITY CLAUSES: Standard Federal Equal Employment Opportunity Construction Contract Specifications (Executive Order 11246)

A. As used in these specifications:

1. "Covered area" means the geographical area described in the solicitation from which this contract resulted;
2. "Director" means Director, Office of Federal Contract Compliance Programs, United States Department of Labor, or any person to whom the Director delegates authority;
3. "Employer identification number" means the Federal Social Security number used on the Employer's Quarterly Federal Tax Return, U.S. Treasury Department Form 941.
4. "Minority" includes:
 - a. Black (all persons having origins in any of the Black African racial groups not of Hispanic origin);
 - b. Hispanic (all persons of Mexican, Puerto Rican, Cuban, Central or South American or other Spanish Culture or origin, regardless of race);
 - c. Asian and Pacific Islander (all persons having origins in any of the original peoples of the Far East, Southeast Asia, the Indian Subcontinent, or the Pacific Islands); and
 - d. American Indian or Alaskan Native (all persons having origins in any of the original peoples of North America and maintaining identifiable tribal affiliations through membership and participation or community identification).

B. Whenever the Contractor, or any Subcontractor at any tier, subcontracts a portion of the work involving any construction trade, it shall physically include in each subcontract in excess of \$10,000 the provisions of these specifications and the Notice which contains the applicable goals for minority and female participation and which is set forth in the solicitations from which this contract resulted.

C. If the Contractor is participating (pursuant to 41 CFR 60-4.5) in a Hometown Plan approved by the U.S. Department of Labor in the covered area either individually or through an association, its affirmative action obligations on all work in the Plan area (including goals and timetables) shall be in accordance with that Plan for those trades which have unions participating in the Plan. Contractors must be able to demonstrate their participation in and compliance with the provisions of any such Hometown Plan. Each Contractor or Subcontractor participating in an approved Plan is individually required to comply with its obligations under the EEO clause, and to make a good faith effort to achieve each goal under the Plan in each trade in which it has employees. The overall good faith performance by other Contractors or Subcontractors toward a goal in an approved Plan does not excuse any covered Contractor's or Subcontractor's failure to take good faith efforts to achieve the Plan goals

and timetables.

D. The Contractor shall implement the specific affirmative action standards provided in paragraphs 7 a through p of these specifications. The goals set forth in the solicitation from which this contract resulted are expressed as percentages of the total hours of employment and training of minority and female utilization the Contractor should reasonably be able to achieve in each construction trade in which it has employees in the covered area. Covered Construction contractors performing construction work in geographical areas where they do not have a Federal or federally assisted construction contract shall apply the minority and female goals established for the geographical area where the work is being performed. Goals are published periodically in the Federal Register in notice form, and such notices may be obtained from any Office of Federal Contract Compliance Programs office or from Federal procurement contracting officers. The Contractor is expected to make substantially uniform progress in meeting its goals in each craft during the period specified.

E. Neither the provisions of any collective bargaining agreement, nor the failure by a union with whom the Contractor has a collective bargaining agreement, to refer either minorities or women shall excuse the Contractor's obligations under these specifications, Executive Order 11246, or the regulations promulgated pursuant thereto.

F. In order for the nonworking training hours of apprentices and trainees to be counted in meeting the goals, such apprentices and trainees must be employed by the Contractor during the training period, and the Contractor must have made a commitment to employ the apprentices and trainees at the completion of their training, subject to the availability of employment opportunities. Trainees must be trained pursuant to training programs approved by the U.S. Department of Labor.

G. The Contractor shall take specific affirmative actions to ensure equal employment opportunity. The evaluation of the Contractor's compliance with these specifications shall be based upon its effort to achieve maximum results from its actions. The Contractor shall document these efforts fully, and shall implement affirmative action steps at least as extensive as the following:

1. Ensure and maintain a working environment free of harassment, intimidation, and coercion at all sites, and in all facilities at which the Contractor's employees are assigned to work. The Contractor, where possible, will assign two or more women to each construction project. The Contractor shall specifically ensure that all foremen, superintendents, and other on-site supervisory personnel are aware of and carry out the Contractor's obligation to maintain such a working environment, with specific attention to minority or female individuals working at such sites or in such facilities.
2. Establish and maintain a current list of minority and female recruitment sources, provide written notification to minority and female recruitment sources and to community organizations when the Contractor or its unions have employment opportunities available, and maintain a record of the organizations' responses.
3. Maintain a current file of the names, addresses and telephone numbers of each minority and female off-the-street applicant and minority or female referral from a union, a recruitment source or community organization and of what action was taken with respect to each such individual. If such individual was sent to the union hiring hall for referral and was not referred back to the Contractor by the union or, if referred, not employed by the Contractor, this shall be documented in the file with the reason therefor, along with whatever additional actions the Contractor may have taken.

4. Provide immediate written notification to the Director when the union or unions with which the Contractor has a collective bargaining agreement has not referred to the Contractor a minority person or woman sent by the Contractor, or when the Contractor has other information that the union referral process has impeded the Contractor's efforts to meet its obligations.

5. Develop on-the-job training opportunities and/or participate in training programs for the area which expressly include minorities and women, including upgrading programs and apprenticeship and trainee programs relevant to the Contractor's employment needs, especially those programs funded or approved by the Department of Labor. The Contractor shall provide notice of these programs to the sources compiled under 7b above.

6. Disseminate the Contractor's EEO policy by providing notice of the policy to unions and training programs and requesting their cooperation in assisting the Contractor in meeting its EEO obligations; by including it in any policy manual and collective bargaining agreement; by publicizing it in the company newspaper, annual report, etc.; by specific review of the policy with all management personnel and with all minority and female employees at least once a year; and by posting the company EEO policy on bulletin boards accessible to all employees at each location where construction work is performed.

7. Review, at least annually, the company's EEO policy and affirmative action obligations under these specifications with all employees having any responsibility for hiring, assignment, layoff, termination or other employment decisions including specific review of these items with onsite supervisory personnel such as Superintendents, General Foremen, etc., prior to the initiation of construction work at any job site. A written record shall be made and maintained identifying the time and place of these meetings, persons attending, subject matter discussed, and disposition of the subject matter.

8. Disseminate the Contractor's EEO policy externally by including it in any advertising in the news media, specifically including minority and female news media, and providing written notification to and discussing the Contractor's EEO policy with other Contractors and Subcontractors with whom the Contractor does or anticipates doing business.

9. Direct its recruitment efforts, both oral and written, to minority, female and community organizations, to schools with minority and female students and to minority and female recruitment and training organizations serving the Contractor's recruitment area and employment needs. Not later than one month prior to the date for the acceptance of applications for apprenticeship or other training by any recruitment source, the Contractor shall send written notification to organizations such as the above, describing the openings, screening procedures, and tests to be used in the selection process.

10. Encourage present minority and female employees to recruit other minority persons and women and, where reasonable, provide after school, summer and vacation employment to minority and female youth both on the site and in other areas of a Contractor's work force.

11. Validate all tests and other selection requirements where there is an obligation to do so under 41 CFR part 60-3.

12. Conduct, at least annually, an inventory and evaluation at least of all minority and female personnel for promotional opportunities and encourage these employees to seek or to prepare for, through appropriate

training, etc., such opportunities.

13. Ensure that seniority practices, job classifications, work assignments and other personnel practices, do not have a discriminatory effect by continually monitoring all personnel and employment related activities to ensure that the EEO policy and the Contractor's obligations under these specifications are being carried out.

14. Ensure that all facilities and company activities are nonsegregated except that separate or single-user toilet and necessary changing facilities shall be provided to assure privacy between the sexes.

15. Document and maintain a record of all solicitations of offers for subcontracts from minority and female construction contractors and suppliers, including circulation of solicitations to minority and female contractor associations and other business associations.

16. Conduct a review, at least annually, of all supervisors' adherence to and performance under the Contractor's EEO policies and affirmative action obligations.

H. Contractors are encouraged to participate in voluntary associations which assist in fulfilling one or more of their affirmative action obligations (7a through p). The efforts of a contractor association, joint contractor-union, contractor-community, or other similar group of which the contractor is a member and participant, may be asserted as fulfilling any one or more of its obligations under 7a through p of these Specifications provided that the contractor actively participates in the group, makes every effort to assure that the group has a positive impact on the employment of minorities and women in the industry, ensures that the concrete benefits of the program are reflected in the Contractor's minority and female workforce participation, makes a good faith effort to meet its individual goals and timetables, and can provide access to documentation which demonstrates the effectiveness of actions taken on behalf of the Contractor. The obligation to comply, however, is the Contractor's and failure of such a group to fulfill an obligation shall not be a defense for the Contractor's noncompliance.

I. A single goal for minorities and a separate single goal for women have been established. The Contractor, however, is required to provide equal employment opportunity and to take affirmative action for all minority groups, both male and female, and all women, both minority and non-minority. Consequently, the Contractor may be in violation of the Executive Order if a particular group is employed in a substantially disparate manner (for example, even though the Contractor has achieved its goals for women generally, the Contractor may be in violation of the Executive Order if a specific minority group of women is underutilized).

J. The Contractor shall not use the goals and timetables or affirmative action standards to discriminate against any person because of race, color, religion, sex, sexual orientation, gender identity, or national origin.

K. The Contractor shall not enter into any Subcontract with any person or firm debarred from Government contracts pursuant to Executive Order 11246.

L. The Contractor shall carry out such sanctions and penalties for violation of these specifications and of the Equal Opportunity Clause, including suspension, termination and cancellation of existing subcontracts as may be imposed or ordered pursuant to Executive Order 11246, as amended, and its implementing regulations, by the Office of Federal Contract Compliance Programs. Any Contractor who fails to carry out such sanctions and penalties shall be in violation of these specifications and Executive Order 11246, as amended.

M. The Contractor, in fulfilling its obligations under these specifications, shall implement specific affirmative action steps, at least as extensive as those standards prescribed in paragraph 7 of these specifications, so as to achieve maximum results from its efforts to ensure equal employment opportunity. If the Contractor fails to comply with the requirements of the Executive Order, the implementing regulations, or these specifications, the Director shall proceed in accordance with 41 CFR 60-4.8.

N. The Contractor shall designate a responsible official to monitor all employment related activity to ensure that the company EEO policy is being carried out, to submit reports relating to the provisions hereof as may be required by the Government and to keep records. Records shall at least include for each employee the name, address, telephone numbers, construction trade, union affiliation if any, employee identification number when assigned, social security number, race, sex, status (e.g., mechanic, apprentice trainee, helper, or laborer), dates of changes in status, hours worked per week in the indicated trade, rate of pay, and locations at which the work was performed. Records shall be maintained in an easily understandable and retrievable form; however, to the degree that existing records satisfy this requirement, contractors shall not be required to maintain separate records.

O. Nothing herein provided shall be construed as a limitation upon the application of other laws which establish different standards of compliance or upon the application of requirements for the hiring of local or other area residents (e.g., those under the Public Works Employment Act of 1977 and the Community Development Block Grant Program).

Federal Labor Standards Provisions

U.S. Department of Housing and Urban Development Office of Labor Relations

Applicability

The Project or Program to which the construction work covered by this contract pertains is being assisted by the United States of America and the following Federal Labor Standards Provisions are included in this Contract pursuant to the provisions applicable to such Federal assistance.

A. 1. (i) **Minimum Wages.** All laborers and mechanics employed or working upon the site of the work, will be paid unconditionally and not less often than once a week, and without subsequent deduction or rebate on any account (except such payroll deductions as are permitted by regulations issued by the Secretary of Labor under the Copeland Act (29 CFR Part 3), the full amount of wages and bona fide fringe benefits (or cash equivalents thereof) due at time of payment computed at rates not less than those contained in the wage determination of the Secretary of Labor which is attached hereto and made a part hereof, regardless of any contractual relationship which may be alleged to exist between the contractor and such laborers and mechanics. Contributions made or costs reasonably anticipated for bona fide fringe benefits under Section 1(b)(2) of the Davis-Bacon Act on behalf of laborers or mechanics are considered wages paid to such laborers or mechanics, subject to the provisions of 29 CFR 5.6(e)(1)(iv); also, regular contributions made or costs incurred for more than a weekly period (but not less often than quarterly) under plans, funds, or programs, which cover the particular weekly period, are deemed to be constructively made or incurred during such weekly period.

Such laborers and mechanics shall be paid the appropriate wage rate and fringe benefits on the wage determination for the classification of work actually performed, without regard to skill, except as provided in 29 CFR 5.6(a)(4). Laborers or mechanics performing work in more than one classification may be compensated at the rate specified for each classification for the time actually worked therein: Provided, That the employer's payroll records accurately set forth the time spent in each classification in which work is performed. The wage determination (including any additional classification and wage rates conformed under 29 CFR 5.6(e)(1)(ii) and the Davis-Bacon poster (WH-1321) shall be posted at all times by the contractor and its subcontractors at the site of the work in a prominent and accessible, place where it can be easily seen by the workers.

(ii) (a) Any class of laborers or mechanics which is not listed in the wage determination and which is to be employed under the contract shall be classified in conformance with the wage determination. HUD shall approve an additional classification and wage rate and fringe benefits therefor only when the following criteria have been met:

(1) The work to be performed by the classification requested is not performed by a classification in the wage determination; and

(2) The classification is utilized in the area by the construction industry; and

(3) The proposed wage rate, including any bona fide fringe benefits, bears a reasonable relationship to the wage rates contained in the wage determination.

(b) If the contractor and the laborers and mechanics to be employed in the classification (if known), or their representatives, and HUD or its designee agree on the classification and wage rate (including the amount designated for fringe benefits where appropriate), a report of the action taken shall be sent by HUD or its designee to the Administrator of the Wage and Hour Division, Employment Standards Administration, U.S. Department of Labor, Washington, D.C. 20210. The Administrator, or an authorized representative, will approve, modify, or disapprove every additional classification action within 30 days of receipt and so advise HUD or its designee or will notify HUD or its designee within the 30-day period that additional time is necessary. (Approved by the Office of Management and Budget under OMB control number 1215-0140.)

(c) In the event the contractor, the laborers or mechanics to be employed in the classification or their representatives, and HUD or its designee do not agree on the proposed classification and wage rate (including the amount designated for fringe benefits, where appropriate), HUD or its designee shall refer the questions, including the views of all interested parties and the recommendation of HUD or its designee, to the Administrator for determination. The Administrator, or an authorized representative, will issue a determination within 30 days of receipt and so advise HUD or its designee or will notify HUD or its designee within the 30-day period that additional time is necessary. (Approved by the Office of Management and Budget under OMB Control Number 1215-0140.)

(d) The wage rate (including fringe benefits where appropriate) determined pursuant to subparagraphs (1)(ii)(b) or (c) of this paragraph, shall be paid to all workers performing work in the classification under this contract from the first day on which work is performed in the classification.

(iii) Whenever the minimum wage rate prescribed in the contract for a class of laborers or mechanics includes a fringe benefit which is not expressed as an hourly rate, the contractor shall either pay the benefit as stated in the wage determination or shall pay another bona fide fringe benefit or an hourly cash equivalent thereof.

(iv) If the contractor does not make payments to a trustee or other third person, the contractor may consider as part

of the wages of any laborer or mechanic the amount of any costs reasonably anticipated in providing bona fide fringe benefits under a plan or program, Provided, That the Secretary of Labor has found, upon the written request of the contractor, that the applicable standards of the Davis-Bacon Act have been met. The Secretary of Labor may require the contractor to set aside in a separate account assets for the meeting of obligations under the plan or program. (Approved by the Office of Management and Budget under OMB Control Number 1215-0140.)

2. **Withholding.** HUD or its designee shall upon its own action or upon written request of an authorized representative of the Department of Labor withhold or cause to be withheld from the contractor under this contract or any other Federal contract with the same prime contractor, or any other Federally-assisted contract subject to Davis-Bacon prevailing wage requirements, which is held by the same prime contractor so much of the accrued payments or advances as may be considered necessary to pay laborers and mechanics, including apprentices, trainees and helpers, employed by the contractor or any subcontractor the full amount of wages required by the contract in the event of failure to pay any laborer or mechanic, including any apprentice, trainee or helper, employed or working on the site of the work, all or part of the wages required by the contract, HUD or its designee may, after written notice to the contractor, sponsor, applicant, or owner, take such action as may be necessary to cause the suspension of any further payment, advance, or guarantee of funds until such violations have ceased. HUD or its designee may, after written notice to the contractor, disburse such amounts withheld for and on account of the contractor or subcontractor to the respective employees to whom they are due. The Comptroller General shall make such disbursements in the case of direct Davis-Bacon Act contracts.

3. (i) **Payrolls and basic records.** Payrolls and basic records relating thereto shall be maintained by the contractor during the course of the work preserved for a period of three years thereafter for all laborers and mechanics working at the site of the work. Such records shall contain the name, address, and social security number of each such worker, his or her correct classification, hourly rates of wages paid (including rates of contributions or costs anticipated for bona fide fringe benefits or cash equivalents thereof of the types described in Section 1(b)(2)(B) of the Davis-Bacon Act), daily and weekly number of hours worked, deductions made and actual wages paid. Whenever the Secretary of Labor has found under 29 CFR 5.5 (a)(1)(iv) that the wages of any laborer or mechanic include the amount of any costs reasonably anticipated in providing benefits under a plan or program described in Section 1(b)(2)(B) of the Davis-Bacon Act, the contractor shall maintain records which show that the commitment to provide such benefits is enforceable, that the plan or program is financially responsible, and that the plan or program has been

communicated in writing to the laborers or mechanics affected, and records which show the costs anticipated or the actual cost incurred in providing such benefits. Contractors employing apprentices or trainees under approved programs shall maintain written evidence of the registration of apprenticeship programs and certification of trainee programs, the registration of the apprentices and trainees, and the ratios and wage rates prescribed in the applicable programs. (Approved by the Office of Management and Budget under OMB Control Numbers 1215-0140 and 1215-0017.)

(ii) (a) The contractor shall submit weekly for each week in which any contract work is performed a copy of all payrolls to HUD or its designee if the agency is a party to the contract, but if the agency is not such a party, the contractor will submit the payrolls to the applicant sponsor, or owner, as the case may be, for transmission to HUD or its designee. The payrolls submitted shall set out accurately and completely all of the information required to be maintained under 29 CFR 5.5(a)(3)(i) except that full social security numbers and home addresses shall not be included on weekly transmittals. Instead the payrolls shall only need to include an individually identifying number for each employee (e.g., the last four digits of the employee's social security number). The required weekly payroll information may be submitted in any form desired. Optional Form WH-347 is available for this purpose from the Wage and Hour Division Web site at <http://www.dol.gov/eisa/whd/forms/wh347instr.htm> or its successor site. The prime contractor is responsible for the submission of copies of payrolls by all subcontractors. Contractors and subcontractors shall maintain the full social security number and current address of each covered worker, and shall provide them upon request to HUD or its designee if the agency is a party to the contract, but if the agency is not such a party, the contractor will submit the payrolls to the applicant sponsor, or owner, as the case may be, for transmission to HUD or its designee, the contractor, or the Wage and Hour Division of the Department of Labor for purposes of an investigation or audit of compliance with prevailing wage requirements. It is not a violation of this subparagraph for a prime contractor to require a subcontractor to provide addresses and social security numbers to the prime contractor for its own records, without weekly submission to HUD or its designee. (Approved by the Office of Management and Budget under OMB Control Number 1215-0149.)

(b) Each payroll submitted shall be accompanied by a "Statement of Compliance," signed by the contractor or subcontractor or his or her agent who pays or supervises the payment of the persons employed under the contract and shall certify the following:

(1) That the payroll for the payroll period contains the information required to be provided under 29 CFR 5.5 (a)(3)(i), the appropriate information is being maintained under 29 CFR 5.5(a)(3)(i), and that such information is correct and complete;

Previous editions are obsolete

(2) That each laborer or mechanic (including each helper, apprentice, and trainee) employed on the contract during the payroll period has been paid the full weekly wages earned, without rebate, either directly or indirectly, and that no deductions have been made either directly or indirectly from the full wages earned, other than permissible deductions as set forth in 29 CFR Part 3;

(3) That each laborer or mechanic has been paid not less than the applicable wage rates and fringe benefits or cash equivalents for the classification of work performed, as specified in the applicable wage determination incorporated into the contract.

(c) The weekly submission of a properly executed certification set forth on the reverse side of Optional Form WH-347 shall satisfy the requirement for submission of the "Statement of Compliance" required by subparagraph A.3.(1)(b).

(d) The falsification of any of the above certifications may subject the contractor or subcontractor to civil or criminal prosecution under Section 1001 of Title 18 and Section 231 of Title 31 of the United States Code.

(iii) The contractor or subcontractor shall make the records required under subparagraph A.3.(1) available for inspection, copying, or transcription by authorized representatives of HUD or its designee or the Department of Labor, and shall permit such representatives to interview employees during working hours on the job. If the contractor or subcontractor fails to submit the required records or to make them available, HUD or its designee may, after written notice to the contractor, sponsor, applicant or owner, take such action as may be necessary to cause the suspension of any further payment, advance, or guarantee of funds. Furthermore, failure to submit the required records upon request or to make such records available may be grounds for debarment action pursuant to 29 CFR 5.12.

4. Apprentices and Trainees.

(1) Apprentices. Apprentices will be permitted to work at less than the predetermined rate for the work they performed when they are employed pursuant to and individually registered in a bona fide apprenticeship program registered with the U.S. Department of Labor, Employment and Training Administration, Office of Apprenticeship Training, Employer and Labor Services, or with a State Apprenticeship Agency recognized by the Office, or if a person is employed in his or her first 90 days of probationary employment as an apprentice in such an apprenticeship program, who is not individually registered in the program, but who has been certified by the Office of Apprenticeship Training, Employer and Labor Services or a State Apprenticeship Agency (where appropriate) to be eligible for probationary employment as an apprentice. The allowable ratio of apprentices to journeymen on the job site in any craft classification shall not be greater than the ratio permitted to the contractor as to the entire work force under the registered program. Any worker listed on a payroll at an apprentice wage rate, who

is not registered or otherwise employed as stated above, shall be paid not less than the applicable wage rate on the wage determination for the classification of work actually performed. In addition, any apprentice performing work on the job site in excess of the ratio permitted under the registered program shall be paid not less than the applicable wage rate on the wage determination for the work actually performed. Where a contractor is performing construction on a project in a locality other than that in which its program is registered, the ratios and wage rates (expressed in percentages of the journeyman's hourly rate) specified in the contractor's or subcontractor's registered program shall be observed. Every apprentice must be paid at not less than the rate specified in the registered program for the apprentice's level of progress, expressed as a percentage of the journeymen hourly rate specified in the applicable wage determination. Apprentices shall be paid fringe benefits in accordance with the provisions of the apprenticeship program. If the apprenticeship program does not specify fringe benefits, apprentices must be paid the full amount of fringe benefits listed on the wage determination for the applicable classification. If the Administrator determines that a different practice prevails for the applicable apprentice classification, fringes shall be paid in accordance with that determination. In the event the Office of Apprenticeship Training, Employer and Labor Services, or a State Apprenticeship Agency recognized by the Office, withdraws approval of an apprenticeship program, the contractor will no longer be permitted to utilize apprentices at less than the applicable predetermined rate for the work performed until an acceptable program is approved.

(1) Trainees. Except as provided in 29 CFR 5.16, trainees will not be permitted to work at less than the predetermined rate for the work performed unless they are employed pursuant to and individually registered in a program which has received prior approval, evidenced by formal certification by the U.S. Department of Labor, Employment and Training Administration. The ratio of trainees to journeymen on the job site shall not be greater than permitted under the plan approved by the Employment and Training Administration. Every trainee must be paid at not less than the rate specified in the approved program for the trainee's level of progress, expressed as a percentage of the journeyman hourly rate specified in the applicable wage determination. Trainees shall be paid fringe benefits in accordance with the provisions of the trainee program. If the trainee program does not mention fringe benefits, trainees shall be paid the full amount of fringe benefits listed on the wage determination unless the Administrator of the Wage and Hour Division determines that there is an apprenticeship program associated with the corresponding journeyman wage rate on the wage determination which provides for less than full fringe benefits for apprentices. Any employee listed on the payroll at a trainee rate who is not registered and participating in a training plan approved by

Previous editions are obsolete

the Employment and Training Administration shall be paid not less than the applicable wage rate on the wage determination for the work actually performed. In addition, any trainee performing work on the job site in excess of the ratio permitted under the registered program shall be paid not less than the applicable wage rate on the wage determination for the work actually performed. In the event the Employment and Training Administration withdraws approval of a training program, the contractor will no longer be permitted to utilize trainees at less than the applicable predetermined rate for the work performed until an acceptable program is approved.

(III) Equal employment opportunity. The utilization of apprentices, trainees and journeymen under 29 CFR Part 5 shall be in conformity with the equal employment opportunity requirements of Executive Order 11246, as amended, and 29 CFR Part 30.

6. Compliance with Copeland Act requirements. The contractor shall comply with the requirements of 29 CFR Part 3 which are incorporated by reference in this contract

6. Subcontracts. The contractor or subcontractor will insert in any subcontracts the clauses contained in subparagraphs 1 through 11 in this paragraph A and such other clauses as HUD or its designee may by appropriate instructions require, and a copy of the applicable prevailing wage decision, and also a clause requiring the subcontractors to include these clauses in any lower tier subcontracts. The prime contractor shall be responsible for the compliance by any subcontractor or lower tier subcontractor with all the contract clauses in this paragraph.

7. Contract termination; debarment. A breach of the contract clauses in 29 CFR 5.5 may be grounds for termination of the contract and for debarment as a contractor and a subcontractor as provided in 29 CFR 5.12.

8. Compliance with Davis-Bacon and Related Act Requirements. All rulings and interpretations of the Davis-Bacon and Related Acts contained in 29 CFR Parts 1, 3, and 5 are herein incorporated by reference in this contract

9. Disputes concerning labor standards. Disputes arising out of the labor standards provisions of this contract shall not be subject to the general disputes clause of this contract. Such disputes shall be resolved in accordance with the procedures of the Department of Labor set forth in 29 CFR Parts 5, 6, and 7. Disputes within the meaning of this clause include disputes between the contractor (or any of its subcontractors) and HUD or its designee, the U.S. Department of Labor, or the employees or their representatives.

10. (i) Certification of Eligibility. By entering into this contract the contractor certifies that neither it (nor he or she) nor any person or firm who has an interest in the contractor's firm is a person or firm ineligible to be awarded Government contracts by virtue of Section 3(a) of the Davis-Bacon Act or 29 CFR 5.12(a)(1) or to be

awarded HUD contracts or participate in HUD programs pursuant to 24 CFR Part 24.

(ii) No part of this contract shall be subcontracted to any person or firm ineligible for award of a Government contract by virtue of Section 3(a) of the Davis-Bacon Act or 29 CFR 5.12(a)(1) or to be awarded HUD contracts or participate in HUD programs pursuant to 24 CFR Part 24.

(iii) The penalty for making false statements is prescribed in the U.S. Criminal Code, 18 U.S.C. 1001. Additionally, U.S. Criminal Code, Section 1 01 0, Title 18, U.S.C., "Federal Housing Administration transactions", provides in part: "Whoever, for the purpose of . . . influencing in any way the action of such Administration..... makes, utters or publishes any statement knowing the same to be false..... shall be fined not more than \$5,000 or imprisoned not more than two years, or both."

11. Complaints, Proceedings, or Testimony by Employees. No laborer or mechanic to whom the wage, salary, or other labor standards provisions of this Contract are applicable shall be discharged or in any other manner discriminated against by the Contractor or any subcontractor because such employee has filed any complaint or instituted or caused to be instituted any proceeding or has testified or is about to testify in any proceeding under or relating to the labor standards applicable under this Contract to his employer.

B. Contract Work Hours and Safety Standards Act. The provisions of this paragraph B are applicable where the amount of the prime contract exceeds \$100,000. As used in this paragraph, the terms "laborers" and "mechanics" include watchmen and guards.

(1) Overtime requirements. No contractor or subcontractor contracting for any part of the contract work which may require or involve the employment of laborers or mechanics shall require or permit any such laborer or mechanic in any workweek in which the individual is employed on such work to work in excess of 40 hours in such workweek unless such laborer or mechanic receives compensation at a rate not less than one and one-half times the basic rate of pay for all hours worked in excess of 40 hours in such workweek.

(2) Violation; liability for unpaid wages; liquidated damages. In the event of any violation of the clause set forth in subparagraph (1) of this paragraph, the contractor and any subcontractor responsible therefor shall be liable for the unpaid wages. In addition, such contractor and subcontractor shall be liable to the United States (in the case of work done under contract for the District of Columbia or a territory, to such District or to such territory), for liquidated damages. Such liquidated damages shall be computed with respect to each individual laborer or mechanic, including watchmen and guards, employed in violation of the clause set forth in subparagraph (1) of this paragraph, in the sum of \$10 for each calendar day on which such individual was required or permitted to work in excess of the standard workweek of 40 hours without payment of the overtime wages required by the clause set forth in subparagraph (1) of this paragraph.

(3) **Withholding for unpaid wages and liquidated damages.** HUD or its designee shall upon its own action or upon written request of an authorized representative of the Department of Labor withhold or cause to be withheld, from any moneys payable on account of work performed by the contractor or subcontractor under any such contract or any other Federal contract with the same prime contract, or any other Federally-assisted contract subject to the Contract Work Hours and Safety Standards Act which is held by the same prime contractor such sums as may be determined to be necessary to satisfy any liabilities of such contractor or subcontractor for unpaid wages and liquidated damages as provided in the clause set forth in subparagraph (2) of this paragraph.

(4) **Subcontracts.** The contractor or subcontractor shall insert in any subcontracts the clauses set forth in subparagraph (1) through (4) of this paragraph and also a clause requiring the subcontractors to include these clauses in any lower tier subcontracts. The prime contractor shall be responsible for compliance by any subcontractor or lower tier subcontractor with the clauses set forth in subparagraphs (1) through (4) of this paragraph.

C. Health and Safety. The provisions of this paragraph C are applicable where the amount of the prime contract exceeds \$100,000.

(1) No laborer or mechanic shall be required to work in surroundings or under working conditions which are unsanitary, hazardous, or dangerous to his health and safety as determined under construction safety and health standards promulgated by the Secretary of Labor by regulation.

(2) The Contractor shall comply with all regulations issued by the Secretary of Labor pursuant to Title 29 Part 1926 and failure to comply may result in imposition of sanctions pursuant to the Contract Work Hours and Safety Standards Act, (Public Law 91-54, 83 Stat 96). 40 USC 3701 et seq.

(3) The contractor shall include the provisions of this paragraph in every subcontract so that such provisions will be binding on each subcontractor. The contractor shall take such action with respect to any subcontractor as the Secretary of Housing and Urban Development or the Secretary of Labor shall direct as a means of enforcing such provisions.

L. Davis Bacon-Wage Rates

(Insert applicable Davis-Bacon Wage Rates Here)

Required notice on lobbying:

Applicants/bidders for a lower tier covered transaction (except procurement contracts for good and services under \$25,000 not requiring the consent of a DOC official) are subject to 2 C.F.R. part 1326, subpart C, "Governmentwide Debarment and Suspension (Nonprocurement)." In addition, applicants/bidders for a lower tier covered transaction for a subaward, contract, or subcontract greater than \$100,000 of Federal funds at any tier are subject to 15 C.F.R. part 28, "New Restrictions on Lobbying."

Applicants/bidders should familiarize themselves with these provisions, including the certification requirement. Therefore, applications for a lower tier covered transaction must include a Form CD-512, "Certification Regarding Lobbying- Lower Tier Covered Transactions, "completed without modification.

Required Federal Equal Employment Opportunity clauses:

Standard Federal Equal Employment Opportunity Construction Contract Specifications (Executive Order 11246)

1. As used in these specifications:

a. "Covered area" means the geographical area described in the solicitation from which this contract resulted;

b. "Director" means Director, Office of Federal Contract Compliance Programs, United States Department of Labor, or any person to whom the Director delegates authority;

c. "Employer identification number" means the Federal Social Security number used on the Employer's Quarterly Federal Tax Return, U.S. Treasury Department Form 941.

d. "Minority" includes:

(i) Black (all persons having origins in any of the Black African racial groups not of Hispanic origin);

(ii) Hispanic (all persons of Mexican, Puerto Rican, Cuban, Central or South American or other Spanish Culture or origin, regardless of race);

(iii) Asian and Pacific Islander (all persons having origins in any of the original peoples of the Far East, Southeast Asia, the Indian Subcontinent, or the Pacific Islands); and

(iv) American Indian or Alaskan Native (all persons having origins in any of the original peoples of North America and maintaining identifiable tribal affiliations through membership and participation or community identification).

2. Whenever the Contractor, or any Subcontractor at any tier, subcontracts a portion of the work involving any construction trade, it shall physically include in each subcontract in excess of \$10,000 the provisions of these specifications and the Notice which contains the applicable goals for minority and female participation and which is set forth in the solicitations from which this contract resulted.

3. If the Contractor is participating (pursuant to 41 CFR 60-4.5) in a Hometown Plan approved by the U.S. Department of Labor in the covered area either individually or through an association, its affirmative action obligations on all work in the Plan area (including goals and timetables) shall be in accordance with that Plan for those trades which have unions participating in the Plan. Contractors must be able to demonstrate their participation in and compliance with the provisions of any such Hometown Plan. Each Contractor or Subcontractor participating in an approved Plan is individually required to comply with its obligations under the EEO clause, and to make a good faith effort to achieve each goal under the Plan in each trade in which it has employees. The overall good faith performance by other Contractors or Subcontractors toward a goal in an approved Plan does not excuse any covered Contractor's or Subcontractor's failure to take good faith efforts to achieve the Plan goals and timetables.

4. The Contractor shall implement the specific affirmative action standards provided in paragraphs 7 a through p of these specifications. The goals set forth in the solicitation from which this contract resulted are expressed as percentages of the total hours of employment and training of minority and female utilization the Contractor should reasonably be able to achieve in each construction trade in which it has employees in the covered area. Covered Construction contractors performing construction work in geographical areas where they do not have a Federal or federally assisted construction contract shall apply the minority and female goals established for the geographical area where the work is being performed. Goals are published periodically in the Federal Register in notice form, and such notices may be obtained from any Office of Federal Contract Compliance Programs office or from Federal procurement contracting officers. The Contractor is expected to make substantially uniform progress in meeting its goals in each craft during the period specified.

5. Neither the provisions of any collective bargaining agreement, nor the failure by a union with whom the Contractor has a collective bargaining agreement, to refer either minorities or women shall excuse the Contractor's obligations

under these specifications, Executive Order 11246, or the regulations promulgated pursuant thereto.

6. In order for the nonworking training hours of apprentices and trainees to be counted in meeting the goals, such apprentices and trainees must be employed by the Contractor during the training period, and the Contractor must have made a commitment to employ the apprentices and trainees at the completion of their training, subject to the availability of employment opportunities. Trainees must be trained pursuant to training programs approved by the U.S. Department of Labor.

7. The Contractor shall take specific affirmative actions to ensure equal employment opportunity. The evaluation of the Contractor's compliance with these specifications shall be based upon its effort to achieve maximum results from its actions. The Contractor shall document these efforts fully, and shall implement affirmative action steps at least as extensive as the following:

a. Ensure and maintain a working environment free of harassment, intimidation, and coercion at all sites, and in all facilities at which the Contractor's employees are assigned to work. The Contractor, where possible, will assign two or more women to each construction project. The Contractor shall specifically ensure that all foremen, superintendents, and other on-site supervisory personnel are aware of and carry out the Contractor's obligation to maintain such a working environment, with specific attention to minority or female individuals working at such sites or in such facilities.

b. Establish and maintain a current list of minority and female recruitment sources, provide written notification to minority and female recruitment sources and to community organizations when the Contractor or its unions have employment opportunities available, and maintain a record of the organizations' responses.

c. Maintain a current file of the names, addresses and telephone numbers of each minority and female off-the-street applicant and minority or female referral from a union, a recruitment source or community organization and of what action was taken with respect to each such individual. If such individual was sent to the union hiring hall for referral and was not referred back to the Contractor by the union or, if referred, not employed by the Contractor, this shall be documented in the file with the reason therefor, along with whatever additional actions the Contractor may have taken.

d. Provide immediate written notification to the Director when the union or unions with which the Contractor has a collective bargaining agreement has not referred to the Contractor a minority person or woman sent by the

Contractor, or when the Contractor has other information that the union referral process has impeded the Contractor's efforts to meet its obligations.

e. Develop on-the-job training opportunities and/or participate in training programs for the area which expressly include minorities and women, including upgrading programs and apprenticeship and trainee programs relevant to the Contractor's employment needs, especially those programs funded or approved by the Department of Labor. The Contractor shall provide notice of these programs to the sources compiled under 7b above.

f. Disseminate the Contractor's EEO policy by providing notice of the policy to unions and training programs and requesting their cooperation in assisting the Contractor in meeting its EEO obligations; by including it in any policy manual and collective bargaining agreement; by publicizing it in the company newspaper, annual report, etc.; by specific review of the policy with all management personnel and with all minority and female employees at least once a year; and by posting the company EEO policy on bulletin boards accessible to all employees at each location where construction work is performed.

g. Review, at least annually, the company's EEO policy and affirmative action obligations under these specifications with all employees having any responsibility for hiring, assignment, layoff, termination or other employment decisions including specific review of these items with onsite supervisory personnel such as Superintendents, General Foremen, etc., prior to the initiation of construction work at any job site. A written record shall be made and maintained identifying the time and place of these meetings, persons attending, subject matter discussed, and disposition of the subject matter.

h. Disseminate the Contractor's EEO policy externally by including it in any advertising in the news media, specifically including minority and female news media, and providing written notification to and discussing the Contractor's EEO policy with other Contractors and Subcontractors with whom the Contractor does or anticipates doing business.

i. Direct its recruitment efforts, both oral and written, to minority, female and community organizations, to schools with minority and female students and to minority and female recruitment and training organizations serving the Contractor's recruitment area and employment needs. Not later than one month prior to the date for the acceptance of applications for apprenticeship or other training by any recruitment source, the Contractor shall send written notification to organizations such as the above, describing the openings, screening procedures, and tests to be used in the selection process.

j. Encourage present minority and female employees to recruit other minority persons and women and, where reasonable, provide after school, summer and vacation employment to minority and female youth both on the site and in other areas of a Contractor's work force.

k. Validate all tests and other selection requirements where there is an obligation to do so under 41 CFR part 60-3.

l. Conduct, at least annually, an inventory and evaluation at least of all minority and female personnel for promotional opportunities and encourage these employees to seek or to prepare for, through appropriate training, etc., such opportunities.

m. Ensure that seniority practices, job classifications, work assignments and other personnel practices, do not have a discriminatory effect by continually monitoring all personnel and employment related activities to ensure that the EEO policy and the Contractor's obligations under these specifications are being carried out.

n. Ensure that all facilities and company activities are nonsegregated except that separate or single-user toilet and necessary changing facilities shall be provided to assure privacy between the sexes.

o. Document and maintain a record of all solicitations of offers for subcontracts from minority and female construction contractors and suppliers, including circulation of solicitations to minority and female contractor associations and other business associations.

p. Conduct a review, at least annually, of all supervisors' adherence to and performance under the Contractor's EEO policies and affirmative action obligations.

8. Contractors are encouraged to participate in voluntary associations which assist in fulfilling one or more of their affirmative action obligations (7a through p). The efforts of a contractor association, joint contractor-union, contractor-community, or other similar group of which the contractor is a member and participant, may be asserted as fulfilling any one or more of its obligations under 7a through p of these Specifications provided that the contractor actively participates in the group, makes every effort to assure that the group has a positive impact on the employment of minorities and women in the industry, ensures that the concrete benefits of the program are reflected in the Contractor's minority and female workforce participation, makes a good faith effort to meet its individual goals and timetables, and can provide access to documentation which demonstrates the effectiveness of actions taken on behalf of the Contractor. The obligation to comply, however, is the Contractor's and

failure of such a group to fulfill an obligation shall not be a defense for the Contractor's noncompliance.

9. A single goal for minorities and a separate single goal for women have been established. The Contractor, however, is required to provide equal employment opportunity and to take affirmative action for all minority groups, both male and female, and all women, both minority and non-minority. Consequently, the Contractor may be in violation of the Executive Order if a particular group is employed in a substantially disparate manner (for example, even though the Contractor has achieved its goals for women generally, the Contractor may be in violation of the Executive Order if a specific minority group of women is underutilized).

10. The Contractor shall not use the goals and timetables or affirmative action standards to discriminate against any person because of race, color, religion, sex, sexual orientation, gender identity, or national origin.

11. The Contractor shall not enter into any Subcontract with any person or firm debarred from Government contracts pursuant to Executive Order 11246.

12. The Contractor shall carry out such sanctions and penalties for violation of these specifications and of the Equal Opportunity Clause, including suspension, termination and cancellation of existing subcontracts as may be imposed or ordered pursuant to Executive Order 11246, as amended, and its implementing regulations, by the Office of Federal Contract Compliance Programs. Any Contractor who fails to carry out such sanctions and penalties shall be in violation of these specifications and Executive Order 11246, as amended.

13. The Contractor, in fulfilling its obligations under these specifications, shall implement specific affirmative action steps, at least as extensive as those standards prescribed in paragraph 7 of these specifications, so as to achieve maximum results from its efforts to ensure equal employment opportunity. If the Contractor fails to comply with the requirements of the Executive Order, the implementing regulations, or these specifications, the Director shall proceed in accordance with 41 CFR 60-4.8.

14. The Contractor shall designate a responsible official to monitor all employment related activity to ensure that the company EEO policy is being carried out, to submit reports relating to the provisions hereof as may be required by the Government and to keep records. Records shall at least include for each employee the name, address, telephone numbers, construction trade, union affiliation if any, employee identification number when assigned, social security number, race, sex, status (e.g., mechanic, apprentice trainee, helper, or laborer), dates of changes in status, hours worked per week in the indicated

trade, rate of pay, and locations at which the work was performed. Records shall be maintained in an easily understandable and retrievable form; however, to the degree that existing records satisfy this requirement, contractors shall not be required to maintain separate records.

15. Nothing herein provided shall be construed as a limitation upon the application of other laws which establish different standards of compliance or upon the application of requirements for the hiring of local or other area residents (e.g., those under the Public Works Employment Act of 1977 and the Community Development Block Grant Program).



ALABAMA DEPARTMENT OF REVENUE
 SALES AND USE TAX DIVISION
 P.O. Box 327710 • Montgomery, AL 36132-7710

ST: EXC-01
 6/14

Application For
 Sales and Use Tax Certificate of Exemption
 FOR GOVERNMENT ENTITY PROJECT

This Certificate of Exemption will be limited to purchases which qualify for an exemption of sales and use taxes pursuant to Rule No. 810-8-3-.77

PROJECT INFORMATION:

PROJECT NAME		PROJECT OWNER'S FEIN (EXEMPT ENTITY)	
STREET ADDRESS OF PROJECT (CITY AND COUNTY INCLUDED)	CITY	ZIP	COUNTY

APPLICANT'S INFORMATION:

RELATION: (CHOOSE ONE)		NAICS CODE	
<input type="checkbox"/> Exempt Entity	<input type="checkbox"/> General Contractor	<input type="checkbox"/> Sub-Contractor	
APPLICANT'S LEGAL NAME		FEIN	
DBA		CONSUMER'S USE TAX ACCOUNT NUMBER	
MAILING ADDRESS			
CONTACT PERSON		BUSINESS TELEPHONE NUMBER ()	
ESTIMATED START DATE		ESTIMATED COMPLETION DATE	
REASON EXEMPTION IS CLAIMED			
JOB DESCRIPTION			
WILL ANY POLLUTION CONTROL EXEMPTION BE APPLICABLE?		ESTIMATED POLLUTION CONTROL COST	
<input type="checkbox"/> Yes	<input type="checkbox"/> No	\$	
TOTAL BID AMOUNT	LABOR COST	MATERIAL COST	
\$	\$	\$	

PROJECT NAME	PROJECT OWNER'S FEIN (EXEMPT ENTITY)
--------------	--------------------------------------

FORM OF OWNERSHIP:

Individual
 Partnership
 Corporation
 Multi member LLC
 Single member LLC

If applicant is a corporation, a copy of the certified certificate of incorporation, amended certificate of incorporation, certificate of authority, or articles of incorporation should be attached. If the applicant is a limited liability company or a limited liability partnership, a copy of the certified articles of organization should be attached.

OWNERSHIP INFORMATION:

Corporations – give name, title, home address, and Social Security Number of each officer.

Partnerships – give name, home address, Social Security Number or FEIN of each partner.

Sole Proprietorships – give name, home address, Social Security Number of owner.

LLC – give name, home address, and Social Security Number or FEIN of each member.

LLP – give name, home address, and Social Security Number or FEIN of each partner.

NAME (PLEASE PRINT)	SIGNATURE
TITLE	DATE

REVENUE DEPARTMENT USE ONLY

Examiner's Remarks _____

Examiner _____ Date _____

Supervisor's Recommendation _____

Supervisor _____ Date _____

**Instructions For Preparation of Form ST: EXC-01
Sales and Use Tax Certificate of Exemption for Government Entity Project**

In order to expedite the processing of your application, please include the following documentation when submitting your application:

Exempt Entity:

1. Signed Application
2. Copy of Executed/Signed Contract and/or Letter of Intent

General Contractor:

1. Signed Application
2. Copy of Executed/Signed Contract and/or Letter of Intent
3. List of Sub-Contractors
4. Alabama Board of General Contractor's License
5. State/County Business License (usually obtained through county probate office)
6. Any other municipal business licenses associated with the project

Sub-Contractor:

1. Application
2. Alabama Board of General Contractor's License
3. State/County Business License (usually obtained through county probate office)
4. Any other municipal business licenses associated with the project
5. List of Sub-Contractors (if any)

General contractors and sub-contractors:

Any updates regarding the sub-contractors working on a project, additions and/or deletions, must be submitted to the Department within 30 days of occurrence.

If an extension is needed for a project, please contact the Department of Revenue at the address, numbers, or emails listed below.

THERE IS A FILING REQUIREMENT IF YOUR APPLICATION IS APPROVED. The return will be filed through the Consumer's Use Tax account. If you do not currently have a Consumer's Use Tax account, one will be opened for you. The return should be filed every filing period that the Contractor's Exemption Certificate is active/open and should include the Project No., Exemption No., and the total amount of purchases for the filing period. If there is no product purchased with the exemption certificate, then a zero return must be filed for the period. There is a requirement of one entry for each exemption certificate that is active for each filing period. The information associated with the Contractor's Exemption Certificates is input at the bottom of the return.

The application and applicable documentation may be mailed, faxed, or emailed to the following:

Fax: (334) 353-7867

Emails: amber.hartley@revenue.alabama.gov brenda.wallace@revenue.alabama.gov

Mailing Address: ATTN: Contractor's Exemption
Alabama Dept. of Revenue
Sales & Use Tax Division - Room 4303
PO Box 327710
Montgomery, AL 36132-7710

Exhibit A

THE CITY OF TUSCALOOSA MINORITY ENTERPRISE/DISADVANTAGED BUSINESS ENTERPRISE (MBE/DBE/WBE) POLICY FOR PUBLIC WORKS PROJECTS OVER \$50,000

General Mission Statement

THE CITY OF TUSCALOOSA (hereinafter, "City") has voluntarily adopted a Minority/Disadvantaged Business Enterprise (MBE/DBE/WBE) Program designed to encourage the participation and development of minority and disadvantaged business enterprises and to promote equal business opportunities in the City to the fullest extent allowed by state and federal law.

It is the intent of the City to foster competition among contractors, suppliers, and vendors that will result in better quality and more economical services rendered to the City. Under this policy, the City of Tuscaloosa has established a goal of ten to twenty percent (10-20%) inclusion of minority and disadvantaged business enterprise (hereinafter sometimes "MBE/DBE/WBE") for all services required to deliver City projects. In no case shall the stated percentage be the determining factor in contract awards. Rather, contractors must demonstrate a good faith effort to attain the desired percentage goal.

Program Goals

It is the goal of this program:

- To ensure non-discrimination in the award and administration of City contracts.
- To help to remove barriers to the participation of DBE/MBE/WBE's in competing for City contracts.
- To ensure a level playing field exists on which DBE/MBE/WBE's can compete fairly for City contracts.

Definition

1. "Minority Business Enterprise" ("MBE") means a business which is an independent and continuing enterprise for profit, performing a commercially useful function and is at least fifty-one percent (51%) owned and controlled by an African American, or Black American.

2. "Women-owned Business Enterprise" ("WBE") means a business which is an independent and continuing enterprise for profit, performing a commercially useful function and is at least fifty-one percent (51%) owned, operated and controlled on a daily basis by one or more female American citizens.

3. "Disadvantaged Business Enterprise" (DBE") means a business which is an independent and continuing enterprise for profit, performing a commercially useful function and is owned by a majority of persons who are United States citizens or permanent resident aliens (as defined by the Immigration and Naturalization Service) of the United States, and who are Asian, Black, Hispanic or Native Americans, according to the following definitions:

"Asian" – means persons having origins in any of the original people of the Far East, Southeast Asia, the Indian subcontinent, or the Pacific Islands.

"African American" or "Black American" means persons having origins in any black racial group of Africa.

"Hispanic" means persons of Spanish or Portuguese culture with origins in Mexico, South of Central America, or the Caribbean Islands regardless of race.

"Native American" means persons having origins in any of the original people of North America, including American Indians, Eskimos and Aleuts.

Equal Business Opportunity

It is the policy of the City to promote full and equal business opportunities for all persons doing business with the City, regardless of race, sex or national origin. It is the ultimate goal of this policy to promote an equitable business climate district. The City will seek to increase minority and women participation for contracts that require formal bids. These efforts will be for contracts above \$50,000 as allowed by the Alabama Public Works law. These efforts are designed to help prevent discrimination against minorities and disadvantaged businesses and promote more completion among vendors, suppliers, and contractors of the City of Tuscaloosa.

The City has established a goal of ten to twenty percent (10-20%) of the total construction related expenditures to be provided by minority and disadvantaged business enterprises. While the policy provides for voluntary participation by the City and is dependent upon race-neutral and gender-neutral considerations, contractors are encouraged to comply with the City's policy. The City of Tuscaloosa shall periodically review the policy, including race/gender-neutral remedies, to determine its effectiveness.

Good Faith Effect

The City require contractors to demonstrate a good faith effort to attain the goal of 10-20% participation of MBE/DBE/WBE's in all levels of the Public Works contracting process. Contractors shall document their efforts to obtain minority and disadvantaged business participation in the bid documents. Contractors should note that failure to document a good faith effort to the satisfaction of the City may subject the contractor to bid rejection for non-responsiveness.

The following process shall constitute a good faith effort under the City's policy:

(1) Contractors deciding to bid on a City project shall submit the MBE/DBE/WBE Documentation Statement and Acknowledgement (Form 1). Submission of Form 1 confirms the commitment of the contractor to participate in the inclusion effort for the project. Form 1 must be submitted to the City of Tuscaloosa Department of Infrastructure and Public Services and Innovation no later than seven (7) days prior to the bid, or at the pre-bid conference, whichever is earlier. The City reserves the right to modify the submittal deadline as-needed.

(2) Contractors shall submit MBE/DBE/WBE Bid Solicitation Notice (Form 2). Form 2 must be submitted to the City of Tuscaloosa Department of Infrastructure and Public Services no later than seven (7) days prior to the bid, or at the pre-bid conference, whichever is earlier. The City reserves the right to modify the submittal deadline as-needed.

(3) Contractors shall submit a brief plan for achieving the stated MBE/DBE/WBE Participation Goal for his/her trade (Form 3). Form 3 must be submitted in the contractor's sealed bid.

(4) Contractor shall submit a listing of all MBE/DBE/WBE contractors that submitted bids (**Form 4**). Form 4 must be submitted in the contractor's sealed bid. (Note: In the event a MBE/DBE/WBE contractor submits a bid after the general contractor has sealed the bid, contractors should write on the envelope the name(s) and scope of work of the MBE/DBE/WBE contractor who submitted the bid.)

(5) Contractors shall be required to work in cooperation with the City in the implementation of this program. Failure to do so, in the discretion of the City, may result in a rejection of bid due to non-responsiveness.

Following compliance with item (5) above, submission of Form 1, Form 2, Form 3, and Form 4 at the above-prescribed times shall satisfy the good faith effort requirement. Failure to do so may result in rejection of bid due to non-responsiveness.

Additional Administrative Requirements/Procedure

(1) Once a tentative contract award has been made, the successful contractor shall submit a list of all MBE/DBE/WBE firms the contractor proposes to utilize during the execution of the contract (**Form 5**). In addition, the contractor shall include on Form 5 all firms that the major subcontractors propose to utilize.

(2) If the successful contractor will be subcontracting less than the started percentage goal, the Contractor must complete a "MBE/DBE/WBE Unavailability Certification" (**Form 6**). Form 6 is due once a tentative contract award has been made.

(3) Contractors shall obtain the listing of certified MBE/DBE/WBE business by contacting the City of Tuscaloosa Department of Infrastructure and Public Services to assist in soliciting MBE/DBW/WBE participation for the project.

(4) Contractors shall not be required to use a MBE/DBE/WBE subcontractor who cannot display reasonable technical and financially qualifications to perform the work in question.

(5) In addition to the above requirements, contractors should note that the City reserves the right to periodically audit payroll records to ensure compliance with the program. The City employs the services of a Compliance Director.

(6) Upon completion of the project and prior to release of retainage or final payment, the contractor shall submit a Project Closeout Report (**Form 7**) that includes final accounting of all MBE/DBE/WBE firms utilized on the project.

(7) On a monthly basis, contractors shall submit updated MBE/DBE/WBE reports (Monthly Report Form) to identify any changes in MBE/DBE/WBE firm utilization (**Form 8**). Contractors shall submit Form 8 directly to the City of Tuscaloosa Department of Infrastructure and Public Services .

Race/Gender – Neutral Remedies

The City recognizes that race/gender – neutral remedies may be effective tools used to increase MBE/DBE/WBE participation. Therefore, the City will continue to explore these remedies. The remedies will include, but will not be limited to, the following:

1. Technical assistance techniques to identify and increase the participation of MBE/DBE/WBE's in the City's contracting, subcontracting and purchasing opportunities.
2. Continuation of the certification process.

The City will periodically review the success of these measures in order to determine the extent to which the measures provide equitable access to the City's contracting, subcontracting and purchasing opportunities.

The City has determined that this policy complies with all applicable local, state and national laws concerning the contracting and purchasing process. The City shall not sacrifice product quality for lower pricing, but shall make all awards in accordance with applicable law. It shall be the primary responsibility of the City to insure that this policy

is followed, and that all actions regarding the contracting and purchasing process comply with all applicable statutes as well as the defined goals relative to MBE/DBE/WBE participation on all construction projects.

Contact Information:

Savannah Howell
Director of Administration
Infrastructure and Public Services
City of Tuscaloosa
Phone: (205) 248-5712
showell@tuscaloosa.com

**Form 1 (one page)
Documentation Statement and Acknowledgement**

(Due no later than seven (7) days prior to the bid, or at the pre-bid
conference, whichever is earlier)

PROJECT NAME: The Edge

The City of Tuscaloosa has adopted a program to encourage the participation of Minority Business Enterprises/Disadvantaged Business Enterprises (MBE/DBE/WBE) on its public works construction projects. The signed statement serves as a commitment by the undersigned company to comply with this program as outlined by the City, relative to the involvement of MBE/DBE/WBE firm in City guidelines.

The undersigned Company will adhere to City program guidelines set forth to utilize MBE/DBE/WBE businesses in all construction projects, and all program forms (1-8) have been reviewed and understood.

Tyler Roberts
Company Representative (Signature)

3/8/12
Date

Tyler Roberts
Company Representative (Printed)

Project Manager
Title

Turner Plumbing
Company Name

(205) 345-4825
Telephone Number

Tuscaloosa AL, 35401
City, State, Zip

Fax Number

Form 2 (6 pages)
Bid Solicitation Notice

(Due no later than seven (7) days prior to the bid, or at the pre-bid
Conference, whichever is earlier)

BID DATA

1. GENERAL CONTRACTOR: Turner Plumbing
ADDRESS: 1700 26th Avenue
- CONTACT (S): Tyler Roberts
PHONE: 205-345-4825
FAX: 205-345-4826
E-MAIL: Roberts@turnerplumbinginc.net
2. OWNER: Ricky Turner
3. NAME OF PROJECT: The Edge
4. SCHEDULE PRE-BID MEETING
DATE/TIME: 3/8/17
LOCATION: City Hall
5. DATE/TIME FOR RECEIPT OF BIDS: 3/23
6. SCHEDULE BID OPENING
DATE/TIME: City Hall / 2:00 3/23
LOCATION: Cornell Chamber
7. ESTIMATED JOB START DATE: April 2017
8. ESTIMATED COMPLETION DATE: January 2018

- DIVISION 6 - OPENINGS (1) (2) (3) (4) (5)**
- 06 11 METAL DOORS & FRAMES
 - 06 12 METAL FRAMES
 - 06 13 METAL DOORS
 - 06 14 WOOD DOORS
 - 06 16 COMPOSITE DOORS
 - 06 17 INTEGRATED DOOR OPENING ASSEMBLIES
 - 06 31 ACCESS DOORS & PANELS
 - 06 32 SLIDING GLASS DOORS
 - 06 33 COLLING DOORS & GRILLES
 - 06 34 SPECIAL FUNCTION DOORS
 - 06 36 PANEL DOORS
 - 06 38 TRAFFIC DOORS
 - 06 41 ENTRANCES & STOREFRONTS
 - 06 42 ENTRANCES
 - 06 43 STOREFRONTS
 - 06 44 CURTAIN WALL & GLAZED ASSEMBLIES
 - 06 61 METAL WINDOWS
 - 06 62 WOOD WINDOWS
 - 06 63 PLASTIC WINDOWS
 - 06 64 COMPOSITE WINDOWS
 - 06 65 SPECIAL FUNCTION WINDOWS
 - 06 66 UNIT SKYLIGHTS
 - 06 67 METAL-FRAMED SKYLIGHTS
 - 06 71 DOOR HARDWARE
 - 06 74 ACCESS CONTROL HARDWARE
 - 06 75 WINDOW HARDWARE
 - 06 76 WINDOW HARDWARE ACCESSORIES
 - 06 77 GLASS GLAZING
 - 06 83 MIRRORS
 - 06 84 PLASTIC GLAZING
 - 06 88 SPECIAL FUNCTION GLAZING
 - 06 91 LOUVERS
 - 06 93 VENTS
- (Please fill-in for other opportunity)
- DIVISION 9 - FINISHES (1) (2) (3) (4) (5)**
- 09 21 PLASTER & GYPSUM ASSEMBLIES
 - 09 22 SUPPORTS FOR PLASTER & GYPSUM
 - 09 23 GYPSUM PLASTERING
 - 09 24 CEMENT PLASTERING
 - 09 26 VENEER PLASTERING
 - 09 28 BACKING & UNDERLAYMENTS
 - 09 29 GYPSUM
 - 09 30 TILING
 - 09 61 ACOUSTICAL CEILINGS
 - 09 64 SPECIALTY CEILINGS
 - 09 62 SPECIALTY FLOORING
 - 09 63 MASONRY FLOORING
 - 09 64 WOOD FLOORING

- DIVISION 7 - THERMAL & MOISTURE PROTECTION**
- (Please fill-in for other opportunity)
- 06 12 STRUCTURAL PANELS
 - 06 15 WOOD DECKING
 - 06 16 SHEATHING
 - 06 17 SHOT FABRICATED STRUCTURAL WOOD
 - 06 22 MILLWORK
 - 06 25 PREFINISHED PANEL
 - 06 26 PANELING
 - 06 43 WOOD STAIRS & RAILINGS
 - 06 44 ORNAMENTAL WOODWORK
 - 06 45 WOOD FRAMES
- DIVISION 7 - THERMAL & MOISTURE PROTECTION**
- (Please fill-in for other opportunity)
- 07 11 DAMPROOFING
 - 07 12 BUILT-UP BITUMINOUS WATERPROOFING
 - 07 13 SHEET WATERPROOFING
 - 07 16 CEMENTIOUS & REACTIVE WATERPROOFING
 - 07 19 WATER REPELLANTS
 - 07 21 THERMAL INSULATION
 - 07 22 ROOF & DECK INSULATION
 - 07 24 EXTERIOR INSULATION & FINISH SYSTEMS
 - 07 25 WEATHER BARRIERS
 - 07 26 VAPOR RETARDERS
 - 07 31 SHINGLES & SHAPES
 - 07 32 NATURAL ROOF COVERINGS
 - 07 33 ROOF PANELS
 - 07 41 ROOF PANELS
 - 07 42 WALL PANELS
 - 07 46 SIDING
 - 07 61 BUILT-UP BITUMINOUS ROOFING
 - 07 62 MODIFIED BITUMINOUS MEMBRANE ROOFING
 - 07 63 ELASTOMERIC MEMBRANE ROOFING
 - 07 64 THERMOPLASTIC MEMBRANE ROOFING
 - 07 65 FLUID APPLIED ROOFING
 - 07 66 ROLL ROOFING
 - 07 67 SHEET METAL ROOFING
 - 07 69 FLEXIBLE FLASHING
 - 07 71 ROOF SPECIALTIES
 - 07 72 ROOF ACCESSORIES
 - 07 81 APPLIED FURFLOORING
 - 07 84 FIRESTOPPING
 - 07 91 PREFORMED JOINT SEALS
 - 07 92 JOINT SEALANTS
 - 07 93 EXPANSION CONTROL
- (Please fill-in for other opportunity)

- 09 65 RESURFACING FLOORING
 - 09 66 TERRAZZO FLOORING
 - 09 68 CARPETING
 - 09 72 WALL COVERINGS
 - 09 77 SPECIAL WALL SURFACING
 - 09 81 PAINTING
 - 09 93 STAINING & TRANSPARENT FINISHING
 - 09 98 HIGH PERFORMANCE COATINGS
 - 09 97 SPECIAL COATINGS
 - 09
- (Please fill-in for other opportunity)
- 10 11 VISUAL DISPLAY UNITS
 - 10 14 SIGNAGE
 - 10 22 PARTITIONS
 - 10 26 WALL & DOOR PROTECTION
 - 10 28 TONER, BATH & LAUNDRY ACCESSORIES
 - 10 44 FIRE PROTECTION SPECIALTIES
 - 10 51 LOCKERS
 - 10 71 EXTERIOR PROTECTION
 - 10 74 MANUFACTURED EXTERIOR SPECIALTIES
 - 10 76 FLAGPOLES
 - 10 81 PEST CONTROL DEVICES
 - 10 88 SCALES
 - 10
- (Please fill-in for other opportunity)
- 11 24 MAINTENANCE EQUIPMENT
 - 11 31 RESIDENTIAL APPLIANCES
 - 11 33 RETRACTABLE STAIRS
 - 11 41 FOODSERVICE STORAGE EQUIPMENT
 - 11 42 FOOD PREPARATION EQUIPMENT
 - 11 43 FOOD DELIVERY CARTS AND CONVEYORS
 - 11 44 FOOD COOKING EQUIPMENT
 - 11 46 FOOD DISPENSING EQUIPMENT
 - 11 47 ICE MACHINES
 - 11 48 CLEANING & DISPOSAL EQUIPMENT
 - 11 52 AUDIO-VISUAL EQUIPMENT
 - 11 53 LABORATORY EQUIPMENT
 - 11 59 ATHLETIC EQUIPMENT
 - 11 67 RECREATIONAL EQUIPMENT
 - 11 62 SOLID WASTE HANDLING
- (Please fill-in for other opportunity)

- 14 11 MANUAL DUMPSWATERS
 - 14 12 ELECTRIC DUMPSWATERS
 - 14 21 ELECTRIC TRACTION ELEVATORS
 - 14 24 HYDRAULIC ELEVATORS
 - 14 27 CUSTOM ELEVATOR CABS & DOORS
 - 14 28 ELEVATOR EQUIPMENT & CONTROLS
 - 14 31 ESCALATORS
- (5)
- DIVISION 14 - CONVEYING SYSTEMS (1) (2) (3) (4)
- (Please fill-in for other opportunity)
- 13 21 CONTROLLED ENVIRONMENT ROOMS
 - 13 24 SPECIAL ACTIVITY ROOMS
 - 13 28 ATHLETIC & RECREATIONAL SPECIAL CONSTRUCTION
 - 13 31 FABRIC STRUCTURES
 - 13 34 FABRICATED ENGINEERED STRUCTURES
 - 13 36 TOWERS
 - 13 42 BUILDING MODULES
 - 13 48 SOUND, VIBRATION, & SEISMIC CONTROL
 - 13 49 RADIATION PROTECTION
 - 13
- (Please fill-in for other opportunity)
- DIVISION 13 - SPECIAL CONSTRUCTION (1) (2) (3) (4) (5)
- 12 21 CONTROLLED ENVIRONMENT ROOMS
 - 12 24 SPECIAL ACTIVITY ROOMS
 - 12 28 ATHLETIC & RECREATIONAL SPECIAL CONSTRUCTION
 - 12 31 FABRIC STRUCTURES
 - 12 34 FABRICATED ENGINEERED STRUCTURES
 - 12 36 TOWERS
 - 12 42 BUILDING MODULES
 - 12 48 SOUND, VIBRATION, & SEISMIC CONTROL
 - 12 49 RADIATION PROTECTION
 - 12
- (Please fill-in for other opportunity)
- DIVISION 12 - FURNISHINGS (1) (2) (3) (4) (5)
- 12 21 WINDOW BLINDS
 - 12 22 CURTAINS & DRAPES
 - 12 23 INTERIOR SHUTTERS
 - 12 24 WINDOW SHADES
 - 12 22 MANUFACTURED CASEWORK
 - 12 35 SPECIALTY CASEWORK
 - 12 36 COUNTERTOPS
 - 12 46 FURNISHING ACCESSORIES
 - 12 48 RUGS & MATS
 - 12 61 OFFICE FURNITURE
 - 12 62 SEATING
 - 12 64 HOSPITALITY FURNITURE
 - 12 66 INSTITUTIONAL FURNITURE
 - 12 61 FIXED AUDIENCE SEATING
 - 12 63 STADIUM & ARENA SEATING
 - 12 67 PENS & BENCHES
 - 12 82 INTERIOR PLANTERS & ARTIFICIAL PLANTS
 - 12 83 SITE FURNISHINGS
 - 12

- 23 41 PARTICULATE AIR FILTRATION
- 23 52 HEATING BOILERS
- 23 54 FURNACES
- 23 56 SOLAR ENERGY HEATING EQUIP.
- 23 57 HEAT EXCHANGERS FOR HVAC
- 23 58 SOLAR ENERGY HEATING EQUIP.
- 23 59 REFRIGERANT CONDENSORS
- 23 63 REFRIGERANT CONDENSORS
- 23 64 PACKAGED WATER CHILLERS
- 23 65 COOLING TOWERS
- 23 73 INDOOR CENTRAL-STATION AIR-HANDLING UNITS
- 23 74 PACKAGED OUTDOOR HVAC EQUIP.
- 23 82 CONVECTION HEATING & COOLING UNITS
- 23 84 HUMIDITY CONTROL EQUIPMENT
- 23 (Please fill-in for other opportunity)
- 26 09 INSTRUMENTATION & CONTROL FOR ELECTRICAL SYSTEMS
- 26 12 MEDIUM VOLTAGE TRANSFORMERS
- 26 22 LOW VOLTAGE TRANSFORMERS
- 26 24 SWITCHES & PANELS
- 26 25 ENCLOSED BUS ASSEMBLIES
- 26 27 LOW VOLTAGE DISTRIBUTION EQUIPMENT
- 26 28 LOW VOLTAGE CIRCUIT PROTECTIVE DEVICES
- 26 29 LOW VOLTAGE CONTROLLERS
- 26 32 PACKAGED GENERATOR ASSEMBLIES
- 26 35 POWER FILTERS & CONDITIONERS
- 26 42 CATHODIC PROTECTION
- 26 51 INTERIOR LIGHTING
- 26 52 EMERGENCY LIGHTING
- 26 53 EXIT SIGNS
- 26 54 CLASSIFIED LOCATION LIGHTING
- 26 55 SPECIAL PURPOSE LIGHTING
- 26 56 EXTERIOR LIGHTING
- 26 81 LIGHTING SYSTEMS & ACCESSORIES
- 26 71 ELECTRICAL MACHINES
- 28 (Please fill-in for other opportunity)
- 27 41 AUDIO-VIDEO SYSTEMS
- 27 41 AUDIO-VIDEO SYSTEMS
- 27 51 DISTRIBUTED AUDIO VIDEO COMMUNICATIONS & MONITORING SYSTEMS
- 27 52 HEALTHCARE COMMUNICATIONS & MONITORING SYSTEMS
- 27 53 DISTRIBUTED SYSTEMS

- 14 32 MOVING WALKS
- 14 42 WHEELCHAIR LIFTS
- 14 51 CORRESPONDENCE & PARCEL LIFTS
- 14 51 FACILITY CHUTES
- 14 52 PNEUMATIC TUBE SYSTEMS
- 14 (Please fill-in for other opportunity)
- 21 11 FIRE-SUPPRESSION WATER SERVICE PIPING METHODS
- 21 12 FIRE SUPPRESSION STANDPES
- 21 13 FIRE SUPPRESSION SPRINKLER SYSTEMS
- 21 21 CARBON-DIOXIDE FIRE EXTINGUISHING SYSTEMS
- 21 22 CLEAN AGENT FIRE EXTINGUISHING SYSTEMS
- 21 31 CENTRAL FIRE PUMPS
- 21 (Please fill-in for other opportunity)
- 22 07 PLUMBING INSULATION
- 22 11 FACILITY WATER DISTRIBUTION
- 22 13 FACILITY SANITARY SEWERAGE
- 22 14 FACILITY STORM DRAINAGE
- 22 41 COMMERCIAL PLUMBING FIXTURE
- 22 42 COMMERCIAL PLUMBING FIXTURES
- 22 45 EMERGENCY PLUMBING FIXTURES
- 22 47 DRINKING FOUNTAINS & WATER COOLERS
- 22 51 SWIMMING POOL PLUMBING SYSTEMS
- 22 56 CHEMICAL WASTE SYSTEMS FOR LAB & HEALTHCARE FACILITIES
- 22 (Please fill-in for other opportunity)
- 22 HEATING VENTILATION AIR CONDITIONING (1) (2) (3) (4) (5)
- 23 07 HVAC INSULATION & CONTROL FOR HVAC
- 23 13 FACILITY FUEL-STORAGE TANKS
- 23 21 HYDROIC PIPING & PUMPS
- 23 22 STEAM & CONDENSATE PIPING & PUMPS
- 23 31 HVAC DUCTS & CASINGS
- 23 33 AIR DUCT ACCESSORIES
- 23 34 HVAC FANS
- 23 37 AIR OUTLETS & INLETS
- 23 38 VENTILATION HOODS

27 _____
(Please fill-in for other opportunity)

ELECTRONIC SAFETY & SECURITY- 28 (1) (2) (3) (4) (5)

28 13 COMMUNICATIONS BACKBONE CABLING

28 16 INTRUSION DETECTION

28 23 VIDEO SURVEILLANCE

28 31 FIRE DETECTION

28 33 FUEL-GAS DETECTION

28 39 MASS NOTIFICATION SYSTEMS

28 _____
(Please fill-in for other opportunity)

EARTHWORK-31 (1) (2) (3) (4) (5)

31 06 SCHEDULES FOR EARTHWORK

31 11 CLEARING & GRUBBING

31 13 SELECTIVE TREE & SHRUB REMOVAL & TRIMMING

31 14 EARTH STRIPPING & STOCKPILING

31 22 GRADING

31 23 EXCAVATION & FILL

31 25 EROSION & SEDIMENTATION

31 31 SOIL TREATMENT

31 32 SOIL STABILIZATION

31 33 ROCK STABILIZATION

31 36 GABIONS

31 37 RIPRAP

31 41 SHORING

31 43 CONCRETE RAISING

31 45 VIBROFLORATION & DENSIFICATION

31 46 NEEDLE BEAMS

31 48 UNDERPINNING

31 52 COPPERDAMS

31 58 SHURRY WALLS

31 62 DRIVEN PILES

31 63 BORED PILES

31 _____
(Please fill-in for other opportunity)

EXTERIOR IMPROVEMENTS- 32 (1) (2) (3) (4) (5)

32 11 BASE COURSES

32 12 FLEXIBLE PAVING

32 13 RIGID PAVING

32 16 CURBS, GUTTERS SIDEWALKS & DRIVEWAYS

32 17 PAVING SPECIALTIES

32 18 ATHLETIC & RECREATIONAL SURFACING

32 31 FENCES & GATES

32 32 RETAINING WALLS

32 34 FABRICATED BRIDGES

32 35 SCREENING DEVICES

32 84 PLANTING IRRIGATION

32 91 PLANTING PREPARATION

32 92 TURF & GRASSES

32 93 PLANTS

32 94 PLANTING ACCESSORIES

32 96 TRANSPLANTING

32 _____

(Please fill-in for other opportunity)

UTILITIES-33 (1) (2) (3) (4) (5)

33 11 WATER UTILITY DISTRIBUTION PIPING

33 12 WATER UTILITY DISTRIBUTION EQUIPMENT

33 16 WATER UTILITY STORAGE TANKS

33 21 WATER SUPPLY WELLS

33 31 SANITARY UTILITY SEWERAGE PIPING

33 36 UTILITY SEPTIC TANKS

33 41 STORM UTILITY DRAINAGE PIPING

33 42 CULVERTS

33 44 STORM UTILITY WATER DRAINS

33 46 SUBDRAINAGE

33 48 STORM DRAINAGE STRUCTURES

33 51 NATURAL GAS DISTRIBUTION

33 52 LIQUID FUEL DISTRIBUTION

33 71 ELECTRICAL UTILITY TRANSMISSION & DISTRIBUTION

33 81 COMMUNICATIONS & STRUCTURES

33 _____

(Please fill-in for other opportunity)

TRANSPORTATION-34 (1) (2) (3) (4) (5)

34 11 RAIL TRACKS

34 41 ROADWAY SIGNALING AND CONTROL EQUIPMENT

34 71 ROADWAY CONSTRUCTION

34 72 RAILWAY CONSTRUCTION

34 _____

(Please fill-in for other opportunity)

MATERIAL PROCESSING & HANDLING EQUIPMENT-41 (1) (2) (3) (4) (5)

41 21 CONVEYORS

41 22 CRANES & HOISTS

41 _____

(Please fill-in for other opportunity)

POLLUTION CONTROL EQUIP-44 (1) (2) (3) (4) (5)

44 11 PARTICULATE CONTROL EQUIPMENT

44 _____

(Please fill-in for other opportunity)

WATER & WASTEWATER EQUIPMENT-46 (1) (2) (3) (4) (5)

46 07 PACKAGED WATER & WASTEWATER TREATMENT EQUIPMENT

46 _____

(Please fill-in for other opportunity)

**Form 4
Contractors Submitting Bids
(Must be submitted in the contractor's sealed bid)**

General Contractor: Turner Plumbing, Inc. (Plumbing Trade Contractor)

Contact: Ricky Turner

Name of Project: THE EDGE Business Resource Center

Date Submitted: March 30, 2017

All MBE/DBE/WBE Firms Submitting Bids

Crimson Insulation

Scope of Work

Insulation of plumbing piping

**FORM 5
CONTRACTORS SUBMITTING BIDS
(Must be submitted following tentative bid award)**

General Contractor: _____

Contact: _____

Name of Project: _____

Total Contract Amount: \$ _____

Total Amount of All Subcontractors: \$ _____

Date Submitted: _____

All MBE/DBE/WBE firms to be utilized

Scope of Work

Contract Amount

(Use additional pages if necessary)

**Form 6
Unavailability Certification
(Must be submitted following tentative bid award)**

I, _____ (Name/Title), of _____ (Company) certify that on _____ (Date) I contacted the following Minority/Disadvantaged Business Enterprise to obtain proposals/bids for the following work items:

<u>MDE/DBE/WBE Firm</u>	<u>Work Items Sought</u>	<u>Form of Proposal Sought</u>
_____	_____	_____
_____	_____	_____
_____	_____	_____
_____	_____	_____
_____	_____	_____

To the best of my knowledge and belief, said Minority/Disadvantaged Business Enterprises were unavailable for work on this project, or unable to prepare a proposal/bid for the following reason(s): _____

(This form to be completed by each MBE/DBE/WBE listed, which was contacted, but did not submit a bid/proposal)

_____ (Name of MBE/DBE/WBE) was offered an opportunity to submit a proposal on the above identified work on _____ (Date) by _____ (Company Name).

The above statement is a true and accurate account of why I did not submit a proposal/bid on this project.

_____ (Signature of MBE/DBE/WBE)
 _____ (Date)
 _____ (Title)

(Use additional pages if necessary)

Form 7
Project Closeout Report
 (To be submitted upon completion of project)

General Contractor: _____
 Contact: _____
 Name of Project: _____
 Total Contract Amount: \$ _____
 Final Contract Amount: \$ _____
 Date Submitted: _____

<u>All MBE/DBE/WBE firms verified</u>	<u>Original subcontract amount</u>	<u>Final subcontract amount</u>
_____	_____	_____
_____	_____	_____
_____	_____	_____
_____	_____	_____

Form 8
Monthly Report Form
 (To be submitted monthly directly to the City's consultant)

General Contractor: _____
 Contact: _____
 Name of Project: _____
 Total Contract Amount: \$ _____
 Date Submitted: _____

Billings

Each MBE/DBE/WBE Contractor utilized	Original subcontract amount	Previous amount	This period amount	Total Amount

(Use additional pages if necessary)

Preconstruction Conference Requirements

The Economic Development Administration (EDA) requires certain items be covered during the preconstruction conferences following award of construction contracts to ensure Award Recipients, Project Development Team Members, and Construction Contractors/subcontractors are aware of Federal requirements set forth under the terms and conditions of the Grant Award.

The following items should be discussed at the Preconstruction Conference concerning Federal requirements that must be met due to the project being financed through the use of Federal funds:

INFORMATION FOR CONTRACTORS AND SUBCONTRACTORS

Contractor Verification. Contractor(s) have certified that they have not been debarred from any Federal contract work and have executed a certification of eligibility. Contractors will include certifications of eligibility in contracts with subcontractors. It is the contractor's responsibility to insure that ineligible subcontractors not work on this project.

Davis Bacon. Davis Bacon rates are for construction only and are not applicable to suppliers. Construction workers (contractors and subcontractors) must be paid Davis Bacon rates. A copy of the rates and federal wage posters are to be posted at the job site. The Contractor will put up posters, wage rates, etc. at a bulletin board located at its office.

Davis Bacon also requires that time and a half be paid for to an employee for work exceeding 40 hours per week. WORKERS ARE ABLE TO WORK OVER 8 HOURS A DAY WITHOUT TIME AND A HALF BEING PAID. The contractor and subcontractor(s) must submit weekly payrolls to the Owner within 7 workdays of the last date of the respective workweek. It is the contractor's responsibility to insure that all payrolls are completed and submitted to the Owner. If payroll deficiencies occur, the contractor will be given a list of deficiencies, which must be corrected within 30 days. Final payment will not be made until all deficiencies are resolved.

Payroll Forms. Contractors and subcontractors must weekly submit payroll forms that have information contained on the attached standard Federal payroll form - Form WH-347. If you use your own form it is requested that the attached "Copeland Kick-Back" statement be completed, signed and attached to each payroll. The contractor and subcontractor(s) must execute and submit a "CERTIFICATE FROM CONTRACTOR APPOINTING OFFICER OR EMPLOYEE TO SUPERVISE PAYMENT OF EMPLOYEES". Each week contractor(s) will submit with their payroll a list of subcontractors that worked on the job (during the reporting week).

If a contractor or subcontractor does not work during a week, a payroll for the week should be submitted with "NO WQRK PERFORMED DURING THE WEEK" typed on the first page. At the completion of a contract- the contractor's or subcontractor(s)' last payroll should be marked "FINAL PAYROLL". Visit the U. S. Department of Labor's website: <http://www.dol.gov/whd/regs/compliance/posters/davis.htm> for required Davis-Bacon Posters that every employer performing work covered by the labor standards of The Davis-Bacon and Related Acts shall post a notice (including any applicable wage determination) at

the site of the work in a prominent and accessible place where it may be easily seen by employees; and website: <http://www.dol.gov/whd/forms/wh347instr.htm> for the instructions for completing Payroll Form, WH-347. Form WH-347 has been made available for the convenience of contractors and subcontractors required by their Federal or Federally-aided construction-type contracts and subcontracts to submit weekly payrolls. Properly filled out, form wh-347 will satisfy the requirements of Regulations, Parts 3 and 5 (29 C.F.R., Subtitle A), as to payrolls submitted in connection with contracts subject to the Davis-Bacon and related Acts. Although Regulations at 29 C.F.R. Part 5.5(a)(3)(ii) require contractors to submit weekly a copy of all payrolls to the Federal agency contracting for or financing the construction project, accompanied by a signed "Statement of Compliance", EDA has elected to require the Award Recipients to maintain these records (weekly payrolls) at its principal office to allow access by EDA, the Comptroller General of the United States, the Inspector General of the Department of Commerce or other duly authorized representatives to any documents, books, papers, and records of the ENGINEER for the purpose of making an audit, examination, excerpts, and transcriptions.

The contractor, subcontractor(s) will provide a work description of any person(s) who they feel are exempt from Davis Bacon requirements such as "working supervisors" and bona-fide "self-employed" contractors.

If apprentices are used, they MUST be registered with the State's Department of Labor apprenticeship program.

Be sure that a worker's classification meets Davis Bacon classification. Example: There may be more than one classification of laborer. Also, if a worker performs duties in more than one classification, he or she must be paid at least the applicable rate for each classification. Time sheets must indicate how much the person worked in each classification. It is usually simpler to classify the worker in the higher wage classification and pay the higher wage for all work.

The CERTIFICATE FROM CONTRACTOR APPOINTING OFFICER OR EMPLOYEE TO SUPERVISE PAYMENT OF EMPLOYEES form, weekly payroll forms including listing of subcontractors are to be sent to ATT: Grant Administrator.

Employee Interviews. During the course of construction the Owner will have a representative to interview contractor and subcontractor employees. The purpose of interviewing is to insure that Davis Bacon wage rates/overtime is being paid. These interviews are a Federal requirement.

Contractor's notice to Subcontractor's concerning Equal Opportunity clause and other Federal construction clauses. The contractor will send a notice to subcontractors that where the subcontract exceeds \$10,000 that they are not exempt from the provisions of the Equal Opportunity clause.

CONTRACT PAYMENT REQUESTS/SALES TAX: The Award Recipient must review and approve contractor and subcontractor requests for payment, which will be made on an "APPLICATION FOR PAYMENT" AIA Document G702 or its equivalent. Requests for payments will be submitted to the project engineer for review who will certify that all construction for which reimbursement is claimed has been completed and all material and equipment for which reimbursement is claimed has been delivered to the site.

Monthly sales tax (State/Local) reports including subcontractors, machinery/equipment, etc. should be included with each payment request.

CONTRACT CHANGE ORDERS: If change orders occur they must be recommended by THE PROJECT ENGINEER and approved by the Award Recipient and the Economic Development Administration (Milton Cochran -EDA Public Works). The Change Order Form contained in the bid packet must be used.

INSURANCE: Prime contractor and subcontractor(s) must maintain during the life of the respective contracts: Workmen's Compensation Insurance; Public Liability and Property Damage Insurance; and Vehicular Insurance. The contractor shall furnish the Owner with certificates showing the type, amount, class of operations covered, effective dates and dates of expiration of policies.

SAFETY: Contractors and subcontractors are obligated to meet OSHA regulations. The General Conditions require compliance with the Construction Safety Act. The contractor must provide for: 1.) means for assuring that all workers have or are provided with knowledge of how to do their job safely; 2.) means of keeping the job in a state of good housekeeping; 3.) free and easy access to and around the job; 4.) sufficient fire protection facilities including water supply; 5.) methods of controlling temporary heaters; 6.) safe operations around power lines; 7.) ample protection and safety equipment; and 8.) report accidents to the Award Recipient. Compliance with Federal, State, and local regulations is required under the terms of the contract. The handling and storage of explosives, operation of steam boilers, operation of cranes in the vicinity of power lines, etc. normally require State permits and inspection - this is the responsibility of the contractor.

EDA PROJECT SIGN: The Contractor shall construct a project sign in accordance with the EDA's Project Site Sign Specifications found in the EDA Post Award Construction Process Instructional CD.

NOTE ON SUBCONTRACTS: The Contractor shall ensure subcontracts comply to the same "Award Conditions". Also Davis Bacon wage requirements are applicable to all construction contracts that exceed \$2,500.

U.S. Department of Labor
Wage and Hour Division

PAYROLL

(For Contractor's Optional Use; See Instructions at www.dol.gov/whd/forms/wh347Instr.htm)



U.S. Wage and Hour Division

Rev. Dec. 2008

Persons are not required to respond to the collection of information unless it displays a currently valid OMB control number.

OMB No.: 1235-0008
Expires: 01/31/2015

NAME OF CONTRACTOR <input type="checkbox"/> OR SUBCONTRACTOR <input type="checkbox"/>	ADDRESS	
PAYROLL NO.	FOR WEEK ENDING	PROJECT AND LOCATION
		PROJECT OR CONTRACT NO.

(1) NAME AND INDIVIDUAL IDENTIFYING NUMBER (e.g., LAST FOUR DIGITS OF SOCIAL SECURITY NUMBER) OF WORKER	(2) NO. OF WITHHOLDING EXEMPTIONS	(3) WORK CLASSIFICATION	OT OR ST.	(4) DAY AND DATE							(5) TOTAL HOURS	(6) RATE OF PAY	(7) GROSS AMOUNT EARNED	(8) DEDUCTIONS					(9) NET WAGES PAID FOR WEEK
				HOURS WORKED EACH DAY										FICA	WITH- HOLDING TAX	OTHER	TOTAL DEDUCTIONS		
			O																
			S																
			O																
			S																
			O																
			S																
			O																
			S																
			O																
			S																
			O																
			S																

While completion of Form WH-347 is optional, it is mandatory for covered contractors and subcontractors performing work on Federally financed or assisted construction contracts to respond to the information collection contained in 29 C.F.R. §§ 3.3, 5.6(a). The Copeland Act (40 U.S.C. § 3145) contractors and subcontractors performing work on Federally financed or assisted construction contracts to "furnish weekly a statement with respect to the wages paid each employee during the preceding week." U.S. Department of Labor (DOL) regulations at 29 C.F.R. § 5.6(a)(3)(i) require contractors to submit weekly a copy of all payrolls to the Federal agency contracting for or financing the construction project, accompanied by a signed "Statement of Compliance" indicating that the payrolls are correct and complete and that each laborer or mechanic has been paid not less than the proper Davis-Bacon prevailing wage rate for the work performed. DOL and federal contracting agencies receiving this information review the information to determine that employees have received legally required wages and fringe benefits.

Public Burden Statement

We estimate that it will take an average of 55 minutes to complete this collection, including time for reviewing instructions, searching existing data sources, gathering and maintaining the data needed, and completing and reviewing the collection of information. If you have any comments regarding these estimates or any other aspect of this collection, including suggestions for reducing this burden, send them to the Administrator, Wage and Hour Division, U.S. Department of Labor, Room S3502, 200 Constitution Avenue, N.W., Washington, D.C. 20210

EXHIBIT C

Date _____

I, _____
(Name of Signatory Party) (Title)

do hereby state:

(1) That I pay or supervise the payment of the persons employed by

_____ on the
(Contractor or Subcontractor)
_____ ; that during the payroll period commencing on the
(Building or Work)
_____ day of _____, _____, and ending the _____ day of _____, _____,
all persons employed on said project have been paid the full weekly wages earned, that no rebates have
been or will be made either directly or indirectly to or on behalf of said

_____ from the full
(Contractor or Subcontractor)
weekly wages earned by any person and that no deductions have been made either directly or indirectly
from the full wages earned by any person, other than permissible deductions as defined in Regulations, Part
3 (28 C.F.R. Subtitle A), issued by the Secretary of Labor under the Copeland Act, as amended (48 Stat. 948,
63 Stat. 108, 72 Stat. 967; 76 Stat. 357; 40 U.S.C. § 3145), and described below:

(2) That any payrolls otherwise under this contract required to be submitted for the above period are
correct and complete; that the wage rates for laborers or mechanics contained therein are not less than the
applicable wage rates contained in any wage determination incorporated into the contract; that the classifications
set forth therein for each laborer or mechanic conform with the work he performed.

(3) That any apprentices employed in the above period are duly registered in a bona fide apprenticeship
program registered with a State apprenticeship agency recognized by the Bureau of Apprenticeship and
Training, United States Department of Labor, or if no such recognized agency exists in a State, are registered
with the Bureau of Apprenticeship and Training, United States Department of Labor.

(4) That:

(a) WHERE FRINGE BENEFITS ARE PAID TO APPROVED PLANS, FUNDS, OR PROGRAMS

- In addition to the basic hourly wage rates paid to each laborer or mechanic listed in
the above referenced payroll, payments of fringe benefits as listed in the contract
have been or will be made to appropriate programs for the benefit of such employees,
except as noted in section 4(c) below.

(b) WHERE FRINGE BENEFITS ARE PAID IN CASH

- Each laborer or mechanic listed in the above referenced payroll has been paid,
as indicated on the payroll, an amount not less than the sum of the applicable
basic hourly wage rate plus the amount of the required fringe benefits as listed
in the contract, except as noted in section 4(c) below.

(c) EXCEPTIONS

EXCEPTION (CRAFT)	EXPLANATION

REMARKS:

NAME AND TITLE	SIGNATURE

THE WILLFUL FALSIFICATION OF ANY OF THE ABOVE STATEMENTS MAY SUBJECT THE CONTRACTOR OR
SUBCONTRACTOR TO CIVIL OR CRIMINAL PROSECUTION. SEE SECTION 1001 OF TITLE 18 AND SECTION 231 OF TITLE
31 OF THE UNITED STATES CODE.

OSHA[®] FactSheet

OSHA Compliance Assistance

OSHA offers a variety of compliance assistance products and services to help employers comply with OSHA requirements and prevent or reduce workplace fatalities, illnesses, and injuries. These resources include the OSHA website, publications and guidance documents, training materials and courses, cooperative programs, free On-site Consultation services, and Compliance Assistance Specialists. If you are in a state with an OSHA-approved State plan, you may be subject to different or additional requirements, and other compliance assistance resources and cooperative programs may be available to you.

General Information

The OSHA website at www.osha.gov provides information on OSHA's activities and programs, including laws and regulations, Web-based training tools called "eTools," posters and other publications, education and training programs, cooperative programs, and agency contact information. Online users can read OSHA's e-newsletter, *QuickTakes*, which provides timely information about agency activities.

A variety of OSHA publications are available on the agency website and through the OSHA Publications Office. Publications can be ordered online or by calling (800) 321-OSHA.

In addition, employers and employees can call (800) 321-OSHA toll-free for workplace safety and health information or assistance 24 hours a day. Employers and employees can also submit questions electronically to OSHA by clicking on the "Contact Us" link at the bottom of each OSHA webpage.

Non-English-speaking Employers and Employees

OSHA maintains a Spanish-language webpage at www.osha.gov/as/opa/spanish/index.html and a page with compliance assistance resources for employers with Hispanic employees at www.osha.gov/hispanic. In addition, the agency has Spanish-speaking operators available at (800) 321-OSHA. Many OSHA publications, training materials, and videos are available in Spanish.

Education and Training Options

The OSHA Outreach Training Program trains individuals to teach others the basics of occupational safety and health. After taking a one-week course, trainers teach 10- or 30-hour courses on construc-

tion or general industry safety and health standards.

OSHA Training Institute (OTI) Education Centers, located throughout the country, offer OSHA courses and seminars to the public. Courses run from one-half day to four days and vary in price. Topics include recordkeeping, machine guarding, hazardous materials, ergonomics, and construction-related issues. OSHA also presents webcasts on new rules, guidance documents, and technical subjects. Course schedules are available on the OSHA website.

In addition, OSHA awards training grants under the Susan Harwood Training Grant Program to nonprofit organizations to train employees and employers to recognize, avoid, and prevent safety and health hazards in their workplaces.

OSHA's Cooperative Programs

OSHA offers a variety of programs under which businesses, labor groups, and other organizations can work cooperatively with the agency to help prevent fatalities, injuries, and illnesses in the workplace.

Through OSHA's **Alliance Program**, OSHA works with groups committed to safety and health, including businesses, trade or professional organizations, unions, and educational institutions, to leverage resources and expertise to develop compliance assistance tools and resources and share information with employers and employees to help prevent injuries, illnesses, and fatalities in the workplace. OSHA and the organization sign a formal agreement with goals that address training and education, outreach and communication, and promotion of the national dialogue on workplace safety and health.

OSHA's **On-site Consultation Program** offers free and confidential assistance to small and medium-sized businesses in all states across the country, with priority given to high-hazard worksites. Consultation services are totally separate from enforcement and do not result in penalties or citations. The service is largely funded by OSHA and delivered by state governments using well-trained professional staff. Employers can use this service to identify and correct hazards at their worksites and improve their safety and health management systems. Additionally, the On-site Consultation Program recognizes small employers that operate exemplary safety and health management systems through the **Safety and Health Achievement Recognition Program (SHARP)**. Active SHARP sites are exempt from OSHA's programmed inspections.

The **OSHA Strategic Partnership Program (OSPP)** provides the opportunity for OSHA to partner with employers, employees, professional or trade associations, labor organizations, state On-site Consultation Programs, and/or other interested stakeholders. OSHA Strategic Partnerships (OSPs) are designed to encourage, assist, and recognize efforts to eliminate serious hazards and achieve model workplace safety and health practices. Each OSP develops a unique, formal agreement that establishes specific goals, strategies, and performance measures. The OSPP is available to all private sector industries and government agencies in locales where OSHA has jurisdiction.

The **Voluntary Protection Programs (VPP)** are OSHA's premier recognition programs for employers and employees who have implemented exemplary workplace safety and health management systems. A hallmark of VPP is the principle that management, labor, and OSHA work together in pursuit of a safe and healthy workplace. On average, VPP participants have injury and illness rates more than 50 percent below the

Bureau of Labor Statistics' (BLS) national average for their industry. OSHA's other VPP initiatives, VPP Corporate (a streamlined process for large organizations to bring sites into VPP) and VPP Mobile (offered to employers with non-fixed worksites), provide new opportunities to qualify.

The **OSHA Challenge Pilot** uses the VPP model as a foundation to provide a roadmap to eligible employers interested in implementing effective safety and health management systems. Volunteer Administrators help guide the participants through a three-stage process. Graduates of OSHA Challenge receive recognition from OSHA and an invitation to apply for VPP with possible expedited approval. OSHA Challenge is available to general industry and construction employers in the private and public sectors under OSHA's Federal jurisdiction.

The Role of Compliance Assistance Specialists

Compliance Assistance Specialists (CASs) in each OSHA area office provide general information about OSHA standards and compliance assistance resources. Small businesses, trade associations, union locals, community and faith-based groups, and others may call on CASs to speak at seminars, workshops, and other events. CASs promote OSHA's cooperative programs, training opportunities, and information and tools available on the OSHA website or from the agency. CASs are not involved in enforcement activities.

Additional Information

For compliance assistance products and services, call (800) 321-OSHA, visit the OSHA website at www.osha.gov, or contact your nearest OSHA regional, area or state office listed on the website.

This is one in a series of informational fact sheets highlighting OSHA programs, policies or standards. It does not impose any new compliance requirements. For a comprehensive list of compliance requirements of OSHA standards or regulations, refer to Title 29 of the Code of Federal Regulations. This information will be made available to sensory impaired individuals upon request. The voice phone is (202) 693-1999; teletypewriter (TTY) number: (877) 889-5627.

For more complete information:



U.S. Department of Labor
www.osha.gov
(800) 321-OSHA

EMPLOYEE RIGHTS UNDER THE DAVIS-BACON ACT

FOR LABORERS AND MECHANICS EMPLOYED ON FEDERAL OR FEDERALLY ASSISTED CONSTRUCTION PROJECTS

THE UNITED STATES DEPARTMENT OF LABOR WAGE AND HOUR DIVISION

PREVAILING WAGES

You must be paid not less than the wage rate listed in the Davis-Bacon Wage Decision posted with this Notice for the work you perform.

OVERTIME

You must be paid not less than one and one-half times your basic rate of pay for all hours worked over 40 in a work week. There are few exceptions.

ENFORCEMENT

Contract payments can be withheld to ensure workers receive wages and overtime pay due, and liquidated damages may apply if overtime pay requirements are not met. Davis-Bacon contract clauses allow contract termination and debarment of contractors from future federal contracts for up to three years. A contractor who falsifies certified payroll records or induces wage kickbacks may be subject to civil or criminal prosecution, fines and/or imprisonment.

APPRENTICES

Apprentice rates apply only to apprentices properly registered under approved Federal or State apprenticeship programs.

PROPER PAY

If you do not receive proper pay, or require further information on the applicable wages, contact the Contracting Officer listed below:

or contact the U.S. Department of Labor's Wage and Hour Division.



For additional information:

1-866-4-USWAGE
(1-866-487-9243) TTY: 1-877-889-5627



WWW.WAGEHOUR.DOL.GOV

U.S. Department of Labor | Employment Standards Administration | Wage and Hour Division

WH 1321 (Revised April 2009)

EXHIBIT E

DAVIS-BACON AND RELATED ACTS

Questions and Answers

GENERAL

- 1) What is the Davis-Bacon Act (DBA)?

The Davis-Bacon Act (DBA) was enacted by Congress on March 3, 1931, to assure local workers a fair wage and to provide local contractors a fair opportunity to compete for local federal government contracts.

In general, the DBA, as amended, requires that each contract over \$2,000 to which the United States or the District of Columbia is a party for the construction, alteration, and/or repair (including painting or decorating) of public buildings or public works shall contain a clause setting forth the minimum wages to be paid to various classifications of laborers and mechanics employed under the contract. (The Davis Bacon Act is incorporated under 23 U.S.C. 113 as a Davis-Bacon related act statute and is applicable to construction of Federal-aid highways funded with Federal-aid funding. See the discussion on Applicability to Federal-aid Highway projects, questions 7 and 8.)

Contractors and subcontractors are required to pay their laborers and mechanics employed directly upon the "site of the work" no less than the locally prevailing wage and fringe benefit rates for corresponding work on similar projects in the area "regardless of any contractual relationship which may be alleged to exist." The Department of Labor determines and sets the prevailing wage rates. The geographical scope of the DBA is limited, by its terms, to the 50 States and the District of Columbia.

29 CFR Part 5
The Davis-Bacon Act (WH-1246)

- 2) What do the terms "buildings or works" in the Davis-Bacon Act refer to?

The terms "building or work" refer to any construction activity as distinguished from manufacturing, furnishing of materials, or servicing and maintenance work. The terms include, without limitation, buildings, structures, and other facilities on which construction type improvements are performed. Some of the construction type improvements are related to facilities, such as: bridges, dams, plants, highways, parkways, streets, subways, tunnels, sewers, mains, power lines, pumping stations, heavy generators, railways, airports, terminals, docks, piers, wharves, ways, lighthouses, buoys, jetties, breakwaters, levees, canals, dredging, shoring, rehabilitation and reactivation of plants, scaffolding, drilling, blasting, excavating, clearing, and landscaping.

29 CFR 5.2(i)

- 3) What do the terms "construction, prosecution, completion, or repair" in the Davis-Bacon Act refer to?

The terms "construction, prosecution, completion, or repair" refer to all types of work done on a particular building or work at the site thereof, including work at a facility which is deemed a part of the site of the work, including without limitation:

- a) Altering, remodeling, installation (where appropriate) on the site of the building or work on items fabricated off-site;
- b) Painting and decorating;

- c) Manufacturing or furnishing of materials, articles, supplies or equipment on the site of the building or work; and
- d) Transportation between the site of the work and a facility which is dedicated to the construction of the building or work and deemed part of the site of the work, such as:
 - Project office.
 - Tool yards.
 - Batch plants.
 - Borrow pits, etc.

- 4) Is the manufacturing or furnishing of materials, articles, supplies or equipment covered under the Davis-Bacon Act?

The requirements of the Davis-Bacon Act apply to construction, alteration, and/or repair (including painting or decorating) of public buildings or public works. Only when the manufacturing or furnishing of materials, articles, supplies or equipment is conducted in connection with and at the "site of the work" called for in the contract, are those activities covered under the Davis-Bacon Act.

29 CFR 5.2(i)

- 5) What is the minimum contract size/threshold for the prevailing wage rate requirements to apply?

The minimum contract size/threshold for the prevailing wage rate requirements to apply is over \$2,000.

40 U.S.C. 3142(a)

29 CFR 5.5(a)

- 6) Does the minimum contract size/threshold for the prevailing wage rate requirements apply to the contractor and/or subcontractors on a project?

The minimum contract size/threshold of \$2,000 only applies to the prime contractor. All related subcontractors on the project are covered under the DBA regardless of the size of the subcontract.

40 U.S.C. 3142(c)

29 CFR 5.5(a)

APPLICABILITY TO THE FEDERAL-AID HIGHWAY PROJECTS

- 7) What are the "Davis-Bacon Related Acts (DBRA)?"

The Davis-Bacon Related Acts are those Acts extending the Davis-Bacon Act provisions to Federal agencies that provide financial assistance for public works construction through grants, loans, loan guarantees, and insurance. The Federal-aid Highway Acts extended the Davis-Bacon Act provisions to Federally funded construction contracts on Federal-aid highways in the 50 United States, the District of Columbia, Guam, Puerto Rico, the Virgin Islands or other territories.

29 CFR 5.1(a)

23 U.S.C. 113

- 8) What are the Davis-Bacon labor standard clauses that must be included in a covered contract?

The Davis-Bacon Act requires contracting agencies to insert in full on any covered contract the clauses in the regulations at 29 CFR 5.5(a). If a contracting agency has a specific need which requires they modify the clauses, they can do so provided, that such modifications are first approved by the Department of Labor (USDOL). For Federal-aid highway construction projects, the contract clauses required by 29 CFR 5.5(a) are included in Form FHWA-1273 which is required to be physically incorporated in every prime contract and all subcontracts. The required contract clauses address the following topics:

- a) Minimum wages.
- b) Withholdings.
- c) Payrolls and basic records.
- d) Apprenticeships and trainees.
- e) Compliance with Copeland Act requirements.
- f) Subcontracts.
- g) Contract termination; debarment.
- h) Compliance with Davis-Bacon and Related Act requirements.
- i) Disputes concerning labor standards.
- j) Certification of eligibility.

40 U.S.C. 3142(c)
29 CFR 5.5(a)

- 9) Are prevailing wage rate requirements applicable to highway construction projects on Federal-aid highways, as defined in the 23 U.S.C. 113?

The prevailing wage rate requirements apply to any Federal-aid highway construction project (regardless of Federal-aid funding source) over \$2,000 that is:

- a) Located physically within the existing right-of-way of a Federal-aid highway (defined in 23 U.S.C. 101 as "... a highway eligible for assistance under this chapter other than highways classified as local roads or rural minor collectors.)
- b) Located outside the physically existing right-of-way of a Federal-aid highway but is linked to or dependent upon a Federal-aid highway project based on proximity or impact (i.e. without the Federal-aid highway the project would not exist); or
- c) Funded under the Transportation Alternatives Program (TAP) (except for projects carried out under the Recreational Trails Program set-aside).

Transportation Alternatives Program Guidance

- 10) May contracting agencies apply prevailing wage rate requirements to projects not located on a Federal-aid highway?

Yes, although not required to do so contracting agencies may apply prevailing wage rate requirements to projects not located on a Federal-aid highway.

- 11) When a contracting agency uses Federal-aid funds for preliminary engineering, is the related construction project federalized thus making the prevailing wage rate requirements applicable to the construction contract?

NO. The prevailing wage rate requirements apply on a "contract basis." A contracting agency may elect to use Federal-aid funds for the preliminary engineering phase of a project and 100% state funds for the construction phase. Since there are no Federal-aid funds in the construction phase contract, the prevailing wage rate requirements do not apply.

- 12) When a contracting agency "ties" - a Federal-aid funded project to a State or locally-funded project, do the prevailing wage rate requirements apply to all "tied" projects?

Some agencies "tie" or combine separate construction projects for bidding purposes to take advantage of economies of scale, thereby providing an incentive for contractors to provide more competitive bids for all contract lettings. In these cases, the projects are designed, constructed, and administered as separate projects.

- If the "tied" projects are awarded as separate contracts (each contract has its own performance bond, pay items, and separate and distinct funding sources .) and are "tied" for the purpose of bidding and award, then the prevailing wage rate requirements only apply to the Federal-aid funded project or projects.
- If the "tied" projects are awarded as one contract , then the prevailing wage rate requirements apply to all projects since the contract is being funded as a Federal-aid project.

- 13) Do the prevailing wage rate requirements apply to force account contracts for emergency repair work performed by the following parties:

- a) Contracts let by State or local government agencies using force account procedures?

YES. The prevailing wage rate requirements apply to work performed by contractors and subcontractors on State or local government-let contracts using force account procedures.

- b) Work performed by State or local government forces using the force account method?

NO. The prevailing wage rate requirements apply to work performed by contractors or subcontractors. State or local government agencies are not considered contractors or subcontractors, therefore the prevailing wage rate requirements do not apply.

29 CFR 5.2(h)
Memorandum June 26, 2008 (item3)

- 14) Do the prevailing wage rate requirements apply to contracts for emergency repair work solely for debris removal?

NO. Prevailing wage rate requirements do not apply to contracts where the scope of work is solely for the removal of debris and related clean up; however, if the debris removal is performed in conjunction with other repair or reconstruction work, prevailing wage rate requirements apply.

Memorandum June 26, 2008 (item3)

SITE OF THE WORK

- 15) What is the "site of the work" where laborers and mechanics are covered by the prevailing wage rate requirements?"

The "site of the work" is the physical place or places where the building or work called for in the contract will remain once the contract work has been completed and any other site where a significant portion of the building or work is constructed, provided that such site is established specifically for the performance of the contract or project.

29 CFR 5.2(I)(1)

16) What criteria must be satisfied for a facility to be deemed part of the site of the work?

- a) Dedicated exclusively, or nearly so, to the performance of the contract; and
- b) Adjacent or virtually adjacent to the site of the work.

29 CFR 5.2(I)(2)

17) What locations are generally not included in the site of the work?

- a) Permanent home offices;
- b) Branch plant establishment;
- c) Fabrication plants;
- d) Tool yards, etc., of a contractor or subcontractor whose location and continuance in operation are determined wholly without regard to a particular Federal or federally-assisted contract or project; and
- e) Commercial or material supplier fabrication plants, batch plants, borrow pits, job headquarters, tool yards, etc., established by supplier for the project before opening of bids but not on the site of the work.

29 CFR 5.2(I)(3)

18) Under what circumstances are truck drivers covered under the DBRA?

- a) Drivers of a contractor or subcontractor for time spent working on the site of the work;
- b) Drivers of a contractor or subcontractor for time spent loading and/or unloading materials and supplies on the site of the work, if such time is not de minimis;
- c) Truck drivers transporting materials or supplies between a facility that is deemed part of the site of the work and the actual construction site; and
- d) Truck drivers transporting portion(s) of the building or work between a site established specifically for the performance of the contract or project where a significant portion of such building or work is constructed and the physical place(s) where the building or work called for in the contract(s) will remain.

Prevailing Wage Resource Book, DBA/DBRA Compliance Principles, Truck Drivers

19) Under what circumstances are truck drivers not covered under the DBRA?

- a) Material delivery truck drivers while off "the site of the work;"
- b) Drivers of a contractor or subcontractor traveling between a Davis-Bacon job and a commercial supply facility while they are off the "site of the work;" and
- c) Truck drivers whose time spent on the site of the work is de minimis, such as only a few minutes at a time merely to pick up or drop off materials or supplies.

Prevailing Wage Resource Book, DBA/DBRA Compliance Principles, Truck Drivers

20) When site of the work issues arise, how are they resolved?

The USDOL Wage and Hour Division should be consulted when contracting agencies are confronted with "site of the work" issues. Refer to WHD Local Offices for information on contacting the local offices of the USDOL Wage and Hour Division.

- 21) Are the prevailing wage rate requirements applicable on projects to move or relocate facilities necessary for an associated Federal-aid construction project in the following situations?

- a) Contract let by a railroad or utility.

When a railroad or utility let a contract to move or relocate their facility to accommodate a highway construction project, payment under the contract is considered compensation for moving or relocating their facility, and not highway construction; therefore the prevailing wage rate requirements do not apply.

- b) Highway construction contract.

When the work to move or relocate a railroad or utility to accommodate a highway construction project is performed under the highway construction contract, the work is considered highway construction; therefore the prevailing wage rate requirements apply.

Memorandum June 26, 2008 (fourth item)

- 22) Are ferry boat projects covered by the prevailing wage rate requirements?

The construction and reconstruction of ferry boats and docking facilities is considered work performed upon "public works" within the meaning of the Davis-Bacon Act. When the location of the contract performance is known when bids are solicited, a wage determination would be issued. See DOL's Field Operations Handbook, Section 15d11 for guidance.

WHO IS COVERED UNDER THE DBA?

- 23) Who is covered under the Davis-Bacon Act?

The requirements of the Davis-Bacon Act apply to laborers and mechanics, which are those workers performing work that is physical and/or manual in nature (including those who use tools or who are performing the work of a trade), and employed by a contractor or subcontractor on the "site of the work," as distinguished from mental or managerial work. Laborers and mechanics also include apprentices, trainees, and helpers.

Laborers and mechanics do not include workers whose duties are primarily administrative, executive, or clerical rather than manual. In instances where supervisory employees and other employees whose work is not physical in nature (such as foremen, and other non-laborers and non-mechanics workers) devote over 20% of their time in a work week to physical and/or manual labors, they are covered under the DBA for the time spent performing the work of a laborer or mechanic. Persons employed in a bona fide executive, administrative, and professional capacity are not covered under the Davis-Bacon Act.

29 CFR 5.2(m)

- 24) What are some of the worker classifications covered under the Davis-Bacon Act?

The following are some of the worker classifications of laborers or mechanics covered under the Davis-Bacon Act:

- a) Carpenters.

- b) Electricians.
- c) Plumbers.
- d) Ironworkers.
- e) Flaggers.
- f) Craftsmen.
- g) Welders.
- h) Concrete Finishers.
- i) Longshoremen.
- j) Power Equipment Operators.
- k) Helpers.
- l) Workers participating in a special program that has not established specific wage rates and other compensations for the participants.

AAM No. 141

- 25) What are some of the worker classifications generally NOT covered under the Davis-Bacon Act?

The following worker classifications of laborers or mechanics are generally NOT covered under the Davis-Bacon Act:

- a) Architects.
- b) Engineers.
- c) Timekeepers.
- d) Supervisors.
- e) Foremen.
- f) Workers performing exploratory drilling services, such as subsurface utility engineering or utility location services, for the purpose of obtaining data to be used in engineering studies and the planning of a project. (The work performed is related to an activity and not a project; therefore the Davis-Bacon Act does not apply.)
- g) Employees of railroads.
- h) Employees of public utilities.
- i) Contracting agency inspectors.
- j) Public agency employees performing work on a public Agency force account basis.
- k) Contractor Quality Assurance Inspector.
- l) Material men and suppliers.
- m) Survey crew members using the equipment for measuring heights, distances, and bearings.
- n) Owner-Operators of trucks who drive their own trucks (The certified payroll would indicate that the work was performed by named "owner-operator" but would not need to show hours worked or the rate of pay).
- o) Bona fide programs approved by the USDOL with established wage rates, living allowances and other compensation. Some of the programs included:
 1. Summer youth opportunity programs, such as those sponsored by union and management or by a governmental or community group, and
 2. Federal Youth Program, such as: Youth Conservation Corps, Public Land Corps, American Conservation and Youth Service Corps (AmeriCorps), and Volunteers in Service to America (VISTA).

- 26) What are the requirements for apprentices and trainees?

The USDOL requirements of 29 CFR 5.5(a)(4)(i) and (ii) apply to apprentices and trainees individually registered in a bona fide apprenticeship program registered with the USDOL, Employment and Training Administration, Office of Apprenticeship Training, Employer and

Labor Services, or with a State Apprenticeship Agency recognized by the Office. Even though apprentices and trainees are laborers and mechanics, these worker classifications are not listed on a wage determination. The wages and fringe benefits rates they receive are specified in their approved training program and may be less than the journeyman rate for the type of work performed.

Apprentices and trainees performing on Federal-aid highway construction contracts and enrolled in programs certified by the Secretary of the Department of Transportation are exempt from the DBRA requirements of 29 CFR 5.5(a)(4)(i) and (ii) for apprentices and trainees.

23 U.S.C. 113(c)
29 CFR 5.5(a)(4)(i)
29 CFR 5.5(a)(4)(ii)

27) Is a helper classification included in a General Wage Determination?

NO. The wage and fringe benefit rates for a helper classification are not included in a General Wage Determination. The helper classification must be included in a project wage determination, or added by the USDOL Wage and Hour Division, only when the following conditions are met:

- a) The work duties are clearly defined and distinct from any other classification in the wage determination;
- b) The work performed by a helper is not performed by a classification in the wage determination;
- c) The use of helpers is an established prevailing practice in the area; and
- d) The helper is not employed as a trainee in an informal training program.

29 CFR 5.2 (n)(4)

WAGE DETERMINATIONS

28) What is a "wage determination?"

A "wage determination" is the listing of wage rates and fringe benefit rates for each classification of laborers and mechanics which the Administrator of the Wage and Hour Division of the USDOL has determined to be prevailing in a given geographical area for a particular type of construction (e.g., building, heavy, highway, or residential). The prevailing wage is the wage paid to the majority (more than 50 percent) of the laborers or mechanics in the classification on similar projects in the area during the same period. If the same wage is not paid to a majority of those employed in the classification, the prevailing wage shall be the average of the wages paid, weighted by the total employed in the classification. A "wage determination" includes not only the original determination (or decision) but any subsequent determinations modifying, superseding, correcting, or otherwise changing the rates and scope of the original determination.

The USDOL Wage and Hour Division issues two types of wage determinations: general wage determinations, also known as area wage determinations, and project wage determinations.

29 CFR 1.2(a)(1)
WHD Davis-Bacon and Related Acts Frequently Asked Questions, I.

29) What is a "general wage determination?"

A "general wage determination" (GWD) reflects those rates determined to be prevailing in a specific geographic area for the type of construction described. "General wage determinations," including any subsequent decisions modifying, superseding, correcting, or otherwise changing the rates and scope of the original wage decision, contain no expiration dates and are effective from their date of publication on the Wage Determination On Line (WDOL) web site at <http://www.wdol.gov>; or notice in the Federal Register; or on the date the written notice is received by the contracting agency, whichever is earlier.

When a contracting agency has a proposed construction project to which a published GWD would be applicable, that wage determination may be used by the contracting agency without consulting the USDOL, provided that questions concerning its use shall be referred to the USDOL in accordance with 29 CFR 1.6(b).

When a contracting agency has a proposed construction project to which there is not an applicable published GWD, the contracting agency must request a wage determination using Standard Form (SF) 308, "Request For Wage Determination And Response To Request."

29 CFR 1.6(a)(2)

Wage Determination OnLine (WDOL)

WHD Davis-Bacon & Related Acts Frequently Asked Questions, I., General WD

30) What is a "project wage determination?"

A "project wage determination" is a wage determination for a specific named construction project. It is issued at the request of a Federal agency or a "State highway department under the Federal-aid Highway Acts" using Form SF-308, "Request For Wage Determination And Response To Request." A "project wage determination" expires 180 calendar days from the date of issuance unless an extension of the expiration date is requested by the contracting agency and approved by the USDOL Wage and Hour Division.

29 CFR 1.6

29 CFR 1.5(b)

Standard Form (SF) 308

WHD Davis-Bacon & Related Acts Frequently Asked Questions, I., Project WD

31) When a wage determination does not contain a classification of worker needed to complete construction of a project, can the wage and fringe benefit rates for a worker classification be transferred to other workers on the project?

NO. The wage and fringe benefit rates for worker classifications listed in wage determinations are unique to a particular type of construction and the type of work being performed. Therefore, wage and fringe benefit rates for a worker classification are not transferrable to other worker classification.

32) What are the procedures for requesting a missing worker classification?

The contracting agency shall require that any classification of laborers or mechanics which are not listed in the wage determination and which are to be employed under the contract be classified in conformance with the wage determination.

When a classification considered necessary for performance of the work is missing from the WD, the contractor must initiate a request for approval for a proposed wage and benefit rate that conforms to the wage determination. The contractor can initiate this action by preparing a Standard Form 1444 (SF-1444), *Request for Authorization of Additional Classification and Rate.* The wage rate proposed by the contractor must bear a "reasonable relationship" to the wage rates in the WD.

AAM No. 213

When only one classification necessary for performance of the work is missing in the WD, the contracting agency may request a project wage determination using Standard Form (SF) 308, "Request For Wage Determination And Response To Request." Once the contract has been awarded, the project wage determination may be incorporated into the contract through supplemental agreement or through change order.

WHD Davis-Bacon and Related Acts Frequently Asked Questions, VI.

- 33) What criteria must be satisfied for an additional worker classification to be approved by the USDOL Wage and Hour Division?

The approval of an additional worker classification and the proposed wage and fringe benefits rates requires that the following criteria be satisfied:

- a) The work to be performed by the worker classification requested is not performed by any other worker classification in the wage determination; and
- b) The worker classification requested is utilized in the area by the construction industry; and
- c) The proposed wage rate, including any bona fide fringe benefits, bears a reasonable relationship to the wage rates contained in the wage determination; and
- d) There is evidence of agreement on the worker classification and proposed wage rate among the parties involved, or the views of those involved -- the contractor(s), employees (if known) or their representative, and the contracting officer/agency -- are forwarded for consideration to the Wage and Hour Division; and
- e) The request does not involve wage rates for apprentices or trainees.

29 CFR 5.5(a)(1)(ii)

WHD Davis-Bacon and Related Acts Frequently Asked Questions, VI.

- 34) Who is responsible for deciding which wage determination would be appropriate to use on a specific project?

The contracting agency is responsible for determining the applicable wage determination to furnish to all parties involved on a project. See Where can I obtain a copy of the General Wage Determination needed for a covered federal project? for more details.

- 35) How does the USDOL Wage and Hour Division determine prevailing wages?

The US DOL Wage and Hour Division establishes prevailing wage rates using available data showing the rates for the type of construction and worker classification prevailing in a specific geographical area. The sources of data may include, but is not limited to:

- a) Conducting in-house reviews of payroll data, or
- b) Conducting surveys of wage data from active projects.

- 36) What prevailing wage determination applies to laborers and mechanics engaged in warranty or repair work under a construction contract?

The original contract prevailing wage determination applies regardless of when the warranty work is done. This is true whether or not there is a pay item for the warranty work.

29 CFR 1.6(a)(1)
AAM No. 157

- 37) What prevailing wage determination should be used when a project is located on the border between two States with separate wage determinations?

The prevailing wage determinations are based on the prevailing wage rates for the area that the work will be performed. When a project site of the work is located in more than one area with separate wage determinations, the contracting agency has two options:

- a) Include all applicable GWDs in the contract, therefore, the contractor is required to pay employees based on where the work was performed using the appropriate GWD, or;
- b) Request a project wage rate determination for the project using Standard Form (SF) 308, "Request for Wage Determination and Response to Request."

- 38) What wage rate determination should be used on a contract that has more than one wage rate schedule with the same worker classification?

The contracting agency is responsible for insuring that only the appropriate wage determination(s) are incorporated in bid solicitations and contract specifications, and for designating specifically the work to which such wage determination will apply. It is possible for a project to have a worker classification for heavy construction and the same worker classification for highway construction. Because of the complexities in applying multiple wage rate schedules, the contracting agency should consult with the Wage and Hour Division to resolve any questions.

29 CFR 1.6(b)

- 39) Is the contractor allowed an equitable adjustment if a correction is necessary for a wage determination based on a clerical error by the USDOL?

YES. The contractor is compensated for any increases in wages resulting from a necessary wage rate modification retroactive to the beginning of construction through the effective date of the modification.

- 40) Do new wage determinations apply to construction contracts that have already been awarded?

A proper wage determination incorporated into a bid solicitation and related contract award establishes the minimum wage and fringe benefits rates which must be paid to the

laborers and mechanics for the entire term of the contract. Modifications to a wage determination issued after the bid opening do not apply.

Upon his or her own initiative or at the request of a contracting agency, the USDOL Wage and Hour Division may correct any wage determination believed to contain an inadvertent clerical error. Such corrections shall be included in any bid specifications containing the wage determination, or in any on-going contract containing the wage determination in question, retroactively to the start of construction.

29 CFR 1.6(d)
Prevailing Wage Rates

- 41) What prevailing wage determination applies when a contracting agency executes an option provision in a multi-year contract to extend the terms of the contract for a specified period of time?

When a contracting agency executes an option provision in a multi-year contract to extend the terms of the contract for a specified period of time, the prevailing wage determination effective at that time the option was executed must be incorporated into the contract. See November 20, 1998, Federal Register Notice titled: "Guidance to All Government Contracting Agencies of the Federal Government and the District of Columbia Concerning Application of Davis-Bacon Wage Determinations to Contracts With Option Clauses" for detailed guidance.

- 42) What is a supersedeas wage determination?

Supersedeas Wage Determinations are issued annually to replace general decisions issued in the previous edition of the publication entitled General Wage Determinations issued under the Davis-Bacon and Related Acts. Supersedeas project wage determinations may also be issued.

Supersedeas decisions affecting determinations are effective under the same circumstances as "modifications." Whereas a modification to a wage determination may make changes in only selected provisions of the wage determination, a supersedeas determination replaces the entire existing wage decision.

WHD Davis-Bacon and Related Acts Frequently Asked Questions, I.

- 43) What is the 10-day rule?

A contracting agency is responsible for incorporating the applicable wage rate determination into each federally-assisted contract entered into pursuant to competitive bidding procedures. When notice of a change to a wage determination is published in the Federal Register 10 days or more before the opening of bids, the USDOL requires that the new wage determination be incorporated into the contract by amendment.

29 CFR 1.6(c)(3)(i)

- 44) When a contracting agency has failed to incorporate a wage determination in a covered contract and/or has incorporated a wage determination that clearly does not apply to the contract (e.g. inaccurate description of project, inaccurate location in a wage determination request), what can the contracting agency do?

- a) Terminate and re-solicit the contract with a valid wage determination, or
- b) Incorporate a valid wage determination retroactive to the beginning of construction

through supplemental agreement or through change order. The contractor must be compensated for any increases in wages resulting from such contract change.

29 CFR 1.6(f)

CONTRACT ADMINISTRATION

45) Where are the prevailing wage determinations found?

Prevailing wage determinations are available on the internet at: Wage Determinations OnLine.gov.

46) May a contracting agency reference the wage determination(s) in a bid proposal?

YES. The contracting agency may reference the wage determination(s) in a bid proposal.
FHWA Questions and Answers Regarding Electronic Contracting, No. 7

47) May a contracting agency reference the wage determination(s) in a construction contract?

NO. The contract between the contracting agency and the contractor (or between the contracting agency and the design-builder) must physically incorporate the applicable wage determination(s) into that contract.

FHWA Questions and Answers Regarding Electronic Contracting, No. 7

48) May a prime contractor reference the wage determination(s) in their contracts with subcontractors?

NO. The contracts between the prime contractor and the subcontractors must physically incorporate the applicable wage determination(s) into those contracts.

RECORDKEEPING / PAYROLL

49) What payroll and basic information must contractors and subcontractors covered by the Davis-Bacon Act maintain for all laborers and mechanics employed on the site of the work?

- a) Name;
- b) Address;
- c) Full social security number;
- d) Worker classification;
- e) Regular hourly rate of pay, including rates of contributions or costs anticipated for fringe benefits or their cash equivalents;
- f) Daily and weekly numbers of hours worked;
- g) Deductions;
- h) Actual wage paid;
- i) If applicable, detailed information regarding various fringe benefit plans and programs, including records that show that the plan or program has been communicated in writing to the laborers and mechanics affected; and
- j) If applicable, detailed information regarding approved apprenticeship or trainee programs.

29 CFR 5.5(a)(3)(i)

- 50) What information must contractors and subcontractors provide on the weekly certified payroll submittals?

Contractors and subcontractors performing on contracts covered by the Davis-Bacon Act are required to pay laborers and mechanics on a weekly basis. They must submit a weekly payroll statement to the contracting agency that includes the following information:

- a) Name of each worker;
- b) Employee identification number (e.g., the last four digits of the employee's social security number);
- c) Worker classification;
- d) Hourly rates of wages paid;
- e) Daily and weekly number of hours worked;
- f) Deductions (fringe benefits, etc.) made; and
- g) Actual wages paid.

29 CFR 5.5(a)(3)(ii)

- 51) Does the USDOL require weekly certified payrolls to be submitted on form WH-347?

The Form WH-347 is available for the convenience of contractors and subcontractors in submitting weekly certified payrolls. Use of the form is optional; however, the information necessary to properly fill out the form satisfies the requirements of a certified payroll submission in connection with contracts subject to the Davis-Bacon and related Acts and the Copeland Act. A properly executed certification set forth on the reverse side of Form WH-347 satisfies the requirement for submission of the "Statement of Compliance."

By signing the "Statement of Compliance," the contractor or subcontractor is certifying that the following statements for the pay period are correct:

- a) The information required under 29 CFR 5.5(a)(3)(ii) and 29 CFR 5.5(a)(3)(i) is being maintained and is correct and complete;
- b) Each laborer or mechanic (including each helper, apprentice, and trainee) employed on the contract has been paid the full weekly wages earned, without rebate, either directly or indirectly, and that no deductions have been made either directly or indirectly from the full wages earned, other than permissible deductions as set forth in 29 CFR Part 3; and
- c) Each laborer or mechanic has been paid not less than the applicable wage rates and fringe benefits or cash equivalents for the classification of work performed, as specified in the applicable wage determination incorporated into the contract.

- 52) Do the record retention requirements that apply to paper records also apply to records maintained electronically?

YES. When records are maintained electronically, contractors must take care to ensure that good records management system practices are used and that the electronic records system provides integrity, accuracy, authenticity, and reliability. As an example, see the guidance provided by the Office of Federal Contract Compliance Programs - "Retention Provisions for Electronic Records."

- 53) How long are contractors and subcontractors required to retain employee records, including payroll records?

Contractors and subcontractors must retain employee records, including payroll records, during the course of the contract work and three years after final payments and all other pending matters are closed; i.e. FHWA's final acceptance of the project.

29 CFR 5.5(a)(3)(i)
23 CFR 635.118
49 CFR 18.36(i)(11)

- 54) Are electronic submittals and electronic signatures acceptable for the contractor's weekly payroll and the "Statement of Compliance" submittals?

YES. The USDOL Wage and Hour Division permits the use of electronic submittals and electronic signatures for the contractor's weekly payroll and the "Statement of Compliance" submittals. For more information, refer to the USDOL's November 12, 2004, letter regarding Electronic Signatures and the Copeland Act.

29 CFR 5.5(a)(3)
WH-347 and instructions

OVERSIGHT

- 55) What are the functions/responsibilities of the U.S. Department of Labor under the Davis-Bacon Act?

The U.S. Department of Labor (USDOL) Wage and Hour Division has regulatory and oversight authority to assure coordination of administration and consistency of enforcement of the labor standards provisions of the Davis-Bacon Act. The USDOL Wage and Hour Division issues regulations establishing standards and procedures for the administration and enforcement of the Davis-Bacon labor standard provisions.

- 56) What are the responsibilities of FHWA and recipients of federal assistance under the Federal Aid Highway Acts in administering and ensuring compliance with the labor standard provisions of the Davis-Bacon Act?

The FHWA has the overall responsibility for ensuring that recipients in the Federal-aid highway program comply with the requirements and policies for prevailing wage rates on covered construction contracts. The FHWA is responsible for ensuring that all contracting agencies (State DOTs, local public agencies, and other grant recipients) are correctly administering prevailing wage rate requirements. The FHWA oversees compliance of these requirements through a risk-based stewardship and oversight program administered by each FHWA Division Office but is also charged under DOL guidance to conduct such investigations as appropriate to enforce Davis Bacon Act requirements.

On Federal-aid highway construction projects, contracting agencies are responsible for properly applying and enforcing prevailing wage rate requirements in covered contracts including:

- a) Verifying that covered contracts have incorporated the required Davis-Bacon clauses and the applicable wage determination(s);
- b) Verifying that the Davis-Bacon notice and the applicable wage determination(s) are displayed at the site of the work in a conspicuous location in clear view of everyone;
- c) Reviewing certified payrolls in a timely manner;
- d) Conducting employee interviews;
- e) Conducting reviews and investigations of covered contracts in conjunction with FHWA

- as appropriate;
- f) Forwarding refusal to pay and/or debarment consideration cases to the USDOL Wage and Hour Division for appropriate action; and
- g) Submitting enforcement reports and semi-annual enforcement reports to the USDOL Wage and Hour Division.

57) What are some of the typical violations of the DBRA?

The following are some of the typical violations of the Davis-Bacon and Related Acts requirements:

- a) Misclassification of laborers and mechanics;
- b) Failure to pay full prevailing wage, including fringe benefits, for all hours worked (including overtime hours);
- c) Inadequate recordkeeping, such as not counting all hours worked or not recording hours worked by an individual in two or more classifications during a day;
- d) Failure of to maintain a copy of bona fide apprenticeship program and individual registration documents for apprentices;
- e) Failure to submit certified payrolls weekly; and
- f) Failure to post the Davis-Bacon poster and applicable wage determination.

58) What is FHWA's guidance regarding late submittals of weekly payroll statements?

Unless the contractor provides a satisfactory explanation, the FHWA recommends that the contracting agency consider initiating a compliance investigation if a contractor is habitually late in submitting payroll statements.

59) What actions can be taken when a contractor is continually late with payroll submittals?

The contracting agency must send the prime contractor a written notice restating the contract requirements for submitting the weekly payroll statements. If the contractor continues to submit the payroll statements late, the following actions can be taken:

- a) Withhold payments until the payroll submittal requirements are met;
- b) Terminate the contract; or
- c) Refer the violating contractor to the USDOL for possible legal prosecution and/or debarment.

60) What actions can be taken if a contractor is not paying prevailing wages?

The contracting agency may withhold contract funds, on its own initiative or at the direction of the USDOL, in a sufficient amount to satisfy any alleged wage underpayments ending resolution of a wage dispute.

When a subcontractor has not paid the prevailing wages, the prime contractor who is responsible for compliance on the contract and liable for any back wages not paid, may decide to withhold final payment from the subcontractor until the back wage issues are resolved.

When contractors or subcontractors are found to have disregarded their obligations to employees, or to have committed aggravated or willful violations while performing work on

Davis-Bacon Act covered projects, they may be subject to contract termination and debarment from future contracts for up to three years.

40 U.S.C. 3142(c)(3)

29 CFR 5.5(a)(2)

29 CFR 5.5(b)(3)

- 61) Who is responsible for assuring that the standard provisions of the Davis-Bacon and Related Acts have been inserted into covered federally-assisted construction contracts?

The Federal agency is responsible for ascertaining whether the clauses required by 29 CFR 5.5 have been inserted into construction contracts covered under the Davis-Bacon and Related Acts. For Federal-aid highway construction projects, FHWA requires the inclusion of form FHWA-1273 which incorporates the contract clauses of 29 CFR 5.5.

23 CFR Part 633

- 62) What action should a contracting agency take when there is cause to believe a back wage violation exists?

The contracting agency should withhold, or cause to be withheld, from the contractor as much of the accrued payments or advances as may be considered necessary to pay laborers and mechanics, including apprentices, trainees, and helpers, employed by the contractor or any subcontractor the full amount of wages required by the contract. The funds are withheld from active contracts or any other contracts of the contractor where the prevailing wage rates apply.

29 CFR 5.5(a)(2)

- 63) What can contracting agencies do in situations where back wage violations occurred on a contract that has been accepted and paid as complete?

When funds remain on a contract under which a violation occurred are insufficient to cover back wages due, the contracting agency can withhold funds from other contracts subject to DBRA or any other federal contract held by the same prime contractor.

29 CFR 5.5(a)(2)

- 64) Can a contracting agency use accrued funds withheld from a contractor for payment of wages be used to resolve other contract claims against the contractor?

NO. The wages due underpaid employees have priority over any competing claims against the contractor.

INTERVIEWS

- 65) How often should employee interviews in a compliance inspection of an employer be conducted by the contracting agency?

Employee interviews should be conducted at a frequency and number sufficient to establish the degree of adequacy and accuracy of the records, and the nature and extent of any violations. They should also be representative of all classifications of employees on the project under investigation. In doubtful compliance situations, interviews with former employees may be appropriate.

29 CFR 5.6 (a)(3)

- 66) An employee has been underpaid. What steps should be taken to resolve the issue?

The contracting agency may withhold funds sufficient to pay the unpaid employees. Considering the violation is a breach of contract, the contract may be termination, and/or the contractor or subcontractor may be debarred from obtaining any type of federally-funded contract for up to 3 years.

- 67) Are employee interviews intended to be confidential from the contractor?

Yes, employee interviews are intended to be private from their employer. Each employee should be informed that the information given is confidential, and that his/her identity will not be disclosed to the employer without the employee's written permission.

PWRB 2013, Investigative Procedures Under DBRA/CWHSSA

- 68) Do the prevailing wage rate requirements apply to all Recovery Act contracts?

YES. The first sentence of ARRA Section 1606 states in part: "Notwithstanding any other provision of law and in a manner consistent with other provisions of this Act . . ." This language explicitly overrides any limitation to Davis-Bacon coverage that may be contained in other Davis-Bacon related Acts. Specifically, the Highway Acts exclusion of highways functionally classified as local roads and rural minor collectors and limitation of applicability to projects located within the right-of-way does not apply to Recovery Act projects. For additional information, refer to the ARRA Guidance and the all agency memorandum AAM No. 207 – "Applicability of Davis-Bacon to Federal and federally-assisted construction work funded by the American Recovery and Reinvestment Act of 2009."

- 69) Who is responsible for assuring that the contractor has included the appropriate wage determination(s) in the contract?

The contracting agency is responsible for assuring that the appropriate wage determination is included in the contract.

29 CFR 1.6(b)

- 70) Who is responsible for compliance with the DBA labor standard provisions in a construction contract?

The prime contractor has overall responsibility for compliance with the DBA labor standard provision in a construction contract.

29 CFR 5.5(a)(6)

POSTERS

- 71) What Davis-Bacon Act notice or poster must be displayed on Federal-aid funded construction projects?

Covered contractors and subcontractors are required to display the "Rights Under the Davis-Bacon Act" notice (WH-1321) on the job site in a prominent and accessible place where it can be easily seen by the workers. The applicable wage determination must be similarly posted.

WH-1321, "Employees Rights Under the Davis-Bacon Act"
WH-1321sp, "Derechos Del Empleado Bajo La Ley Davis-Bacon"

- 72) Where can contractors and subcontractors obtain the workplace notices or posters required for Federal-aid funded construction projects?

The notices or posters required on Federal-aid funded constructions projects are available at no cost in electronic and printed form from the Department of Labor. For assistance in complying with federal workplace notices or posters requirements, see DOL Poster Compliance Assistance.

Where can I find workplace posters?
Job Site Posters

- 73) Where should contractors and subcontractors display workplace notices or posters required on Federal-aid funded construction projects?

Workplace notices or posters must be displayed at all times by the contractor and subcontractors at the site of the work in a prominent and accessible place where they can be easily seen by the workers.

Where should I post the required federal posters?
29 CFR 5.5(a)(1)(i)

- 74) What is FHWA's position for displaying notices or posters on short-term projects when there is not a job office location?

When a job office is not established due to the nature of the work and/or the length of the contract, the contractor and subcontractors must display all notices or posters at their home offices where hiring is conducted and each employee must be provided copies of all the notices or posters and sign a statement acknowledging they received and understood the content of all the notices or posters.

- 75) Can the required workplace notices or posters be placed in a binder that is accessible in a supervisor's or foremen's vehicle when a job office has not been established for a covered Federal-aid construction project?

NO. Placing the required workplace posters in a binder does not meet the requirement for displaying or posting in a conspicuous place where they are easily visible to all employees — the intended audience.

Can I put the required posters in a binder that I put on the wall?

Record of Employee Interview

U.S. Department of Housing and Urban Development Office of Labor Relations

OMB Approval No. 2501-0009
(exp.09/30/2017)

Public reporting burden for this collection of information is estimated to average 15 minutes per response, including the time for reviewing instructions, searching existing data sources, gathering and maintaining the data needed, and completing and reviewing the collection of information. This agency may not collect this information, and you are not required to complete this form, unless it displays a currently valid OMB control number. The information is collected to ensure compliance with the Federal labor standards by recording interviews with construction workers. The information collected will assist HUD in the conduct of compliance monitoring; the information will be used to test the veracity of certified payroll reports submitted by the employer. **Sensitive Information.** The information collected on this form is considered sensitive and is protected by the Privacy Act. The Privacy Act requires that these records be maintained with appropriate administrative, technical, and physical safeguards to ensure their security and confidentiality. In addition, these records should be protected against any anticipated threats or hazards to their security or integrity that could result in substantial harm, embarrassment, inconvenience, or unfairness to any individual on whom the information is maintained. **The information collected herein is voluntary, and any information provided shall be kept confidential.**

1a. Project Name			2a. Employee Name		
1b. Project Number			2b. Employee Phone Number (including area code)		
1c. Contractor or Subcontractor (Employer)			2c. Employee Home Address & Zip Code		
			2d. Verification of Identification? Yes <input type="checkbox"/> No <input type="checkbox"/>		
3a. How long on this job?	3b. Last date on this job before today?	3c. No. of hours last day on this job?	4a. Hourly rate of pay?	4b. Fringe Benefits?	
				Vacation Yes <input type="checkbox"/> No <input type="checkbox"/>	Yes <input type="checkbox"/> No <input type="checkbox"/>
				Medical Yes <input type="checkbox"/> No <input type="checkbox"/>	
				Pension Yes <input type="checkbox"/> No <input type="checkbox"/>	
4c. Pay stub? Yes <input type="checkbox"/> No <input type="checkbox"/>					

5. Your job classification(s) (list all) -- continue on a separate sheet if necessary

6. Your duties

7. Tools or equipment used

8. Are you an apprentice or trainee?	Y	N	10. Are you paid at least time and 1/4 for all hours worked in excess of 40 in a week?	Y	N
<input type="checkbox"/>	<input type="checkbox"/>	<input type="checkbox"/>	<input type="checkbox"/>	<input type="checkbox"/>	<input type="checkbox"/>
9. Are you paid for all hours worked?			11. Have you ever been threatened or coerced into giving up any part of your pay?		
<input type="checkbox"/>	<input type="checkbox"/>	<input type="checkbox"/>	<input type="checkbox"/>	<input type="checkbox"/>	<input type="checkbox"/>

12a. Employee Signature	12b. Date
--------------------------------	------------------

13. Duties observed by the interviewer (Please be specific.)

14. Remarks

15a. Interviewer name (please print)	15b. Signature of interviewer	15c. Date of interview
---	--------------------------------------	-------------------------------

Payroll Examination

16. Remarks

17a. Signature of Payroll Examiner	17b. Date
---	------------------

EDA PROJECT SIGN

The Contractor shall supply, erect, and maintain in good condition a project sign according to the specifications set forth below:

EDA SITE SIGN SPECIFICATIONS

Size: 4' x 8' x ¾"

Materials: Exterior grade/MDO plywood (APA rating A-B)

Supports: 4" x 4" x 12' posts with 2" x 4" cross branching

Erection: Posts shall be set a minimum of three feet deep in concrete footings that are at least 12" in diameter.

Paint: Outdoor enamel

Colors: Jet Black, Blue (PMS300), and Gold (PMS7406). Specifically, on white background the following will be placed:

The U. S. Department of Commerce seal in blue, black, and gold;

"EDA" in blue;

"U. S. DEPARTMENT OF COMMERCE ECONOMIC DEVELOPMENT

ADMINISTRATION" in black;

"In partnership with" in blue;

(Actual name of the) "EDA Grant Recipient" in black;

Lettering: Specific fonts are named below; positioning will be as shown on the attached illustration.

"U. S. DEPARTMENT OF COMMERCE ECONOMIC DEVELOPMENT
ADMINISTRATION" use Bank Gothic Medium - **BANK GOTHIC MED**

"In partnership with" use UniversTM 55 Oblique - **Univers 55**

(Name of) "EDA Grant Recipient" use UniversTM Extra Black 85 **Univers 85**

Project signs will not be erected on public highway rights-of-way. If any possibility exists for obstruction to traffic line of sight, the location and height of the sign will be coordinated with the agency responsible for highway or street safety in the area.

The EDA Regional Director may permit modifications to these specifications if they conflict with state law or local ordinances.

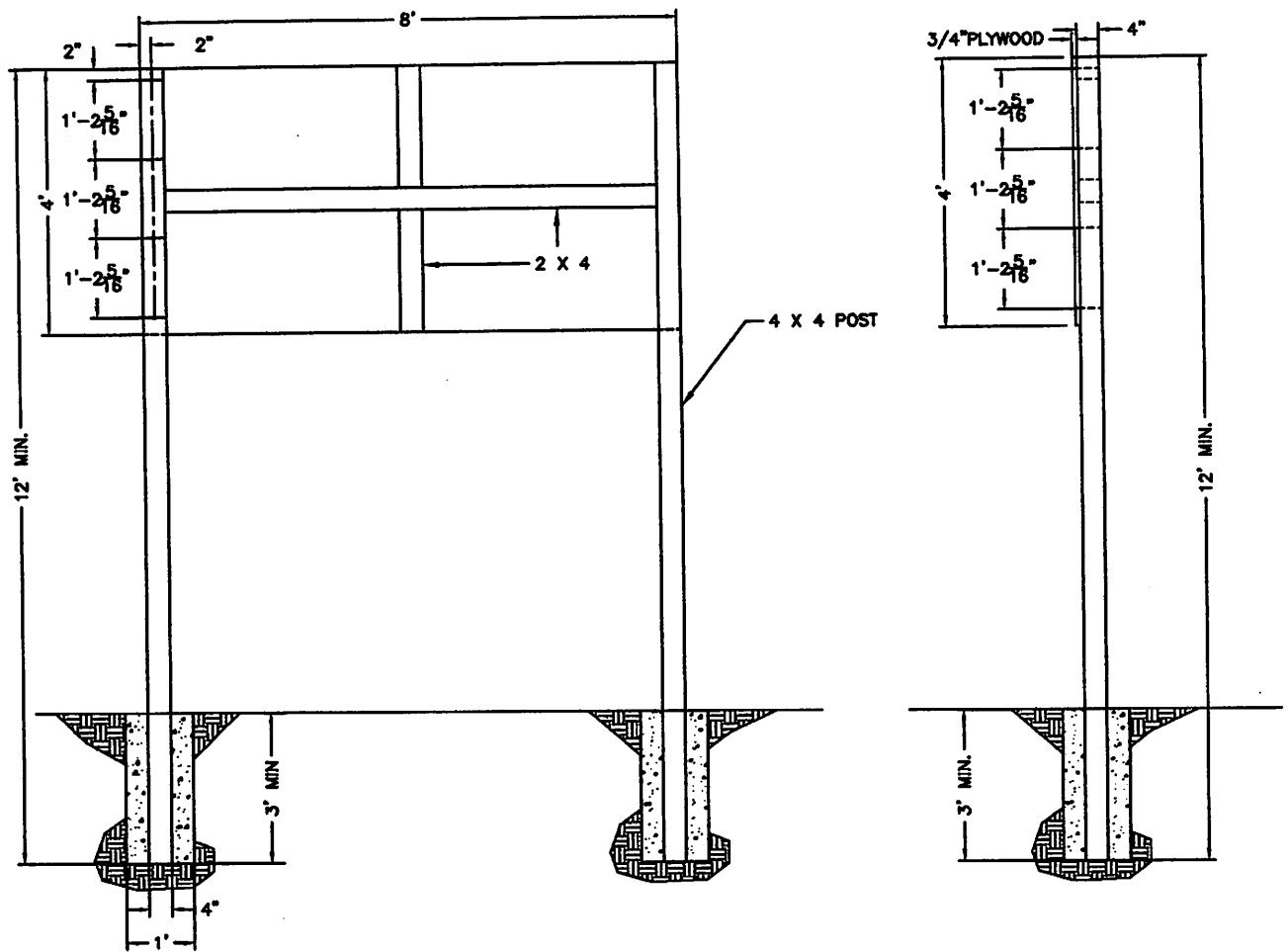

SIGN B
 PLYWOOD SIGN
 SCALE: 3/8" = 1'

PROJECT - SIGN B

ECONOMIC DEVELOPMENT ADMINISTRATION

Black
Blue= PMS300
Gold= PMS7406

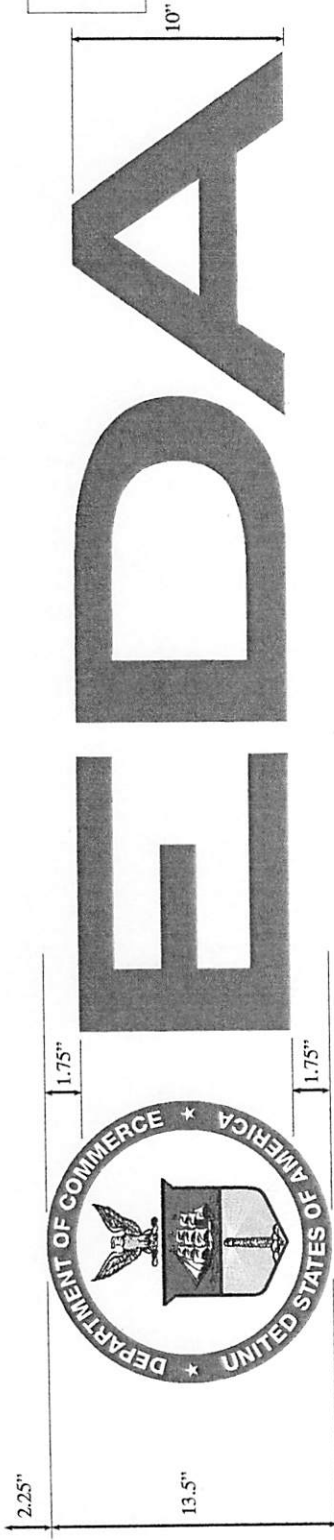

U.S. DEPARTMENT OF COMMERCE ECONOMIC DEVELOPMENT ADMINISTRATION

In partnership with

<EDA Grant Recipient Name>

- 2.0"
- 1.5"
- 4.0"
- 3.0"
- 3.0"
- 3.75"
- 3.0"
- 4.25"
- 2.0"
- 1.75"
- 4.0"

EDA – EXECUTED CONTRACT DOCUMENT CHECKLIST

Project No. _____ Grant Recipient/Location _____

Contractors Name _____ Contract Amount _____

Adv. Date _____ Award Date _____ Contract Date _____

Project Description _____

NO YES

1. Contract Documents: Complete set of executed contract documents.

NO YES

2. Contract Form: Recipient's standard A/E's standard Prof. Association
Contract completely filled out, signed and dated.

NO YES

3. Performance and Payment Bonds:

a. Written for 100% of the contract amount.

b. Completely filled and properly signed and dated.

c. Date of bond does not precede the date of the contract.

d. Security company authorized by Federal and State laws for applicable State.

e. All bonds are supported by a signed and dated Power of Attorney,
Issued by the Security Company.

NO YES

4. Certificate of Attorney: (ED-126)

Properly filled out, signed and dated. The date should not precede any date used within the executed contract document package.

NO YES

5. Insurance:

a. Public Liability Expires _____

b. Property Damage Expires _____

c. Vehicular Liability Expires _____

d. Workmen's Compensation Expires _____

(as required by State or Local law)

NO YES N/A

e. Builder's Rick Insurance Expires _____

*Insurance on the completed value basis on the insurable portion of the project.

NO YES

f. Contractor's insurance certificate must include a provision showing that the insurance covered by the certificate will not be cancelled or materially altered except after at least ten (10) days written notice has been furnished to the owner.

NO YES

6. An executed copy of the Certification Regarding Lobbying, from the contractor as required by Section 1352, Title 31, of the U.S. Code, if not previously submitted.

NO YES

7. A copy of the Recipient's Notification of Award of Prime Contracts to the Director, Office of Federal Contract Compliance Programs (OFCCP), in response to the requirements of E.O. 11246. Refer to EDA Bid Award Approval Letter for this requirement.

Submitted by: _____ Date: _____

CERTIFICATION REGARDING LOBBYING

Certification for Contracts, Grants, Loans, and Cooperative Agreements

The undersigned certifies, to the best of his or her knowledge and belief, that:

(1) No Federal appropriated funds have been paid or will be paid, by or on behalf of the undersigned, to any person for influencing or attempting to influence an officer or employee of an agency, a Member of Congress, an officer or employee of Congress, or an employee of a Member of Congress in connection with the awarding of any Federal contract, the making of any Federal grant, the making of any Federal loan, the entering into of any cooperative agreement, and the extension, continuation, renewal, amendment, or modification of any Federal contract, grant, loan, or cooperative agreement.

(2) If any funds other than Federal appropriated funds have been paid or will be paid to any person for influencing or attempting to influence an officer or employee of any agency, a Member of Congress, an officer or employee of Congress, or an employee of a Member of Congress in connection with this Federal contract, grant, loan, or cooperative agreement, the undersigned shall complete and submit Standard Form-LLL, "Disclosure of Lobbying Activities," in accordance with its instructions.

(3) The undersigned shall require that the language of this certification be included in the award documents for all subawards at all tiers (including subcontracts, subgrants, and contracts under grants, loans, and cooperative agreements) and that all subrecipients shall certify and disclose accordingly. This certification is a material representation of fact upon which reliance was placed when this transaction was made or entered into. Submission of this certification is a prerequisite for making or entering into this transaction imposed by section 1352, title 31, U.S. Code. Any person who fails to file the required certification shall be subject to a civil penalty of not less than \$10,000 and not more than \$100,000 for each such failure.

Statement for Loan Guarantees and Loan Insurance

The undersigned states, to the best of his or her knowledge and belief, that:

If any funds have been paid or will be paid to any person for influencing or attempting to influence an officer or employee of any agency, a Member of Congress, an officer or employee of Congress, or an employee of a Member of Congress in connection with this commitment providing for the United States to insure or guarantee a loan, the undersigned shall complete and submit Standard Form-LLL, "Disclosure of Lobbying Activities," in accordance with its instructions. Submission of this statement is a prerequisite for making or entering into this transaction imposed by section 1352, title 31, U.S. Code. Any person who fails to file the required statement shall be subject to a civil penalty of not less than \$10,000 and not more than \$100,000 for each such failure.

* APPLICANT'S ORGANIZATION	
Turner Plumbing, Inc.	
* PRINTED NAME AND TITLE OF AUTHORIZED REPRESENTATIVE	
Prefix: <input type="text"/>	* First Name: <input type="text" value="Ricky"/> Middle Name: <input type="text"/>
* Last Name: <input type="text" value="Turner"/>	Suffix: <input type="text"/>
* Title: <input type="text" value="President"/>	
* SIGNATURE: <input type="text" value="Ricky Turner"/> Digitally signed by Ricky Turner Date: 2017.07.07 14:54:33 -0500	* DATE: <input type="text" value="07/07/2017"/>

EXHIBIT J

CERTIFICATIONS REGARDING DEBARMENT, SUSPENSION, INELIGIBILITY AND VOLUNTARY EXCLUSION-LOWER TIER COVERED TRANSACTIONS AND LOBBYING

Applicants should refer to the regulations cited below to determine the certification to which they are required to attest. Applicants should also review the instructions for certification included in the regulations before completing this form. Signature on this form provides for compliance with certification requirements under 15 CFR Part 26, "Governmentwide Debarment and Suspension (Nonprocurement)" and 15 CFR Part 28, "New Restrictions on Lobbying."

1. DEBARMENT, SUSPENSION, INELIGIBILITY AND VOLUNTARY EXCLUSION-LOWER TIER COVERED TRANSACTIONS

As required by Executive Order 12549, Debarment and Suspension, and implemented at 15 CFR Part 26, Section 26.510, Participants responsibilities, for prospective participants in lower tier covered transactions (except subcontracts for goods or services under the \$25,000 small purchase threshold unless the subtier recipient will have a critical influence on or substantive control over the award), as defined at 15 CFR Part 26, Sections 26.105 and 26.110 -

(1) The prospective lower tier participant certifies, by submission of this proposal, that neither it nor its principals is presently debarred, suspended, proposed for debarment, declared ineligible, or voluntarily excluded from participation in this transaction by any Federal department or agency.

(2) Where the prospective lower tier participant is unable to certify to any of the statements in this certification, such prospective participant shall attach an explanation to this proposal.

2 LOBBYING

As required by Section 1352, Title 31 of the U.S. Code, and implemented at 15 CFR Part 28, for persons entering into a grant, cooperative agreement or contract over \$100,000 or a loan or loan guarantee over \$150,000 as defined at 15 CFR Part 28, Sections 28.105 and 28.110, the applicant certifies that to the best of his or her knowledge and belief, that:

(1) No Federal appropriated funds have been paid or will be paid, by or on behalf of the undersigned, to any person for influencing or attempting to influence an officer or employee of any agency, a Member of Congress, an officer or employee of Congress, or an employee of a Member of Congress in connection with the awarding of any Federal contract, the making of any Federal grant, the making of any Federal loan, the entering into of any cooperative agreement, and the extension, continuation, renewal, amendment, or modification of any Federal contract, grant, loan, or cooperative agreement.

(2) If any funds other than Federal appropriated funds have been paid or will be paid to any person for influencing or attempting to influence an officer or employee of any agency, a Member of Congress, an officer or employee of Congress, or an employee of a member of Congress in connection with this Federal contract, grant, loan, or cooperative agreement, the undersigned shall complete and submit Standard Form-LLL, "Disclosure Form to Report Lobbying," in accordance with its instructions.

(3) The undersigned shall require that the language of this certification be included in the award documents for all subawards at all tiers (including subcontracts, subgrants, and contracts under grants, loans, and cooperative agreements) and that all subrecipients shall certify and disclose accordingly.

This certification is a material representation of fact upon which reliance was placed when this transaction was made or entered into. Submission of this certification is a prerequisite for making or entering into this transaction imposed by section 1352, title 31, U.S. Code. Any person who fails to file the required certification shall be subject to a civil penalty of not less than \$10,000 and not more than \$100,000 for each such failure.

Statement for loan Guarantees and Loan Insurance

The undersigned states, to the best of his or her knowledge and belief, that:

If any funds have been paid or will be paid to any person for influencing or attempting to influence an officer or employee of any agency, a Member of Congress, an officer or employee of Congress, or an employee of a Member of Congress in connection with this commitment providing for the United States to insure or guarantee a loan, the undersigned shall complete and submit Standard Form-LLL, "Disclosure Form to Report Lobbying," in accordance with its instructions.

Submission of this statement is a prerequisite for making or entering into this transaction imposed by section 1352, title 31, U.S. Code. Any person who fails to file the required statement shall be subject to a civil penalty of not less than \$10,000 and not more than \$100,000 for each such failure.

As the duly authorized representative of the applicant, I hereby certify that the applicant will comply with the above applicable certification(s).

NAME OF APPLICANT

Turner Plumbing, Inc.

AWARD NUMBER AND/OR PROJECT NAME

04-79-06835/BUSINESS RESOURCE CENTER (THE EDGE)

PRINTED NAME AND TITLE OF AUTHORIZED REPRESENTATIVE

Ricky Turner, President

SIGNATURE

Ricky Turner

DATE

07/07/2017

Digitally signed by Ricky Turner
Date: 2017.07.07 14:54:00 -05'00'

STATE OF ALABAMA



County
TUSCALOOSA



LICENSE NO.
3108

CONTROL NO.
3493328

ACCOUNT NO.
2711 2017

10:41 am trp

ISSUED TO:

LICENSE YEAR
2016 - 2017

TURNER PLUMBING
TURNER RICKY G
PO BOX 1276
TUSCALOOSA AL 35403

DATE ISSUED		
11	1	16
MO	DAY	YR

LICENSE TYPE	
STORE LICENSE	
CHAIN STORE LICENSE	
OCCUPATIONAL LICENS	X

BUSINESS LOCATION:

TURNER PLUMBING
7532 OLD JUG FACTORY RD
DUNCANVILLE AL 35456

EXPIRES
September 30, 2017

SECTION	BUSINESS TYPE	LICENSE AMOUNT	FEE	PENALTY	CITATION	INTEREST	ABA TOTAL
084-001	contractor over 200,000	\$375.00	\$1.00	\$0.00		\$0.00	\$376.00

TRANSFER OF LICENSE

Evidence having been adduced before me that a bona fide sale of the business by this certificate has been made by licensee, this license is transferred to said purchaser.

Name of Purchaser

Issuing Authority

Thomas L. White Jr.
State Comptroller

Julie P. Magee
Commissioner of Revenue

Jeff Brown, License Commissioner
Issuing Authority

TOTAL	\$376.00
MAIL FEE	\$2.00
TOT WITH MAIL FEE	\$378.00

Request for Taxpayer Identification Number and Certification

Give form to the
 requester. Do not
 send to the IRS.

Print or type
See Specific Instructions on page 2.

Name (as shown on your income tax return) Turner Plumbing, Inc.	
Business name, if different from above	
Check appropriate box: <input type="checkbox"/> Individual/Sole proprietor <input checked="" type="checkbox"/> Corporation <input type="checkbox"/> Partnership <input type="checkbox"/> Limited liability company. Enter the tax classification (D=disregarded entity, C=corporation, P=partnership) ▶ <input type="checkbox"/> Exempt payee <input type="checkbox"/> Other (see instructions) ▶	
Address (number, street, and apt. or suite no.) P.O. Box 1276	Requester's name and address (optional)
City, state, and ZIP code Tuscaloosa, AL 35403	
List account number(s) here (optional)	

Part I Taxpayer Identification Number (TIN)

Enter your TIN in the appropriate box. The TIN provided must match the name given on Line 1 to avoid backup withholding. For individuals, this is your social security number (SSN). However, for a resident alien, sole proprietor, or disregarded entity, see the Part I instructions on page 3. For other entities, it is your employer identification number (EIN). If you do not have a number, see *How to get a TIN* on page 3.

Note. If the account is in more than one name, see the chart on page 4 for guidelines on whose number to enter.

Social security number	
:	:
OR	
Employer identification number	
63	1215811

Part II Certification

Under penalties of perjury, I certify that:

1. The number shown on this form is my correct taxpayer identification number (or I am waiting for a number to be issued to me), and
2. I am not subject to backup withholding because: (a) I am exempt from backup withholding, or (b) I have not been notified by the Internal Revenue Service (IRS) that I am subject to backup withholding as a result of a failure to report all interest or dividends, or (c) the IRS has notified me that I am no longer subject to backup withholding, and
3. I am a U.S. citizen or other U.S. person (defined below).

Certification instructions. You must cross out item 2 above if you have been notified by the IRS that you are currently subject to backup withholding because you have failed to report all interest and dividends on your tax return. For real estate transactions, item 2 does not apply. For mortgage interest paid, acquisition or abandonment of secured property, cancellation of debt, contributions to an individual retirement arrangement (IRA), and generally, payments other than interest and dividends, you are not required to sign the Certification, but you must provide your correct TIN. See the instructions on page 4.

Sign Here	Signature of U.S. person ▶	Date ▶ 04/27/17
------------------	----------------------------	------------------------

General Instructions

Section references are to the Internal Revenue Code unless otherwise noted.

Purpose of Form

A person who is required to file an information return with the IRS must obtain your correct taxpayer identification number (TIN) to report, for example, income paid to you, real estate transactions, mortgage interest you paid, acquisition or abandonment of secured property, cancellation of debt, or contributions you made to an IRA.

Use Form W-9 only if you are a U.S. person (including a resident alien), to provide your correct TIN to the person requesting it (the requester) and, when applicable, to:

1. Certify that the TIN you are giving is correct (or you are waiting for a number to be issued),
2. Certify that you are not subject to backup withholding, or
3. Claim exemption from backup withholding if you are a U.S. exempt payee. If applicable, you are also certifying that as a U.S. person, your allocable share of any partnership income from a U.S. trade or business is not subject to the withholding tax on foreign partners' share of effectively connected income.

Note. If a requester gives you a form other than Form W-9 to request your TIN, you must use the requester's form if it is substantially similar to this Form W-9.

Definition of a U.S. person. For federal tax purposes, you are considered a U.S. person if you are:

- An individual who is a U.S. citizen or U.S. resident alien,
- A partnership, corporation, company, or association created or organized in the United States or under the laws of the United States,
- An estate (other than a foreign estate), or
- A domestic trust (as defined in Regulations section 301.7701-7).

Special rules for partnerships. Partnerships that conduct a trade or business in the United States are generally required to pay a withholding tax on any foreign partners' share of income from such business. Further, in certain cases where a Form W-9 has not been received, a partnership is required to presume that a partner is a foreign person, and pay the withholding tax. Therefore, if you are a U.S. person that is a partner in a partnership conducting a trade or business in the United States, provide Form W-9 to the partnership to establish your U.S. status and avoid withholding on your share of partnership income.

The person who gives Form W-9 to the partnership for purposes of establishing its U.S. status and avoiding withholding on its allocable share of net income from the partnership conducting a trade or business in the United States is in the following cases:

- The U.S. owner of a disregarded entity and not the entity,